



Rail Accident Investigation Branch

# Rail Accident Report



**Derailement of a passenger train at Carmont,  
Aberdeenshire  
12 August 2020**

Report 02/2022  
March 2022

This investigation was carried out in accordance with:

- the Railway Safety Directive 2004/49/EC
- the Railways and Transport Safety Act 2003
- the Railways (Accident Investigation and Reporting) Regulations 2005.

© Crown copyright 2022

You may re-use this document/publication (not including departmental or agency logos) free of charge in any format or medium. You must re-use it accurately and not in a misleading context. The material must be acknowledged as Crown copyright and you must give the title of the source publication. Where we have identified any third party copyright material you will need to obtain permission from the copyright holders concerned. This document/publication is also available at [www.gov.uk/raib](http://www.gov.uk/raib).

Any enquiries about this publication should be sent to:

RAIB	Email: <a href="mailto:enquiries@raib.gov.uk">enquiries@raib.gov.uk</a>
The Wharf	Telephone: 01332 253300
Stores Road	Website: <a href="http://www.gov.uk/raib">www.gov.uk/raib</a>
Derby UK	
DE21 4BA	

This report is published by the Rail Accident Investigation Branch, Department for Transport.

<b>Version</b>	<b>Date</b>	<b>Location of change(s)</b>	<b>Description of change</b>
v1.0	10 March 2022	All	Initial issue

## Preface

The purpose of a Rail Accident Investigation Branch (RAIB) investigation is to improve railway safety by preventing future railway accidents or by mitigating their consequences. It is not the purpose of such an investigation to establish blame or liability. Accordingly, it is inappropriate that RAIB reports should be used to assign fault or blame, or determine liability, since neither the investigation nor the reporting process has been undertaken for that purpose.

RAIB's findings are based on its own evaluation of the evidence that was available at the time of the investigation and are intended to explain what happened, and why, in a fair and unbiased manner.

Where RAIB has described a factor as being linked to cause and the term is unqualified, this means that RAIB has satisfied itself that the evidence supports both the presence of the factor and its direct relevance to the causation of the accident or incident that is being investigated. However, where RAIB is less confident about the existence of a factor, or its role in the causation of the accident or incident, RAIB will qualify its findings by use of words such as 'probable' or 'possible', as appropriate. Where there is more than one potential explanation RAIB may describe one factor as being 'more' or 'less' likely than the other.

In some cases factors are described as 'underlying'. Such factors are also relevant to the causation of the accident or incident but are associated with the underlying management arrangements or organisational issues (such as working culture). Where necessary, words such as 'probable' or 'possible' can also be used to qualify 'underlying factor'.

Use of the word 'probable' means that, although it is considered highly likely that the factor applied, some small element of uncertainty remains. Use of the word 'possible' means that, although there is some evidence that supports this factor, there remains a more significant degree of uncertainty.

An 'observation' is a safety issue discovered as part of the investigation that is not considered to be causal or underlying to the accident or incident being investigated, but does deserve scrutiny because of a perceived potential for safety learning.

The above terms are intended to assist readers' interpretation of the report, and to provide suitable explanations where uncertainty remains. The report should therefore be interpreted as the view of RAIB, expressed with the sole purpose of improving railway safety.

Any information about casualties is based on figures provided to RAIB from various sources. Considerations of personal privacy may mean that not all of the actual effects of the event are recorded in the report. RAIB recognises that sudden unexpected events can have both short- and long-term consequences for the physical and/or mental health of people who were involved, both directly and indirectly, in what happened.

RAIB's investigation (including its scope, methods, conclusions and recommendations) is independent of any inquest or fatal accident inquiry, and all other investigations, including those carried out by the safety authority, police or railway industry.

# Synopsis

## Synopsis

### The accident

- S1 At around 09:37 hrs on Wednesday 12 August 2020, a passenger train collided with debris washed from a drain onto the track near Carmont, Aberdeenshire, following very heavy rainfall. The train, reporting number 1T08, was the 06:38 hrs service from Aberdeen to Glasgow, which was returning towards Aberdeen due to a blockage that had been reported on the line ahead. There were nine people on board, six passengers and three railway employees (one of whom was travelling as a passenger).
- S2 Train 1T08 was travelling at 73 mph (117 km/h), just below the normal speed for the line concerned. The collision caused the train to derail and deviate to the left, before striking a bridge parapet which caused the vehicles to scatter. Tragically, three people died as a result of the accident:
- a) the conductor, Donald Dinnie
  - b) the train driver, Brett McCullough
  - c) a passenger, Christopher Stuchbury.
- S3 The remaining six people on the train were injured.



*The aftermath of the accident (image taken on 13 August 2020)*

### What was the immediate cause of the derailment?

- S4 Train 1T08 derailed because it struck debris washed out from a 15 metre length of steeply sloping drainage trench. This is evidenced by CCTV images from the train, grooves cut through the debris, the absence of derailment marks on the track on the approach to the debris and marks indicating that the leading wheelset had derailed immediately after the debris field.
- S5 The debris mainly comprised gravel with some cobbles and covered the down line for a length of about 10 metres. Estimates made by RAIB after the derailment indicate the maximum depth of debris on the left and right railheads was probably around 170 mm and 135 mm respectively before the train ran through it.

[for details see paragraphs 72 to 81]



*Washout debris covering the track*

### How was the accident investigated?

- S6 The Rail Accident Investigation Branch (RAIB) deployed investigators to the site of the accident to commence a full investigation of the circumstances. RAIB is the UK's body tasked with the independent and expert investigation of rail accidents. RAIB was created by Act of Parliament in 2003 and has extensive legal powers to enable it to perform this role. The RAIB's sole objective is to identify the factors that led to the accident and to make recommendations for the improvement of railway safety.
- S7 In addition to the investigation by RAIB, parallel investigations are being undertaken by Police Scotland, in conjunction with the British Transport Police; and the UK's rail safety regulator, the Office of Rail and Road (ORR).

## The drainage system

S8 The source of the debris that caused the derailment at Carmont was a 'french drain' and the ground immediately surrounding it. This drain had been installed during 2011 and 2012 (the 2011/12 drain) as part of a wider scheme to address a known problem with the stability of the earthworks in this locality. This drain comprised a 450 millimetre (approximately 18 inch) diameter perforated pipe buried in a gravel-filled trench which ran for 306 metres along the edge of a field at the top of a slope that ran down to the railway. The drain then sloped down relatively steeply (at an inclination of 1 in 3) for 53 metres to track level. Catchpits (access chambers, sometimes called manholes) were provided at intervals along the pipe to allow inspection and maintenance of the pipe.

[for details see paragraphs 24 to 27]

### What were the weather conditions before the accident?

S9 It rained heavily in the central belt of Scotland and parts of the Grampian mountains during the early hours of 12 August 2020. At around 05:00 hrs this rain began to extend eastwards to coastal areas around Dundee and then moved northwards up the coast, reaching Carmont at about 05:50 hrs. There was then near-continuous heavy rain at this location until about 09:00 hrs. However, it was dry and sunny with broken cloud by the time train 1T08 approached the accident site around 37 minutes later.

S10 On the morning of 12 August 2020, Met Office analysis of rainfall radar data shows 51.5 mm of rain fell between 05:50 hrs and 09:00 hrs at the Carmont accident site. Based on this amount of rain falling over a 1 km<sup>2</sup> area, the return period for this event is between 100 and 144 years, dependent on the methodology used. This was within a wider area of exceptionally heavy rainfall, described by the Scottish Environment Protection Agency (SEPA) as a rare event, causing severe disruption and significant flooding in central and eastern Scotland on 11 and 12 August 2020.

[for details see paragraphs 41 to 43, and 102]

### Why was material washed out of the drain?

S11 The drainage system at Carmont was constructed during 2011 and 2012. The drainage system was not installed according to the design drawings and a low bund (artificial ridge) was constructed which was not part of the design. Consequently, on the morning of 12 August 2020 surface water flows were concentrated into a short length of the gravel-filled trench, which resulted in gravel and other stony material being washed out of the drainage trench and the area immediately surrounding it.

S12 The trench which contained the drainage pipe was filled with gravel (mainly between 20 mm and 40 mm in size) in accordance with normal practice for french drains. However, the use of this gravel in such a steeply sloping trench increased the likelihood of it being washed away should the water reach the drain as a concentrated flow.

[for details see paragraphs 89 to 113]



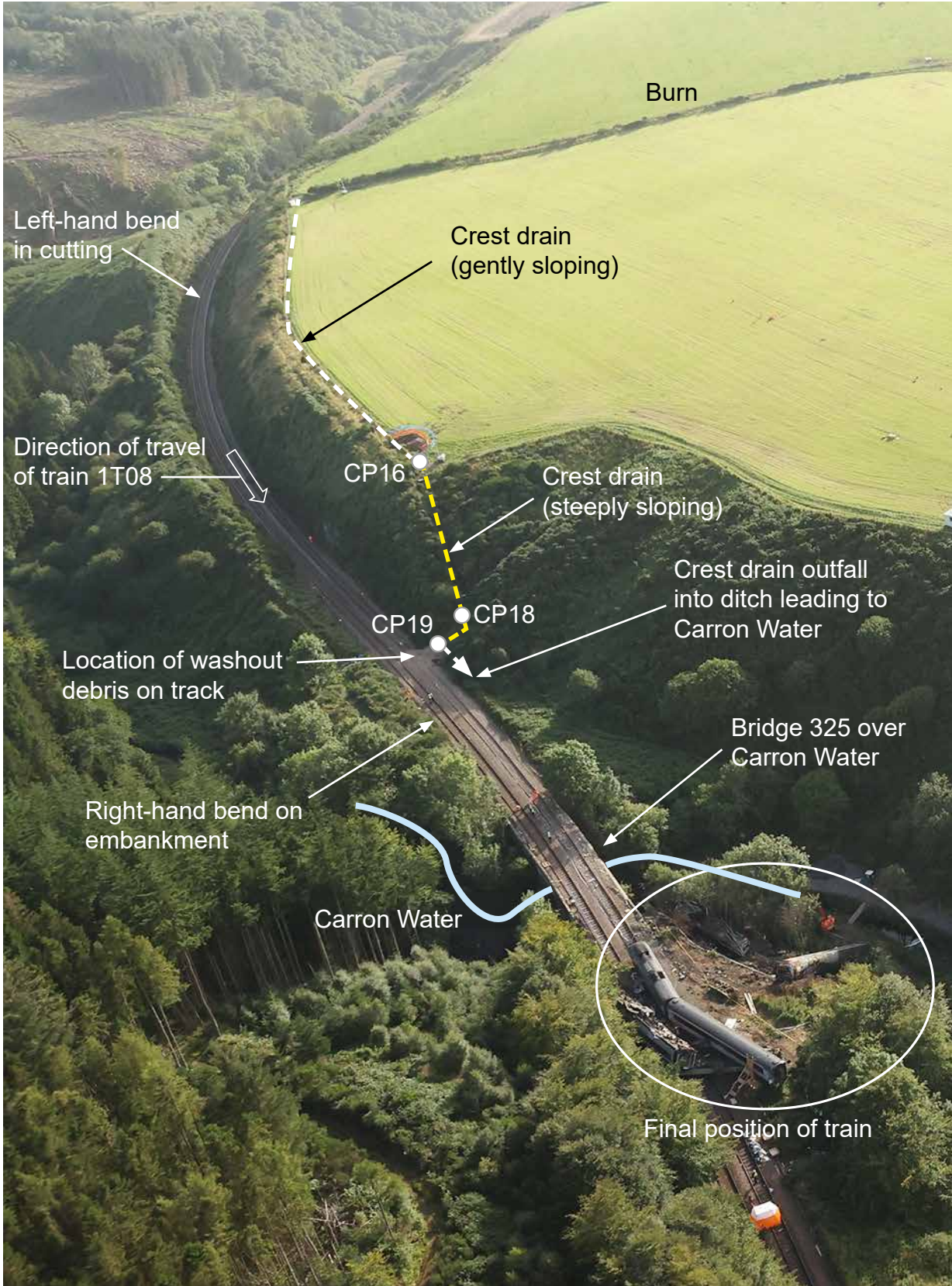

Overview of the drainage system (locations marked 'CP' are catchpits)



*The washout (locations marked 'CP' are catchpits)*

### Was the drain correctly designed?

S13 Modelling undertaken by an engineering consultancy firm appointed by RAIB, AECOM, indicated that the design of the 2011/12 drainage system at Carmont would have been capable of safely accommodating the flow of surface water that occurred on the morning of 12 August 2020 without causing gravel to be washed away down the steeply sloping trench towards the track.

[for details see paragraphs 101 to 113]

### Was the drain correctly constructed?

S14 The company that was contracted to construct the drain, Carillion, did not undertake construction in accordance with the designer's requirements. Consequently, the drainage system was unable to perform as the designer had intended when it was exposed to particularly heavy rainfall on 12 August 2020. The most significant difference between the original design of the drainage system and the final installation was the construction of a bund running across the slope towards the railway and perpendicular to the 2011/12 drain. This bund, which was constructed outside Network Rail's land, had the effect of diverting a large amount of water into a gully so that it all reached the drain at the same location, thereby increasing the propensity for washout of the gravel infill. RAIB found no evidence that the construction of the bund was notified to Network Rail or the designer.

S15 Other differences between the original design and the installed drainage system were probably not causal but nevertheless provide evidence of an absence of control of construction changes. These included:

- a) omission of the intended connection from the existing (pre-2010) drainage into the 2011/12 drain at catchpit number 18
- b) relocating catchpit 18
- c) the lack of geotextile lining to the trench (required to prevent fine soil particles entering the drain and clogging it up) in the area of the washout

- d) cutting holes in the side of catchpits on site so that the holes were significantly larger than the pipes passing through them
- e) a bend in the pipe not coinciding with a catchpit (about one metre downslope of catchpit 18).

RAIB found no evidence that any of these changes were referred to the designer for consideration.

[for details see paragraphs 114 to 154]

#### Why was the issue not spotted and corrected during construction?

- S16 The contractual arrangements between Network Rail and Carillion meant that Carillion was responsible for the delivery of works in accordance with designs approved by Network Rail, together with amendments agreed through formal processes during the construction phase of the scheme. There is no evidence that changes such as the construction of the bund and omission of the connections from the existing drainage to catchpit 18 were dealt with as part of a formal process. Changes of this type should have been referred to Arup (as the designer). However, its records, supplemented by witness evidence, indicate that no such reference was made.
- S17 Network Rail's audit regime at the time of the drain's construction did not include audits likely to detect design modifications implemented on site without proper change control.
- S18 Network Rail's project team were probably unaware that the 2011/12 drain was significantly different from that intended by the designer and therefore did not take action. Had they been aware of this, it is possible that the consequent risk would have been recognised and remedial actions taken. Although Network Rail had a project team, they were not required by Network Rail business processes to check that the drain was being installed in accordance with the design. They therefore relied on a contractual assurance process that required Carillion to refer proposed changes to the designer, Arup, for approval.
- S19 Preparation and retention of 'as-built' drawings of newly constructed assets are required to assist future maintenance of the asset. Depending on how these are prepared, they can provide an opportunity for the designer to recognise inappropriate design modifications. RAIB found no evidence of any such drawings being submitted to the designer or Network Rail.
- S20 It is possible that preparation of as-built drawings would have triggered the transfer of the newly constructed asset to the asset maintenance team. These drawings are generally considered an essential part of the health and safety (H&S) file required by the Construction (Design and Management) Regulations 2007. There is no evidence that this file was prepared for the Carmont project. Furthermore, out of a total of 64 projects sampled by RAIB, more than half were missing any trace of an H&S file. In a sample of eleven drainage projects considered by RAIB, five were not transferred into the asset management system.

[for details see paragraphs 155 to 184 and 287 to 297]

### Who knew that the gravel surface of the 2011/12 drain was eroding?

- S21 In December 2012, shortly after the drain was completed, but before the associated fencing work was finished, the landowner visited the sloping section of drain following a period of heavy rain. During this visit, he took a photograph of the steeply sloping section of drain upslope of catchpit 18 showing water flowing from a side channel and slight erosion to the gravel surface of the 2011/12 drain. The landowner stated that he passed this photograph to Carillion or Network Rail. No evidence has been found relating to receipt of the image or action being taken in response to it. It is likely that this erosion was visible when Network Rail and Carillion staff inspected the site in March 2013.
- S22 It is very unlikely that the slight erosion of the gravel surface would have been immediately recognised as a precursor to a sudden washout affecting railway safety. However, this was clear evidence of a problem requiring action such as repair, monitoring and/or reference to the drain designer. This was a missed opportunity to recognise the effect of the bund on water flows.

[for details see paragraphs 185 to 188]

### Why was the issue not spotted and corrected following routine inspections?

- S23 Information about the section of the drainage system nearest the track at Carmont was held in Network Rail's infrastructure maintenance database (Ellipse). When construction was completed, the remainder of the Carmont drainage system should have been, but was not, entered into Ellipse to trigger routine inspection and maintenance activities. This did not happen due to non-implementation of Network Rail's procedures for introducing new assets onto infrastructure. It is possible that this was related to the absence of 'as-built' drawings (paragraph S19). Since Network Rail's asset managers were unaware of the upper part of the drainage system, no inspection regime was established (although the lower part of the drain was inspected in May 2020). RAIB found no evidence that Network Rail undertook any inspection of the upper parts of the drainage system in the period between the inspection of the completed works in March 2013 and the accident in August 2020.
- S24 The previous rainfall event in December 2012 (paragraph S21) caused drain surface erosion over a relatively small area. Since there may well have been no obvious indication that the defect could suddenly become a significant washout, it is not evident that this extent of damage would have been considered sufficient to trigger remedial action had it been detected by a routine inspection by maintenance teams. Furthermore, it is not possible to determine whether any remedial works would have been sufficient to prevent the washout on 12 August 2020.
- S25 The earthwork at Carmont is described by Network Rail as a 'mixed' cutting because it is formed of both soil and rock. RAIB observes that Network Rail's standard relating to the examination of this type of cutting was open to differing interpretations, and so left a potential gap in the management of risk from the soil components of these earthworks. Although it was generally understood by local examiners that it was desirable to traverse the slope of a mixed cutting to view it from the bottom and top, the inability to do so was not always reported to Network Rail.

[for details see paragraphs 275 to 286 and 584 to 598]

## Railway operations

- S26 Northbound train movements on the section of railway where the accident occurred are signalled from Carmont signal box, which is located near the settlement of Newmill, about 2.4 km (1.5 miles) from the site of the accident. The overall control of the railway, including the response to severe weather, was the responsibility of the Scotland route control room ('route control'), located at the West of Scotland Signalling Centre in Cowlares, Glasgow. This is an integrated control arrangement staffed by both Network Rail and ScotRail staff.
- S27 The train involved in the accident, train 1T08, was the 06:38 hrs service timetabled to run from Aberdeen to Glasgow Queen Street. On the morning of 12 August 2020, it was planned to terminate train 1T08 at Dundee because of obstructions on the line ahead. However, at about 07:01 hrs, just after passing the signal box at Carmont, train 1T08 was instructed to stop due to a landslip obstructing the line ahead that had been reported by the driver of another train.
- S28 After the landslip had been reported, Scotland route control decided that train 1T08 should return to Stonehaven to avoid it being stranded remote from a station. This movement required the train to pass from the southbound line to the northbound line via crossover points near to Carmont signal box. Since the points were required to be secured to enable this movement, it was 09:28 hrs before the signaller was able to authorise the train to proceed towards Stonehaven.

[for details see paragraphs 44 to 58]

### What did the railway know about the weather conditions on the 12 August 2020?

- S29 During the night of 11/12 August 2020, the weather had caused multiple failures and other problems on the railway infrastructure through Scotland's central belt and eastern areas. The cumulative effect of these failures was such that by 05:00 hrs, the only unaffected main route in Scotland was the line from Inverness to Dundee via Aberdeen. During the very early part of the morning, trains operated over this route without encountering weather-related problems.
- S30 Shortly before 07:00 hrs, control began to receive information about weather-related issues between Aberdeen and Dundee, and at 07:01 hrs, train 1T08 was brought to a stand near Ironies Bridge south of Carmont signal box, because of a landslip that had been reported on the line ahead. There was near-continuous heavy rain in the area around Carmont between 05:50 hrs and 09:00 hrs.

[for details see paragraphs 44 to 58]

### Did anyone know about the washout at the site of the accident?

- S31 The last train to pass the site of the accident was train 2B13, the 06:39 hrs service from Montrose to Inverurie, at about 07:07 hrs. The driver saw nothing of concern on the journey. Modelling of water flows indicates that the washout probably occurred between 08:15 hrs and 09:00 hrs.

[for details see paragraphs 59 and 254]

Why was the train travelling at just under its normal permitted speed of 75 mph?

S32 At the time there was no written process that required train 1T08 to be instructed to run at a lower speed on its journey between Carmont and Stonehaven following an intense rainfall event, and no such instruction was given by route control or the signaller. Consequently, normal railway rules applied to the train movement.

S33 During the conversation between the driver of train 1T08 and the signaller at Carmont, the signaller stated that the line was 'fine' and that the driver could proceed at normal speed.

S34 The driver then drove the train towards Stonehaven, accelerating to just below its normal speed, as permitted by the railway's Rule Book on a line that was not known to be obstructed.

[for details see paragraphs 246 to 257]

What actions did operations control take in response to the extreme rainfall events on 12 August 2020?

S35 By 09:00 hrs, around 30 minutes before the return journey of train 1T08, four obstructions of the railway within 11 miles (17.7 km) of Carmont signal box had been reported to route control. These were:

- a landslide at Ironies Bridge which had led to train 1T08 being stopped
- flooding at Ironies Bridge
- flooding at Newtonhill (north of Carmont)
- a landslide near Laurencekirk station (south of Carmont).

S36 Despite this, no instruction was given to the driver or Carmont signaller that train 1T08 should run at reduced speed or that it should be used to examine the line. At the time, there was no clearly defined process that required any such precaution in these circumstances.

[for details see paragraphs 225 to 235]

Did controllers have the resources, information, procedures and training needed to manage extreme rainfall events of the type that occurred on 12 August 2020?

S37 RAIB found evidence that the Scotland route control team was under severe workload pressure on the morning of 12 August 2020, because of the volume of concurrent weather-related events in Scotland (such as the canal breach at Polmont). However, despite the severe nature of the disruption to Scotland's railway infrastructure, no additional resource had been obtained for the control room and the senior management 'gold command' structure had not been established to relieve the pressure on the controllers.

S38 RAIB's investigation also found that controllers in Scotland, and elsewhere, had not been given sufficient guidance or training to enable them to effectively manage complex situations of the type encountered on the morning of 12 August 2020.

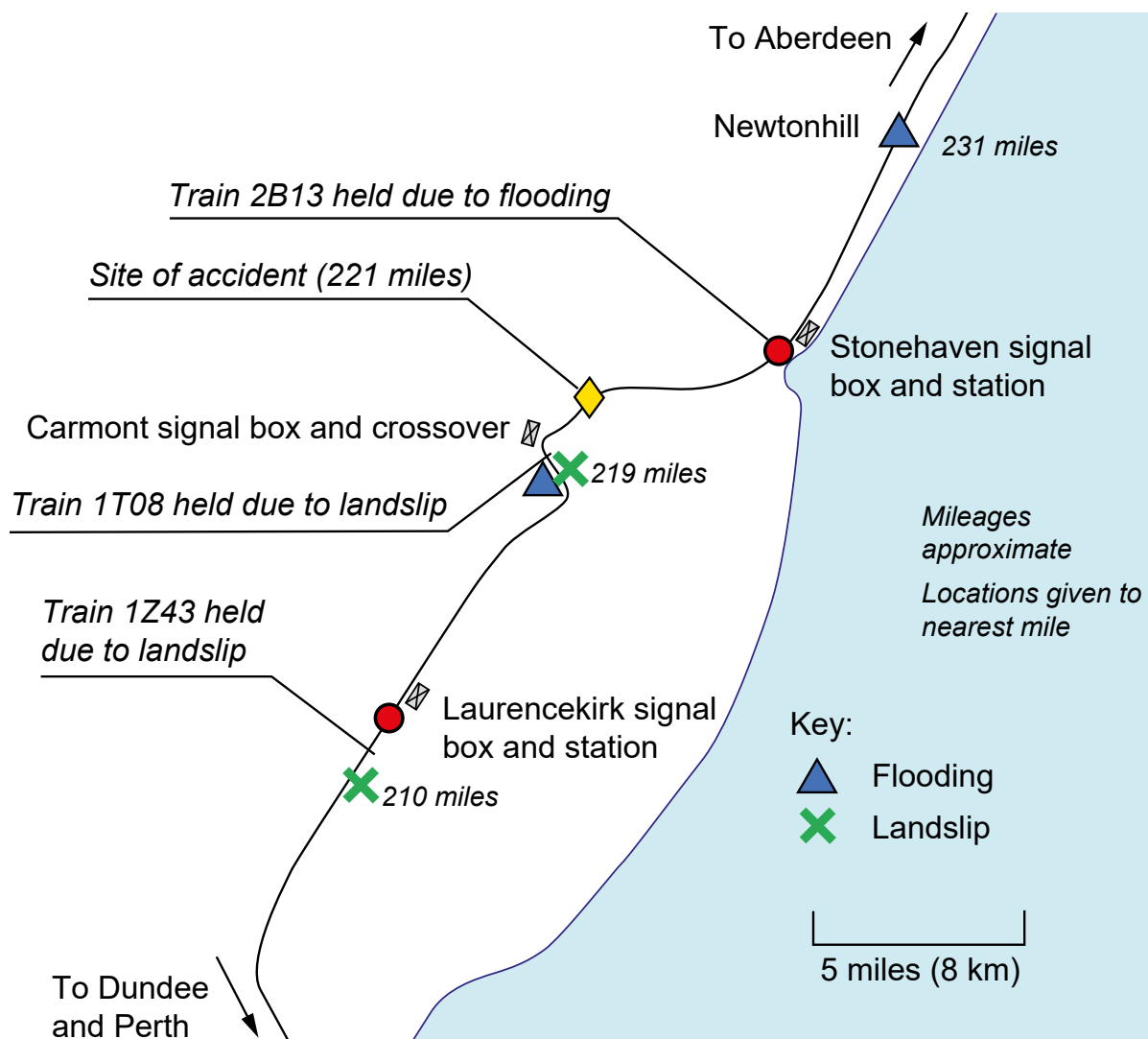

Train positions and known infrastructure failures around Carmont at 09:00 hrs on 12 August 2020

S39 Following previous serious infrastructure failures, in 2015 Network Rail had procured access to a computer tool, the Network Rail Weather Service (NRWS), which was capable of being configured to provide short-range weather forecasts and real-time data on weather conditions. Although the tool was accessible from the control room, this was not used by controllers as a source of information when managing the response to weather-related events. This was because the NRWS had not been optimally configured for use in such circumstances and controllers had not been provided with the procedures or training needed to exploit its full capabilities. The NRWS was also available to the geotechnical asset management team (see paragraphs S45 to S46).

S40 Even if better use of weather data had been combined with knowledge that very heavy rainfall was a known threat to earthworks throughout Network Rail infrastructure (see paragraphs S42 and S43), it is unclear whether controllers would have asked the signaller to caution train 1T08. Beyond certain high-risk locations (a very small proportion of the railway network), Network Rail's national processes did not include the option of imposing precautionary speed restrictions or other mitigation in areas subject to forecast, or actual, extreme rainfall events. This meant that although Network Rail was well aware of the threat posed by extreme rainfall events, such as summer convective storms, neither the controllers nor the asset management team had any 'ready-made' procedural options to mitigate the risk to infrastructure in such circumstances, except at the locations recognised as high-risk.

[for details see paragraphs 189 to 245]

National standards required the convening of an 'extreme weather action team' (EWAT) meeting - how was this requirement applied in Scotland?

S41 Route control practice meant that formal extreme weather action team (EWAT) meetings were not always convened when required by Network Rail's processes, and no such meeting was called on 11 or 12 August 2020 despite forecasts of severe weather. However, even had an EWAT been convened it is considered unlikely that Network Rail would have taken the actions needed to avoid the accident. This is because Network Rail had not established effective arrangements to manage the consequences of extreme rainfall events that endangered infrastructure not identified as being at high risk.

[for details see paragraphs 298 to 317]

Did Network Rail understand that extreme rainfall events might endanger infrastructure that had not previously been identified as being at high risk?

S42 Network Rail's strategy for mitigating the risk of weather-related infrastructure failure was based on the identification of high-risk locations and concentrating risk mitigation measures, such as the appointment of 'watchmen', at these locations. Network Rail did not consider that the drain at Carmont was at risk of washing out during very heavy rainfall.

S43 Network Rail also understood that extreme rainfall events could pose a more general risk to the integrity of earthworks and structures. This understanding is evidenced by minutes of senior management meetings, published responses to previous RAIB investigations and emails between asset managers and route control in the months before the accident.

[for details see paragraphs 195 to 224]

What action was taken by the geotechnical asset managers?

S44 At the time of the accident, Network Rail had a standard that identified the need for consideration to be given to the dynamic assessment of risk should 'significantly heightened rainfall intensity' mean that parts of the railway not identified as high-risk were susceptible to failure.



S45 The geotechnical asset management team had undertaken to monitor the NRWS on 11 and 12 August 2020, and were checking it a couple of times a day, or on notification from control of some real-time incident or feedback of a problem. Reliance on this notification by route control meant there was a significant risk of a train encountering a landslip before route control (and therefore before the geotechnical team) was aware of a problem.

S46 The NRWS, although not configured to do so easily, could have been used to determine when the geotechnical team should initiate precautions outside locations recognised as high-risk (that is beyond sites shown on the geotechnical assets 'at risk' list). However, Network Rail had not established the rainfall thresholds at which this should be done, and it was impractical for the geotechnical team to determine these in real time during an extreme weather event. Such threshold values were introduced after the accident.

[for details see paragraphs 195 to 224]

## Risk awareness and management assurance

### Did Network Rail appreciate the risk from very heavy rainfall to its earthworks, and associated drainage?

S47 The railway industry's risk assessments had clearly signalled that earthwork/drainage failure due to extreme rainfall was a significant threat to the safety of the railway. However, they had not clearly identified potential areas of weakness in the existing operational mitigation measures.

[for details see paragraphs 374 to 396]

### Did Network Rail know that its risk mitigation measures had not been effectively implemented in route control?

S48 Network Rail's management assurance processes did not highlight the extent of weaknesses in the implementation of extreme weather processes in route controls, or that the controllers lacked the necessary skills and resources to effectively manage complex weather-related situations of the type experienced on 12 August 2020. Consequently, significant areas of weakness in the railway's risk mitigation measures were not fully addressed.

[for details see paragraphs 359 to 373]

### Did Network Rail have an effective strategy to mitigate the risk from extreme rainfall events?

S49 Before the accident at Carmont, Network Rail's overall approach to the management of earthwork/drainage failures due to extreme rainfall events was to:

- a) Examine, evaluate and risk assess earthworks (taking account of drainage assets).
- b) Consider the need for additional works to improve the resilience of earthworks/drainage assets that are considered particularly vulnerable to extreme rainfall events and implement these improvements where appropriate.

- c) Inspect and maintain the condition of earthworks/drainage assets, particularly those considered to pose a higher risk to trains.
- d) Define appropriate mitigation measures to be implemented in case of extreme weather (at the high-risk sites on the 'at risk' list).
- e) Obtain forecasts of weather events, conduct a multi-disciplinary review (known as an EWAT) and trigger implementation of mitigation measures at known high-risk sites.
- f) Monitor the situation during the weather event and conduct further reviews as appropriate.

S50 Network Rail's strategy for the management of risk associated with extreme rainfall events had identified the need to implement engineering works to improve the resilience of high-risk assets. However, the operational response to extreme weather events was critically reliant on the identification of high-risk locations and the introduction of additional control measures at those specific locations.

S51 RAIB observed that the success of the overall approach adopted by Network Rail was reliant on the accuracy of forecasting, the reliability of risk assessment, the deployment of sufficient resource and the ability to monitor rainfall events in real-time. In all of these areas Network Rail had yet to meet its own aspirations. The investigation concluded that:

- a) Although access to enhanced weather forecasting and monitoring technology had been procured, its capabilities were not being fully exploited by the geotechnical asset management and route control teams.
- b) Although risk assessment of earthworks has progressed markedly in the last 20 years, it was, and will always be, an imperfect predictor of failure.
- c) The railway has insufficient resource to entirely overcome the potential for infrastructure failure.

S52 Although Network Rail had taken some steps towards implementing modern technology to help monitor weather conditions and better inform operational decision makers, its capability had not been fully exploited before the accident at Carmont. RAIB observes that the roll-out of a technology-based strategy has real potential to manage the risk from extreme rainfall events, provided those who will rely on it are given suitable procedures and training. Such a strategy, coupled to modern communications equipment, would enable train drivers to be instructed to operate at speeds commensurate with the rainfall-related risk in the locality they are passing through. This would benefit the safety of the line (by restricting train speeds, or suspending operations, when necessary) while reducing the need to impose blanket speed restrictions over areas that are not at significant risk.

S53 RAIB's findings regarding the sufficiency of Network Rail's strategy for managing extreme weather events are consistent with those of the Weather Advisory Task Force chaired by Professor Dame Julia Slingo (see paragraph S92). The task force concluded:

*'The weather alert thresholds, used operationally to mitigate weather-associated risks and manage safe train operations, require a major overhaul. They need to be dynamic in space and time, to be based on multiple predictors and to reflect the variations in exposure and vulnerability across the network.'*

S54 The task force also reflected on the ability of Network Rail to implement effective measures for the management of weather risk:

*'Weather pervades many aspects of Network Rail's operations, beyond daily weather alerts, and with a diverse range of needs. There does not seem to be a central core of expertise - an 'authoritative voice' - that can be drawn on to ensure that weather science and data are used correctly and coherently across the organisation. There also seemed to be a lack of coherence on the procurement of expert weather and flooding services combined with a lack of knowledge of existing, external capabilities that could be levered rather than procuring something new.'*

S55 RAIB concluded that, despite an awareness of the threat, Network Rail had not sufficiently recognised that its existing measures did not fully address the risk from extreme rainfall events, such as summer convective storms. Consequently, areas of significant weakness had not been addressed.

[for details see paragraphs 335 to 358]

#### Had sufficient lessons been learnt from previous incidents involving the failure of earthworks and drainage assets?

S56 Since 2009, RAIB has investigated 11 earthwork failures that resulted in debris being deposited on the railway (excluding events triggered by construction work, vegetation and melting snow). In 2014, RAIB published a class investigation covering a range of landslips, many of which were associated with drainage issues.

S57 RAIB's class investigation and other precursor events demonstrated:

- the potential for events to occur at locations where examinations had not identified a high risk of failure
- the likelihood of rain triggering the event
- the importance of providing an effective drainage system.

S58 Network Rail and RAIB concerns were heightened by the landslip just outside the portal of Watford tunnel, Hertfordshire, in September 2016 that caused the derailment of a train and a subsequent glancing blow, inside the tunnel, between the derailed train and a train on the opposite track. Discussions at the meeting of Network Rail's executive committee and the company's Safety, Health and Environment committee in November 2016 covered a range of issues, including:

- a) the need to review the earthworks and drainage on the approach to Watford tunnel

- b) the use of guard rails to prevent derailed trains from deviating too far from the track at high risk sites such as viaducts, and a need for a review of the strategy and criteria for their fitment
- c) more extensive use of satellite images to identify issues on neighbouring land
- d) the plans for a risk-based review of cutting slopes at tunnel portals, taking into account drainage and water flows.

S59 Despite an awareness of risk, Network Rail had not completed the implementation of additional control measures following previous events involving extreme weather. In particular, Network Rail had yet to implement an effective strategy to address the general threat to the stability of earthworks during, and following, extreme rainfall events, including those that had not been assessed as being at risk. Furthermore, Network Rail had still to complete actions to enhance the capability of operating staff to manage complex operational incidents.

S60 It is possible that better delivery of change in response to safety learning would have resulted in actions that would have prevented, or mitigated, the consequences of the accident at Carmont.

[for details see paragraphs 397 to 452]



*The landslip at Watford tunnel, September 2016*

## The train

S61 The train that derailed at Carmont was a high speed train set (HST) with four coaches and two power cars. HSTs were first introduced into service in the mid-1970s and are generally seen as having a good safety record. Although they pre-date a number of modern standards that are relevant to train behaviour in derailments and collisions, they are authorised to operate on the UK's mainline network. The coaches that formed this particular set had been recently refurbished by Wabtec at its workshops. These works included the provision of power-operated doors.



*The derailed train*

### Why did the train derail when it struck the debris from the washed out drain?

S62 The marks found on the track are consistent with the leading left-hand wheel of the leading power car being lifted up by debris between the wheel and rail and displaced to the left across the head of the rail before falling off the track entirely. At the same time the right-hand wheel dropped into the space between the two rails.

[for details see paragraphs 72 to 81]

### What happened to the train after hitting the washout debris?

S63 The curvature of the track at the location of the derailment was a significant factor in the outcome. Once the train derailed at the washout, the front of the leading power car deviated from the track to the left and put the power car on a collision course with the end of the bridge parapet.

S64 The leading power car collided with the end of the parapet, with its centre line slightly to the right of the parapet centre. The collision knocked a substantial amount of masonry from the end of the parapet before the bogie ran along the top of the parapet, skimming off the coping (upper layer) of masonry. Once the power car ran onto the bridge, its left-hand wheels were no longer supported, causing it to veer off the bridge near its mid-span and down to the embankment below. It came to rest on its left-hand side and at an angle with its leading end around seven metres below track level. It is likely that the movement of the leading power car to the left dragged the leading end of the following coach to the left.

S65 Beyond the bridge, other topographical features aggravated the amount of jack-knifing and general vehicle scatter. The first passenger coach came to rest on its roof, almost at right angles to the track. The second passenger coach came to rest overturned onto its roof with its trailing end on top of the first coach and facing the direction of travel. The third passenger coach ran down the steep embankment to the left side of the railway, came to rest on its right-hand side and subsequently caught fire. The fourth passenger coach remained upright and came to rest with its leading end on top of the first coach. The trailing power car remained upright on the down line, still coupled to the rear of the fourth coach.

[for details see paragraphs 454 to 459]

#### What more could be done to prevent trains derailing when they hit debris on the track?

S66 Lifeguards on rail vehicles are heavy metal brackets fitted immediately in front of the leading wheels of a train. Their purpose is to prevent small obstacles getting under the leading wheels and causing derailment. The HST lifeguards were less robust than those on more modern trains. Although a stronger modern lifeguard might have been better able to move sufficient washout debris out of the path of the leading wheelset, RAIB had insufficient evidence to determine the likelihood that this would have prevented the derailment.

[for details see paragraphs 267 to 274]

#### What could be done to keep trains closer to the track after they derail?

S67 At the time of the derailment, no guard rails were installed on the approach to and over the bridge at Carmont (although they were added after the accident). The purpose of guard rails is to contain any derailed wheels so that they remain close to the track and do not allow the train to deviate into collision with the infrastructure (for example, tunnel portals and bridge parapets) or trains on adjacent lines. However, to have been effective in containing the lateral deviation of the leading bogie at Carmont, a pair of guard rails would have needed to extend out from the bridge (towards the approaching train) for a minimum distance of around 35 metres. This is considerably further than is required by Network Rail's standard covering guard rails.

[for details see paragraphs 536 to 543]

#### How were the train's occupants harmed in the accident?

S68 The probable causes of the fatal injuries sustained by the people on the train, were:

- secondary impact of the driver with the cab windscreen and interior as the leading power car struck the embankment below the bridge

- loss of survival space in the leading vestibule of the first coach (where the conductor was standing) as the coach overrode the trailing end of the leading power car while on the bridge
- ejection of the passenger through the open gangway at the leading end of the second coach, probably when it struck the wooded bank after it had traversed the bridge and run off to the right-hand side of the track.

S69 The principal cause of serious injury to three of the survivors was secondary impact with the vehicle interiors. The first two coaches both underwent extreme movements and rolled over onto their roofs before they came to rest. These movements would have subjected passengers to accelerations in the vertical, lateral and longitudinal directions, and would have caused them to come into violent contact with the vehicle interior and/or fall out of their seats on the high side and onto the low side as the vehicles rolled over. The two survivors in the leading coach also received multiple cuts and lacerations and were probably ejected from the vehicle as it came to a rest.

[for details see paragraphs 470 to 480]

#### How was the train damaged in the accident?

S70 RAIB carried out a detailed examination of the train wreckage to assess its 'crashworthiness'. Its findings included:

- a) The 'Alliance' couplers between the vehicles were not able to withstand the forces and relative vehicle movements during the derailment. All the vehicles became uncoupled except at the interface of the last coach and the trailing power car. The uncoupling allowed the vehicles to scatter and roll over and increased the risk of secondary impact with the infrastructure and other vehicles and their bogies.

[for details see paragraphs 502 to 503].

- b) The coaches were not fitted with any form of bogie retention in the vertical direction, and this allowed the vehicle bodies to lift off their bogies during the derailment. As a consequence of losing their bogies, three of the coaches were free to slide and roll in an uncontrolled manner (attached bogies tend to resist sliding because they dig into the ballast). The detached bogies also became obstacles in the path of the vehicle bodies, and the second coach probably suffered penetration damage as a result of striking detached bogies.

[for details see paragraphs 504 to 506].

- c) Of the 61 main bodyside windows on the passenger coaches, 22 windows were found to be completely broken through (that is, there was no glass left to provide passenger containment) during a post-accident inspection. Most of the windows that were completely broken through were in areas that had suffered significant bodyside damage, or had failed due to the fire that broke out in the third coach. Examination of the interior of the leading coach showed that many large shards of glass had become detached from the inner laminated pane of the window. Both passengers who survived the accident in the leading coach suffered laceration injuries which may have been caused by these pieces of broken glass.

[for details see paragraphs 518 to 527].

### Was the condition of the train a factor in the extent of the damage?

- S71 The bodysells of the coaches generally performed well in the accident, resulting in only limited loss of survival space and resisting injurious penetration of passenger spaces during impacts with other vehicles and bogies. However, there was complete loss of survival space in the leading vestibule of the leading coach. The vestibule was protected by four body-end 'collision' pillars comprising two gangway pillars either side of the flexible gangway, and two corner pillars next to the doors. All the pillars at the leading end were sheared off at their bases.
- S72 Given the age of the vehicles, it was unsurprising that damaged areas of the coach structures were found to have areas of corrosion. RAIB considered whether the extent of corrosion may have significantly affected the way the coach structures deformed and in particular the loss of survival space observed in the leading coach. However, since the forces applied to the collision pillars in the interaction with the leading power car are not known, the investigation was not able to determine whether or not the original strength of the pillars (that is, without any material loss due to corrosion) would have been sufficient to prevent the loss of survival space that led to the death of the train's conductor.
- S73 The coaches involved in the accident had been extensively refurbished in 2019 by Wabtec. Records for corrosion repairs provided by Wabtec indicate some localised corrosion had been identified on the collision pillars on the leading coach, and repairs had been authorised. At that time, there were no formal criteria for judging the tolerability of the corrosion and the extent of repairs that were required in this area. Instead the need for, and extent of, repairs was based on engineering judgment. There are no photographic records of the work actually done and the pillars were too severely damaged in the accident for a meaningful retrospective assessment of this work.

[for details see paragraphs 491 to 501]

### How was the driver protected from the impact?

- S74 The cab was subjected to severe impact conditions and became detached from the power car. The impact conditions were significantly beyond those in which even modern cabs are designed to provide protection for occupants.
- S75 HST driving cabs are not fitted with seat belts or any other secondary impact protection for the driver, and therefore drivers are vulnerable to injurious impact with the desk structure and windscreen in collisions and derailments. In the past, research work has been carried out to examine the feasibility of better protecting train drivers from injury in case of collision. The accident at Carmont has once again highlighted that train drivers are vulnerable to fatal injuries arising from secondary impact with the cab interior in high energy derailments.

[for details see paragraphs 484 to 490]



### Would a modern train have behaved differently?

S76 A train built to modern crashworthiness standards (those applicable since the introduction of Railway Group Standard GM/RT 2100 in July 1994) would have had a number of design features that are intended to provide better protection for occupants and keep vehicles in line should they collide with an obstacle or derail. These include:

- a) Anti-climb features (either as serrated pads fitted to the vehicle ends or built into the couplers) and energy absorbing vehicle ends to prevent override and consequential uncontrolled structural collapse in collisions.
- b) More robust couplers which are better able to resist the forces which couplers are subjected to in derailments, without failure or uncoupling.
- c) Bogie retention features, so that in an accident, the bogies remain attached to the vehicle bodies as far as is possible.

S77 The refurbished HST that derailed at Carmont was designed and constructed before these standards came into force. While it is not possible to be certain about what would have happened in the hypothetical situation with different rolling stock in the same accident, RAIB considers it more likely than not that the outcome would have been better if the train had been compliant with modern crashworthiness standards.

[for details see paragraphs 528 to 535]

### Would the consequences have been worse if more people were on the train?

S78 Because of the COVID-19 pandemic, there were only nine people on train 1T08 on the morning of 12 August 2020. ScotRail estimated the number of passengers that would have been on train 1T08 in normal times to be between 25 and 50 (three and six times greater than on the day of the accident). The circumstances of the accident and the resulting movements of the vehicles was such that, with normal passenger numbers, the casualty toll would almost certainly have been significantly higher.

[for details see paragraphs 460 and 461]

### What caused the fires in the leading power car and the third coach, and were people endangered?

S79 Post-accident examination of the fuel tank of the leading power car showed it had been ruptured during the accident, and the absence of other readily combustible material indicates that fuel from this tank sustained the fire. Although the investigation did not establish the precise mechanism by which the fire started, it is possible that damage to the fuel system sustained during the accident may have given rise to diesel fuel being spilled or sprayed; this fuel could have ignited on hot surfaces, or as a consequence of arcing or sparks from damage to electrical systems.

S80 The third coach caught fire after coming to rest on the embankment flank with its right-hand side on the ground and sloping downwards so that its leading end was lower than its trailing end. The fire was not apparent to witnesses until around 11:00 hrs (approximately 90 minutes after the accident). Since no one was trapped in the interior of the coach the fire did not endanger human safety.

S81 The fire in the third coach originated in the batteries beneath the floor of the coach and almost certainly was caused by an electrical fault that arose due to the extent of damage to the underframe of the coach. The subsequent spread of the fire was a consequence of the coach coming to rest on its right-hand side on the slope, with its trailing end uppermost. This orientation meant that the fire naturally extended across the underframe and grew towards the trailing end of the coach. A rectangular hole in the floor on the left-hand side, designed to allow air from the air conditioning system into the passenger compartment, was the likely route of the fire into the coach's interior.

[for details see paragraphs 544 to 558]



*Fire damage in the third coach*

## RAIB's conclusions

### Immediate cause

S82 Train 1T08 derailed because it struck washout debris (paragraph 72).

### Causal factors

S83 RAIB's investigation concluded that had the drainage system been installed in accordance with the design, it is highly likely to have safely accommodated the flow of surface water on 12 August 2020. However, as installed, the drainage system was unable to do so (paragraph 91). This occurred because:

- a) The gravel in the drainage trench was vulnerable to washout if large flows of surface water concentrated onto a short length of drain (paragraph 100, **Recommendation 3**).
- b) Carillion did not construct the drain in accordance with the designer's requirements (paragraph 114, **Recommendation 1**).

S84 RAIB also identified the following possible causal factors:

- a) Network Rail's project team were probably unaware that the 2011/12 drain was significantly different from that intended by the designer and therefore did not take action. Had the team been aware of this, it is possible that the consequent risk would have been recognised and remedial actions taken (paragraph 160, **Recommendation 1**).
- b) Network Rail's processes that were intended to ensure a managed transfer of safety-related information from constructor to infrastructure manager were ineffective. Had this managed transfer taken place in accordance with Network Rail's processes, it is possible that the divergence between the design intent and the asset that had been delivered would have been noted and remedial action taken (paragraph 179, **Recommendations 1 and 2**).
- c) No action was taken by Network Rail or Carillion when water flow in gully 1 caused slight erosion to the gravel surface of the new drainage trench before the works were completed. This was a missed opportunity to recognise the effect of the bund on water flows, and is therefore considered to be a possible causal factor in this accident (paragraph 185, **Recommendation 1**).

S85 With regard to railway operations, RAIB identified the following causal factors:

- a) Network Rail did not have suitable arrangements in place to allow timely and effective adoption of additional operational mitigations in case of extreme rainfall which could not be accurately forecast (paragraph 189, **Recommendations 6 and 7**).
- b) Although aware of multiple safety-related events caused by heavy rain, route control staff were not required to, and did not, restrict the speed of train 1T08 northwards from Carmont to Stonehaven (paragraph 225, **Recommendations 6 and 7**).
- c) The signaller and driver were not required to, and consequently did not, restrict the speed of train 1T08 to below that normally permitted (paragraph 246, **Recommendation 6**).

#### Consideration of other issues

S86 The following issues cannot be completely discounted as factors in the Carmont accident, but the available evidence is insufficient to consider them to be causal. In other circumstances, they could have been a factor in an accident.

- a) The HST lifeguards were less robust than those on more modern trains. Although a stronger modern lifeguard may have been better able to move sufficient washout debris out of the path of the leading wheelset to prevent the derailment, RAIB had insufficient evidence to determine the likelihood of this happening (paragraph 267, **Recommendation 14**).
- b) Network Rail's process for initiating the inspection and maintenance of new drainage works had not been correctly applied. Consequently, it is likely that the upper section of the 2011/12 drainage system had never been inspected since its completion. Although RAIB has found no evidence to suggest that such an inspection would have changed the outcome, this cannot be entirely discounted. Whether or not relevant to the accident, the absence of proper inspection of a safety critical asset is of great concern (paragraph 275, **Recommendations 1**).

- c) Neither RAIB or Network Rail could find any trace of the health and safety file for the Carmont drainage works. There is evidence that Network Rail's processes related to the creation and management of health and safety files were not being correctly applied in Scotland and elsewhere in the UK (paragraph 287, **Recommendation 1**).
- d) Custom and practice in Scotland's route control meant that extreme weather action team (EWAT) meetings were not always convened when required by Network Rail's processes, and no such meeting was called on 11 or 12 August 2020 despite forecasts of severe weather. However, even had an EWAT been convened it is considered unlikely that Network Rail would have taken the actions needed to avoid the accident (paragraph 298, **Recommendations 6 and 7**).

### Underlying factors

S87 RAIB's investigation identified the following underlying factors:

- a) Network Rail's management processes had not addressed weaknesses in the way it mitigated the consequences of extreme rainfall events (paragraph 318). The underlying reasons for this were:
  - i. Despite an increasing awareness of the threat, Network Rail had not sufficiently recognised that its existing measures did not fully address the risk from extreme rainfall events, such as summer convective storms. Consequently, areas of significant weakness had not been addressed (paragraph 336, **Recommendations 6 and 10**).
  - ii. Network Rail's management assurance processes did not highlight the extent of any areas of weakness in the implementation of extreme weather processes in route controls, or that the controllers lacked the necessary skills and resources to effectively manage complex weather-related situations of the type experienced on 12 August 2020. Consequently, significant areas of weakness in the railway's risk mitigation measures were not fully addressed (paragraph 359, **Recommendation 8**).
  - iii. The railway industry's risk assessments had clearly signalled that earthwork/drainage failure due to extreme rainfall was a significant threat to the safety of the railway. However, they had not clearly identified potential areas of weakness in the existing operational mitigation measures (paragraph 374, **Recommendation 6 and 10**).
- b) Despite an awareness of the risk, Network Rail had not completed the implementation of additional control measures following previous events involving extreme weather and the management of operating incidents. It is possible that better delivery of change in response to safety learning would have resulted in actions that would have prevented, or mitigated, the consequences of the accident at Carmont (paragraph 397, **Recommendation 9** and Margam report recommendation 6).

### Examination of consequences

S88 When considering the consequences of the accident RAIB considered:

- the circumstances of the derailment, speed, local topography and proximity to a bridge (paragraphs 454 to 459)
- the structural damage to the vehicles (paragraph 462 to 469)
- the unusually low number of people on the train because the accident occurred during the COVID-19 pandemic (paragraphs 460 and 461).

S89 The crashworthiness of the vehicles involved in the derailment (paragraph 481 to 483), and the severity and cause of injuries suffered by those on the train (paragraphs 470 to 480) were examined by RAIB. The findings are presented in the following sections of the report:

- a) driver's cab (paragraphs 484 to 490, **Recommendation 17**)
- b) structure of the coaches and the effect of corrosion (paragraphs 491 to 501, **Recommendation 18**)
- c) couplers and absence of bogie retention on the coaches (paragraphs 502 to 506, **Recommendation 19**)
- d) vehicle interiors and bodyside mounted folding tables (paragraphs 507 to 517, **Recommendation 16**)
- e) window breakage (paragraphs 518 to 527, **Recommendation 15**)
- f) comparison with modern rolling stock (paragraphs 528 to 535, **Recommendation 19**)
- g) guidance of derailed vehicles (paragraphs 536 to 543, **Recommendations 12 and 13**)
- h) fire causation and effects (paragraphs 544 to 558, **Recommendation 20**)
- i) evacuation of survivors and emergency egress (paragraphs 559 to 565, no recommendation).

### Additional observations

S90 Although not linked to the accident on 12 August 2020, RAIB observes that:

- a) Railway industry processes for the operation of route proving trains were poorly defined and inconsistent (paragraph 566, **Recommendation 11**).
- b) Use of the GSM-R radio system by ScotRail staff would have broadcast emergency information to other railway staff more quickly (paragraph 577, **Learning point 1**).
- c) Network Rail's standard relating to the examination of mixed cuttings was open to differing interpretations, and so left a potential gap in the management of risk from soil components of mixed slopes. Although it was generally understood by local examiners that it was desirable to traverse the slope of a mixed cutting to view it from the bottom and top, the inability to do so was not always reported to Network Rail (paragraph 584, **Recommendations 4 and 5**).

### What actions has industry already taken?

S91 The actions that the railway industry has reported taking include:

- A new drainage system, with improved capacity, and with features intended to prevent another washout, was installed to replace the 2011/12 system.
- Guard rails were fitted on both up and down lines on the approach to bridge 325 when the track was re-laid after the accident. The protection includes gathering rails and, on the down line, extends beyond the site of the washout.
- Network Rail stated that, before the accident at Carmont, its project teams had started to review historical projects (up to 10-years old) in Scotland to ascertain whether a health and safety file, if required, had been accepted by the National Records Group (NRG) and stored appropriately; and this process is continuing.
- NR Standard NR/L2/INI/02009 was updated and reissued. This update is intended to strengthen the management of technical queries raised during construction and the process for controlling changes to the design.
- Network Rail introduced expanded drain design requirements in December 2018 which, in addition to enhanced requirements relating to selection of design methodologies, requires consideration of impacts on other assets, such as earthworks and track, during extreme events.
- Scotland's Railway has established a permanently-staffed weather desk position. Network Rail has informed RAIB that suitably qualified people have been recruited to cover this position, which is responsible for monitoring weather conditions and advising controllers on the necessary precautionary actions.
- A process requiring blanket speed restrictions in areas without earthworks on the 'at risk' list was implemented, where considered necessary by Network Rail, throughout its network in September 2020. This process included enhanced use of weather data, including an improved capability to identify convective rainfall which can be difficult to predict until shortly before it falls.
- Network Rail has implemented a number of process changes that are designed to improve the way that it manages its response to recommendations.
- Network Rail has also reported that it is implementing a programme of level 2 audits to check the correct implementation of risk controls that have been introduced in response to RAIB recommendations.
- RSSB has also launched project T1269, 'Development of a system risk model for extreme rainfall events'. The project aims to develop a whole system risk model for these extreme rainfall events. RSSB has also commenced a project to assess the effectiveness of blanket speed restrictions in managing and mitigating risks from trains running into trees or landslips (reference T1252). This considers the effectiveness of current UK practice regarding weather-related speed restrictions, and alternative approaches to such speed restrictions that have proved effective in other countries.
- ScotRail has stated that it intends to change training for conductors working on HSTs so that it will include entering the driving cab and locating the GSM-R equipment.

[for details see paragraphs 619 to 631]

S92 Following the accident at Carmont, and in the light of the likelihood that climate change will exacerbate this risk still further, Network Rail decided to commission two task forces to advise on the ways that it could improve its understanding of earthworks management and potential improvements to its mitigation measures. Lord Robert Mair CBE FREng FRS, a geotechnical expert, led an earthworks management task force to advise Network Rail on how it can improve the management of its earthwork portfolio. Dame Julia Slingo FRS, former chief scientist at the Met Office, led a weather action task force with the objective of better equipping Network Rail to understand the risk of rainfall to its infrastructure.

S93 Neither task force was asked to investigate the accident at Carmont in any detail. However, their findings will inform Network Rail's ongoing asset management and operational mitigation strategies. The work of the task forces therefore complements that of RAIB which relates more closely to the specific factors that contributed to the accident at Carmont.

[for details see paragraphs 632 to 637]

### RAIB's safety recommendations

S94 RAIB has made 20 recommendations for the improvement of railway safety. These are all addressed to the UK's safety authority, the Office of Rail and Road. For each recommendation, RAIB has identified the party or parties that RAIB considers require to take action if the intent of the recommendation is to be met (the 'end-implementers'). Carillion are not identified as an end-implementer since the company is in liquidation.

Rec No.	FINDING	End-implementer	AREA OF RECOMMENDATION [for details see paragraph 638]
1	The drain was not installed as designed	Network Rail	Management of civil engineering construction activities
2	As-built information was not handed over to the maintainer	Network Rail	Ensure that all new works are incorporated into inspection and maintenance regimes
3	The gravel in the drainage trench was washed out when subjected to concentrated flows on a short length	Network Rail	Enhanced design processes for new drainage to ensure that the risk of such washouts is minimised
4	The upper parts of the earthworks at Carmont were not examined	Amey and Network Rail	Review of how earthwork examination processes for 'mixed cuttings' are being implemented

Rec No.	FINDING	End-implementer	AREA OF RECOMMENDATION [for details see paragraph 638]
5	Incomplete earthwork examinations were not notified to Network Rail	Network Rail	Evaluate the adequacy, and ways of improving the clarity, of the relevant standard
6	Network Rail's operational procedures did not adequately address extreme and volatile rainfall events such as summer convective storms	Network Rail	Improved processes for implementing mitigations for weather-related risks
7	The route control room was unable to effectively manage the situation in Scotland on the morning of 12 August 2020	Network Rail	Improve the capability of route control rooms to effectively manage complex, widespread and unusual incidents
8	Scotland's integrated control room had not been subject to adequate audit, monitoring or review	Network Rail	Improve management assurance of route control functions
9	The learning from previous events had not been applied effectively	Network Rail	Identify and address the obstacles to effective implementation of lessons learnt from investigation of accidents and incidents
10	Network Rail's engineering risk analysis assessed operational risk mitigation measures as being 'optimal' – the investigation reveals this not to be the case	Network Rail	Risk assessment of the mitigating control measures that relate to failures of earthworks and drainage
11	Lack of clear and consistent rules about the operation of route proving trains	Network Rail assisted by RSSB and the Rail Delivery Group (RSG)	Clarify the arrangements to be applied for the operation of route proving trains
12	The derailed HST did not stay close to the track after it derailed	RDG and Network Rail, in conjunction with RSSB	Assessment of measures to provide improved guidance to derailed trains
13	The derailed HST did not stay close to the track after it derailed	Network Rail	Review of standards applying to the installation of guard rails at higher risk locations
14	The leading wheels of the HST lifted clear of the rail when running in a relatively shallow debris field	Owners of HST power cars	Investigate the feasibility of strengthening the lifeguards on HST power cars to better protect the wheels from obstacles



Rec No.	FINDING	End-implementer	AREA OF RECOMMENDATION [for details see paragraph 638]
15	Glass in the windows of the HST broke into long and potentially dangerous shards	RSSB	A review of current train glazing standards to minimise the risk of lacerations
16	The bodyside mounted folding tables had sharp edges when folded down	Angel Trains, in conjunction with ScotRail (Note: this recommendation may also apply to owners of vehicles with similar tables)	Modify bodyside mounted folding tables to reduce the risk of injury to passengers in case of accident
17	Protection of train drivers remains a safety concern	RSSB	A review of previous research on fitting secondary impact protection for train drivers (for example, seatbelts and airbags)
18	No clear criteria for the extent of corrosion that is permissible in safety critical areas of rolling stock	Owners of mark 3 coaches and other rolling stock susceptible to significant levels of corrosion	Establish criteria for the allowable extent of corrosion in safety critical areas of rolling stock
19	The damage to the HST was very extensive. A significantly higher casualty toll would have been likely if the train had been heavily loaded with passengers	Operators of HSTs, in consultation with rolling stock owners	Assessment of the additional risk to vehicle occupants associated with the lack of certain modern crashworthiness features on HSTs, and the development of industry guidance for assessing and mitigating the risk associated with the continued operation of HSTs and other types of main line passenger rolling stock designed before the introduction of modern crashworthiness standards in 1994
20	The fire in coach B was associated with the batteries	RSSB	Investigation of alternative designs of batteries and their casings which offer improved fire properties

### What happens next to RAIB's recommendations?

S95 The action of formally addressing the recommendations to the safety authority (ORR) enables it to discharge its duty of ensuring that the end-implementer considers the recommendation and where appropriate takes action in response to the recommendation. The safety authority or the public body is then required to report back to RAIB on the details of the consideration and the action taken or planned, or the reasons why no measures are to be taken to implement the recommendation.

### **Learning point**

S96 RAIB has identified the following important learning point:

- 1 Railway staff are reminded that, if available and they are trained to use it, GSM-R radio is normally the most appropriate way to communicate urgent safety information to signallers.

# Report

# Derailment of a passenger train at Carmont, Aberdeenshire, 12 August 2020

## Contents

	Page
<b>Introduction</b>	41
<b>The accident</b>	42
Summary of the accident	42
Context	42
Location	42
Organisations involved	43
Trains involved	46
Railway infrastructure	47
Staff involved	50
External circumstances	52
<b>The sequence of events</b>	56
Events preceding the accident	56
Events during the accident	61
Events following the accident	65
<b>Analysis</b>	67
Identification of the immediate cause	67
Pre-accident infrastructure condition	70
Maintenance status of the train	71
Identification of causal factors	71
Design and performance of the drainage system	72
Washout gravel from drainage trench	82
Post-accident analysis	82
Washout design consideration	89
Summary of rainfall and drainage analyses	90
Construction activities	90
Drain planning	90
Drain installation	92
Changes to the designer's requirements	93
Construction of a bund	93
Connection of existing funnel drainage into catchpit 18	95

	Page
Relocating catchpit 18	97
Lack of geotextile lining to trench	98
Site-cut holes in catchpits	100
Locally dug fill upslope of CP19	101
Bend in pipe	102
As-built condition of the drainage pipe	102
Control of construction changes	102
Network Rail's role during construction of the drain	103
Network Rail audits of Carillion	105
Project completion	106
As-built drawings and records	106
Drain erosion before project completion	107
The risk to train operation from summer convective storms	109
Operational management of Scotland's Railway	109
Weather-related management processes	110
Responding to the weather forecast for 12 August 2020 and similar events	115
Route control staff actions in response to events overnight 11 August into 12 August	122
Holistic overview of the weather situation	122
Stranded train risk assessment	123
Resources available for route control staff	124
Network Rail route control staff competency requirements	125
The actions of the signaller and driver	126
Consideration of factors affecting fitness for duty	129
Fatigue	129
Other factors	129
Consideration of other issues	130
Protection of the front wheelset	130
Maintenance and inspection of the drain	133
Health and safety files	136
The health and safety file for the drainage works at Carmont	136
Health and safety files, and transfer of assets into maintenance, at other locations	137
'Extreme weather action team' (EWAT) meetings	138
Identification of underlying factors	142

	Page
The management of extreme rainfall events	142
Background to Network Rail’s senior management processes	142
Network Rail’s national team (HQ)	142
Network Rail and the ScotRail Alliance	143
Senior management’s awareness of extreme weather issues	144
Network Rail’s approach to the management of extreme rainfall events	146
Network Rail’s measures for the management of extreme weather events	147
The ‘Weather Resilience and Climate Change Adaptation Strategy’	147
The identification of ‘at risk’ earthworks	148
Network Rail’s overall approach to the management of earthwork failures due to extreme rainfall	148
Adequacy of Network Rail’s response to extreme weather	151
Management assurance of Network Rail operational control functions	152
Audits of operational control functions	153
Management awareness of working practices in Scotland’s route control	154
Risk awareness	155
Safety decision making in the railway industry	155
Number of earthwork/drainage failures	155
Risk assessment	156
Engineering risk analysis	161
Corporate learning	162
Previous earthwork and weather-related events	162
RAIB extreme weather and earthwork recommendations	167
Landslips class investigation - Recommendation 3	167
Lamington - Recommendation 3	168
Landslips class investigation - Recommendation 5	169
Route control management	170
Lewisham	170
Baildon	171
Corby	172
Dock Junction/Kentish Town	172
Discussion	172
Other rail events	172
Learning from other industries	173

	Page
Network Rail audit and reviews of its recommendation management process	174
Summary of issues associated with Network Rail's corporate learning	175
Examination of consequences	176
The circumstances of the derailment	176
Low passenger numbers due to the COVID pandemic	177
Structural damage to the vehicles	178
Causes of injury	182
Crashworthiness performance of vehicles	185
Driver's cab	185
Vehicle structures	187
Corrosion	188
Couplers	190
Bogie retention	191
Vehicle interiors	192
Folding tables	192
Seat belts	193
Window breakage	194
Comparison with modern rolling stock	197
Guidance of derailed vehicles	199
Fires	202
Fire in leading power car	202
Fire in coach B	203
Evacuation	206
Emergency egress	208
Observations	209
Route proving	209
Emergency communication	211
Driver of 2B13	211
Conductor travelling as passenger	211
Earthworks inspections	212
The role of the safety regulator	214
Earthwork management	215
Construction activities	216
Recommendation handling	216

	Page
Other occurrences	217
<b>Summary of conclusions</b>	<b>218</b>
Immediate cause	218
Causal factors	218
Consideration of other issues	219
Underlying factors	219
Examination of consequences	220
Additional observations	221
<b>Actions reported as already taken or in progress relevant to this report</b>	<b>222</b>
Actions reported that address factors which otherwise would have resulted in a RAIB recommendation	222
Other reported actions	222
Network Rail Task Forces	224
<b>Recommendations and learning point</b>	<b>225</b>
Recommendations	225
Learning point	235
<b>Appendices</b>	<b>238</b>
Appendix A - Glossary of abbreviations and acronyms	238
Appendix B - Glossary of terms	240
Appendix C - Investigation details	244
Appendix D – Weather-related disruption in Scotland on 11/12 August 2020	246
Appendix E - Accident sequence	248
Appendix F - Track and bridge 325 - condition and damage	260
Appendix G - Historical and land drainage	271
Appendix H - Analysis of water and debris flows on 12 August 2020	275
Appendix J - Weather forecast for Scotland issued 02:51 hrs 12 August 2020	281
Appendix K - Previous RAIB recommendations and responses	283
Appendix L - Previous occurrences	287
Appendix M - Bridge 328	289
Appendix N - Drainage design	292
Appendix P - Railway standards	294



## Introduction

- 1 Metric units are used in this report, except when it is normal railway practice to give speeds and locations in imperial units. Where appropriate the equivalent metric value is also given.
- 2 The report contains abbreviations and technical terms (shown in *italics* the first time they appear in the report). These are explained in appendices A and B. Sources of evidence used in the investigation are included in appendix C. Details of railway standards referenced in this report are included in appendix P.
- 3 At the accident site, the 'down' line carries northbound trains travelling towards Aberdeen and the 'up' line is used by southbound trains travelling towards Dundee and Perth. Positions on the railway are described as the distance from Carlisle, via Perth and a now-closed route through Forfar. Some positions are given using *chains*, each of which is 22 yards or approximately 20 metres, giving 80 chains in one mile. Left and right relate to facing forward on the train being described.
- 4 Minor inconsistencies in the time clocks used by various data sources have been dealt with by recalibrating to British Summer Time (BST). Where rounding is appropriate, times recorded to the nearest second are rounded down to the nearest minute.

## The accident

### Summary of the accident

- 5 At around 09:37 hrs on Wednesday 12 August 2020, a passenger train collided with debris washed from a drain onto the track near Carmont, Aberdeenshire, following heavy rainfall (figure 1). The train (*train reporting number* 1T08) was the 06:38 hrs service from Aberdeen to Glasgow which was returning towards Aberdeen because the line to the south was blocked by a landslide.
- 6 The collision caused the train to derail and deviate to the left, before striking a bridge *parapet* which caused the vehicles to scatter. Three people died as a result of the accident: the driver, the *conductor* and a passenger. The other six people on the train were injured. There was catastrophic damage to the train, and significant damage to railway infrastructure (figure 2).

### Context

#### Location

- 7 The accident occurred close to milepost 221 on the railway between Montrose and Aberdeen. The two-track railway between Laurencekirk (210 miles 44 chains) and Stonehaven (224 miles 74 chains) was opened in 1849 by the Aberdeen Railway Company. From Carmont signal box (which is located near the settlement of Newmill, at 219 miles 39 chains), the railway runs east-north-east on a curving alignment to follow the Carron Water valley towards the coast at Stonehaven (figure 1).

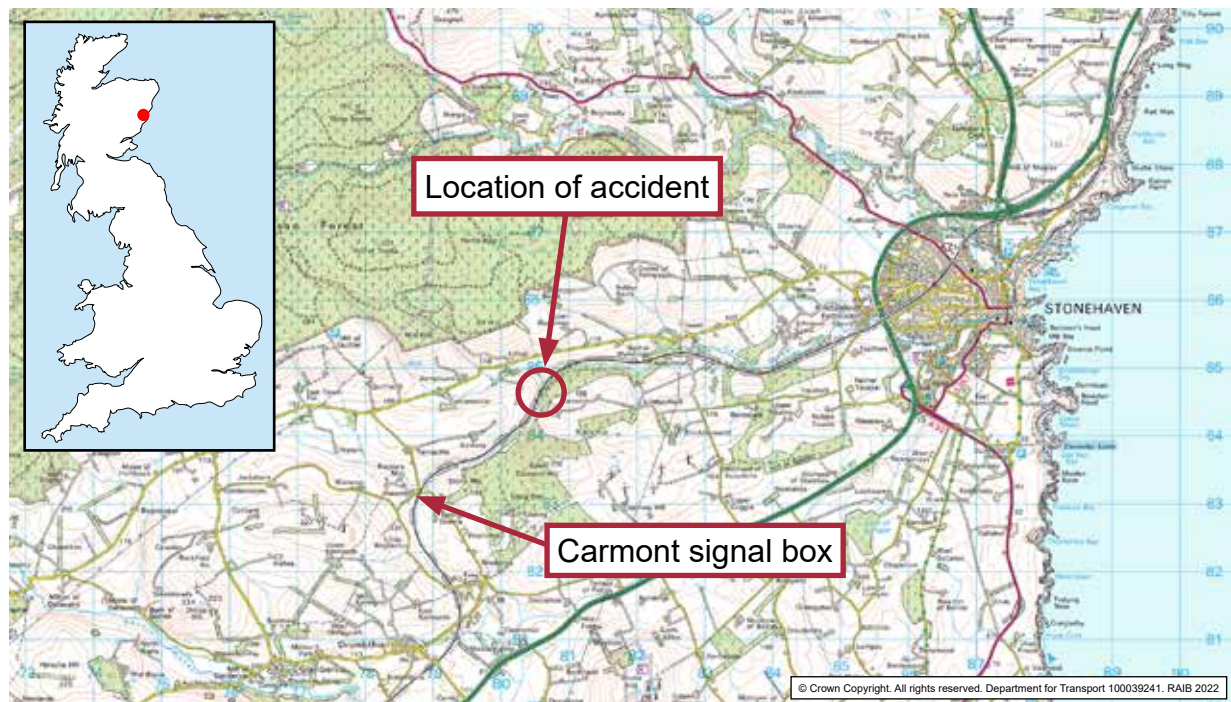

Figure 1: Extract from Ordnance Survey map showing location of accident



Figure 2: The aftermath of the accident (image taken on 13 August 2020)

- 8 About 2.4 km (1.5 miles) north-east of Carmont signal box, the railway is carried over Carron Water on bridge 325. Approaching this bridge from the south, the line runs along the west side of the river valley before entering a left-hand curve of 700 metres radius. This is followed immediately by a right-hand curve which begins about 100 metres before the bridge and becomes progressively tighter until it reaches a radius of about 700 metres a short distance beyond the bridge (figure 3).
- 9 Just beyond the start of the left-hand curve and 570 metres before the bridge, the railway enters a deep cutting with steep rock faces on both sides of the track. The slope on the left-hand side of the railway is up to 21 metres high adjacent to the down line on which the train was travelling. The cutting was excavated through the soil (glacial till) and the underlying rock (Carron sandstone). Beyond the top of the cutting, the ground to the west rises away from the railway. The cutting ends about 50 metres before the bridge, close to the position at which the train derailed on washout debris (figure 4). The railway then runs onto an embankment which starts about 20 metres before the bridge and continues beyond it.

### Organisations involved

- 10 Network Rail owns, operates and maintains the railway infrastructure described in this report and employed the signallers at Carmont, Stonehaven and Laurencekirk signal boxes and also some of the control room staff.
- 11 Abellio ScotRail Ltd, trading as ScotRail, operated the train involved in the accident. It also employed some control room staff and the staff who were on board at the time of the accident. It had held the franchise for most passenger services in Scotland since 1 April 2015.

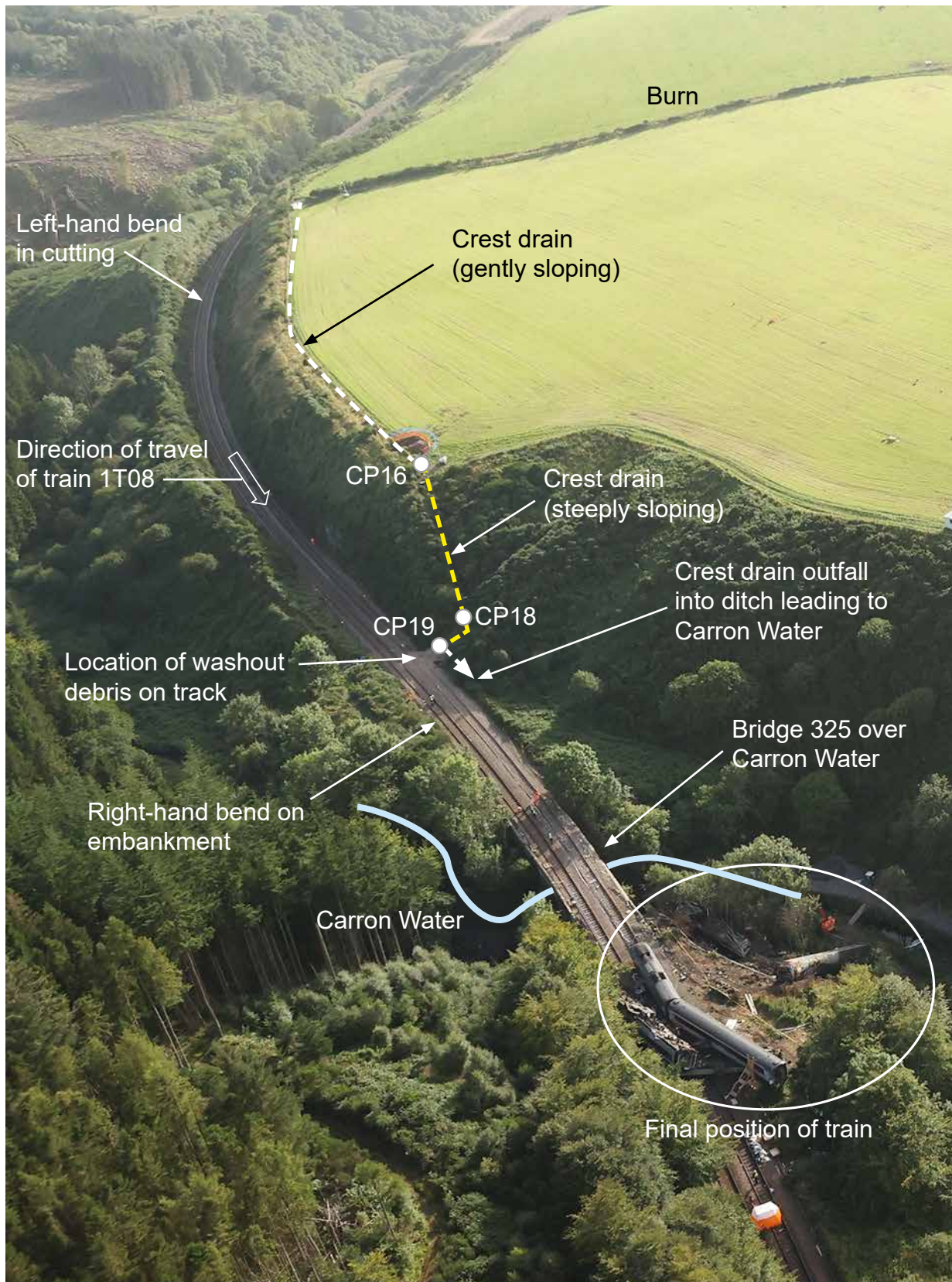

Figure 3: Aerial image of the site (Network Rail)



Figure 4: Washout debris on the track

- 12 Angel Trains Ltd (Angel), a rolling stock leasing company, leased the vehicles of train 1T08 to ScotRail.
- 13 Wabtec Rail Ltd (Wabtec), a rolling stock overhauler and maintainer, had recently overhauled and modified the train involved, and other similar trains, to specifications prepared by ScotRail and Angel.
- 14 Carillion Construction Ltd (Carillion) was a civil engineering contractor and carried out a number of projects for Network Rail under a framework contract. It was commissioned by Network Rail Infrastructure Projects in 2009 to design and construct cutting slope remedial works, including a drainage system, for the deep cutting adjacent to the accident site (referred to as the Carmont project in this report). Carillion went into compulsory liquidation in January 2018. The Liquidator and Special Managers appointed at liquidation have made available relevant electronic and paper records. However, the absence of an ongoing corporate structure means that staff who would normally assist evidence recovery were no longer available and this has possibly affected recovery of some evidence.
- 15 Ove Arup & Partners Scotland Ltd (Arup) is an engineering design organisation which was commissioned by Carillion in January 2010 to design works intended to both protect the railway from rock falls and to provide associated drainage.
- 16 Story Contracting Ltd (Story) is a civil engineering contractor which was undertaking *scour* protection works adjacent to the foundations of bridge 325 on 11 August 2020.
- 17 Amey OWR Ltd (Amey) employed staff who undertook planned inspections of earthworks and structures on behalf of Network Rail.
- 18 All these organisations (the Liquidator and Special Managers in respect of Carillion) freely co-operated with the investigation. Other organisations which assisted with the RAIB investigation are listed in appendix C.

## Trains involved

- 19 Train 1T08 was a high speed train (HST) set and comprised four mark 3 passenger coaches with a class 43 *diesel-electric* power car at each end. These vehicles were originally constructed by British Rail Engineering Ltd and entered service between 1976 and 1980 (figure 5). HSTs pre-date a number of modern standards relevant to crashworthiness but are still authorised to operate on the UK's mainline network. The passenger coaches were among those modified between September 2017 and November 2021 by Wabtec at its workshops in Doncaster and Kilmarnock, to support use of the trains by ScotRail and to achieve compliance with legislation covering accessibility for persons with reduced mobility. This work included fitting powered sliding doors to replace the manually operated 'slam' doors which the vehicles had been built with. The set was released from Wabtec on 8 April 2020.



Figure 5: A typical ScotRail HST with power cars and mark 3 coaches (ScotRail)

- 20 The train comprised the following vehicles, listed from the front of the train at the time of the accident. The lettered designations are used for passenger information and seat reservation purposes and, as these are not altered when the train changes direction, a 'reverse' letter sequence is a normal condition:
- leading power car, number 43140
  - mark 3 coach D, number 42145
  - mark 3 coach C, number 42564
  - mark 3 coach B, number 42007
  - mark 3 coach A, number 40622
  - trailing power car, number 43030.
- 21 Other trains involved in events preceding the accident comprised other HST sets and *diesel multiple units* of classes 158 and 170 (figure 6).



Figure 6: Typical class 158 and class 170 trains (left image Craig Wallace, used under Creative Commons Licence; right image Cal Smith, used under Creative Commons Licence)

### Railway infrastructure

22 The railway is operated on the *absolute block* signalling system, using a mixture of *semaphore signals* and *colour-light signals* controlled locally by signallers located in signal boxes at Laurencekirk, Carmont and Stonehaven (figure 7). At these three locations, and at Newtonhill (the site of a former signal box), there are *crossovers* which enable trains to move between the up and the down lines. The crossover at Carmont is located immediately south of the signal box.

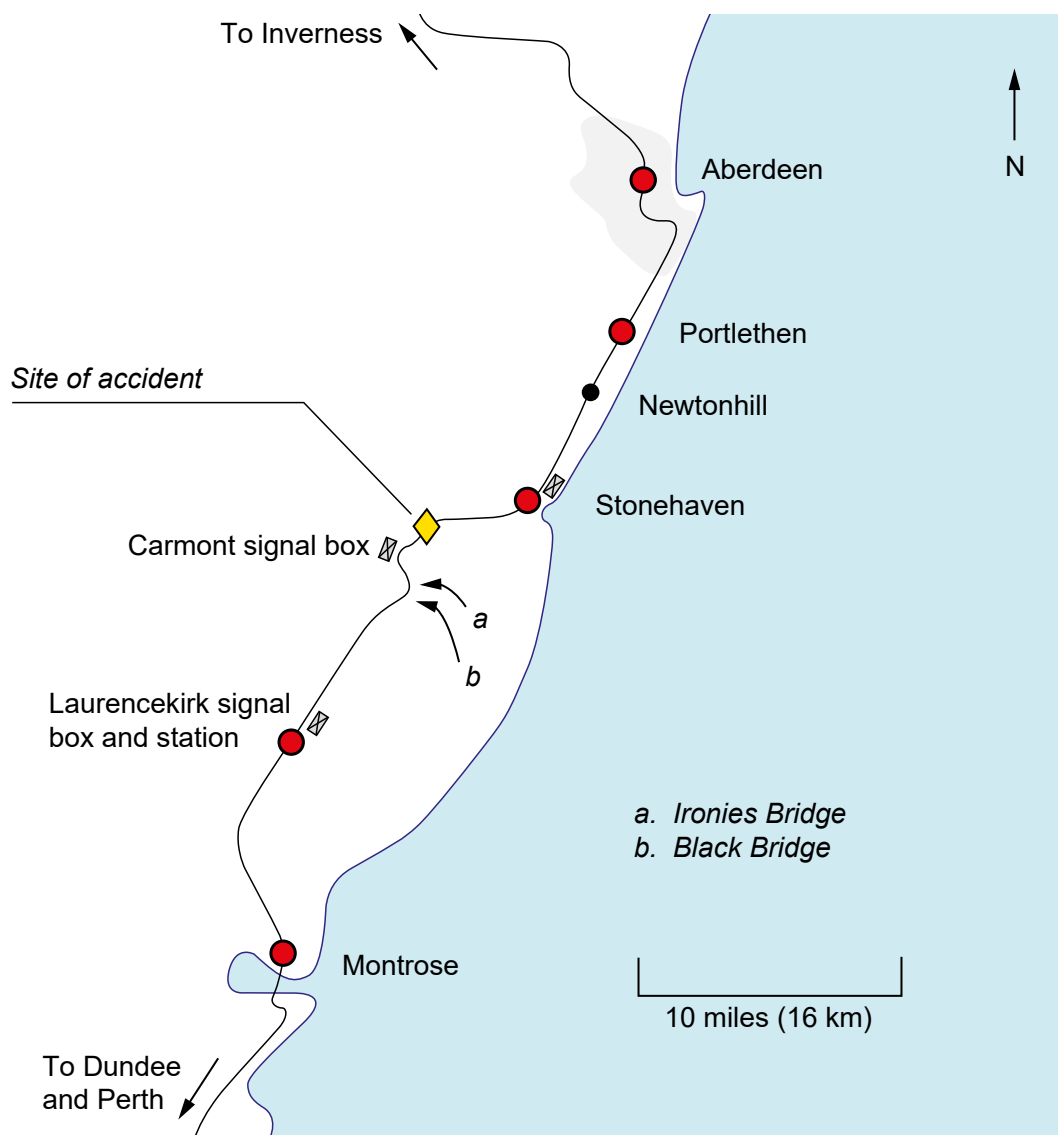

Figure 7: Railway context

- 23 Overall management of train services throughout Scotland's Railway is provided from Scotland's *route control* room (route control), located at the West of Scotland Signalling Centre in Cowlairs, Glasgow. This is an integrated control arrangement staffed by both Network Rail and ScotRail employees (see paragraph 192), and is responsible for providing operational control for all trains operating on Network Rail infrastructure in Scotland, with ultimate control resting with Network Rail. Although some signalling functions are located in this building, signals in the area of the accident are operated from local signal boxes (paragraph 22).
- 24 There is evidence of previous landslips or rock falls affecting the railway cuttings between Carmont and Stonehaven. Network Rail expressed the view that the extent of instability was not unusual in earthworks of this age and type. A landslip in 1915 caused a train to derail at a location a short distance south of the accident site.<sup>1</sup> Deterioration of the 474 metre long cutting slope on the west (left-hand) side of the railway (cutting ECN5/YD051 between 220 miles 1089 yards and 220 miles 1607 yards), including a landslip which blocked both lines on 21 August 2008, resulted in Network Rail instructing Carillion in 2009 to commence planning improvement works. Arup was commissioned by Carillion to prepare a design for these works which, in addition to restraining rock falls on both sides of the railway with rockfall netting, included a new drain running along the top of the west side of the cutting that was intended to intercept water flowing over the surface and through the ground. The new drain was necessary because an old crest drain, which connected into the track drainage, was not functioning effectively. The historical drainage is described in appendix G.
- 25 In December 2010, following advance work to remove vegetation from the cutting slope, Network Rail instructed Carillion to construct these works. The new drain, designated the 2011/12 drain in this report, was installed in two phases, the first in 2011 and the second in 2012. Excepting a short length near *catchpit* 19 (CP19) (see paragraph 94), it comprised a 450 millimetre (18 inch) diameter perforated pipe buried in a gravel-filled trench, an arrangement often known as a *filter drain* or 'french drain' (figures 8 and 9). The gravel was specified by the drain designer as comprising predominantly particles between 20 mm and 40 mm in size, with none larger than 75 mm.<sup>2</sup> The specification required no more than 5% (by weight) smaller than 10 mm, but post-accident investigation found a greater proportion (10% in a sample recovered by RAIB) in this size range (see paragraph 148).
- 26 The drain ran northwards from the highest part of the cutting crest for a total distance of about 372 metres to its outlet (figures 3 and 10). The pipe started near an inlet which captured water from a small burn (stream) which runs along a hedge line towards the railway. The drain sloped gently for 306 metres as it ran along the edge of a field which rose away from the top of the railway cutting. However, as the cutting depth began to reduce, the drain followed the crest and sloped relatively steeply for 53 metres (at an average slope of about 1 in 3) to track level. The final section, about 13 metres long, ran parallel to the track to the outlet into an open ditch running alongside the railway to reach Carron Water downstream of bridge 325.

<sup>1</sup> Evening Express Saturday December 11, 1915 <https://www.railwaysarchive.co.uk/docsummary.php?docID=7811>.

<sup>2</sup> Particle size is measured using sieves with square openings, the reported dimension is the length of the side opening through which a particle passes.





Figure 8: Gravel-filled drain close to washed out areas as exposed during post-accident excavations

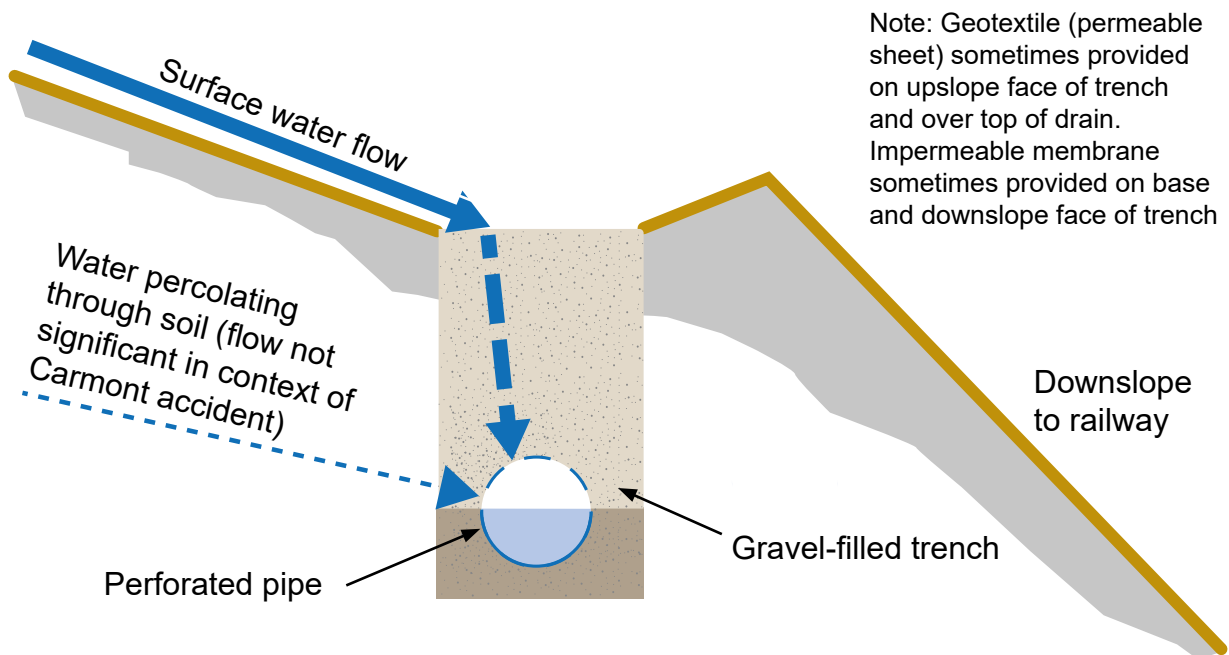

Figure 9: Gravel-filled drain diagram showing water flows (a more detailed diagram is shown in Figure 49)

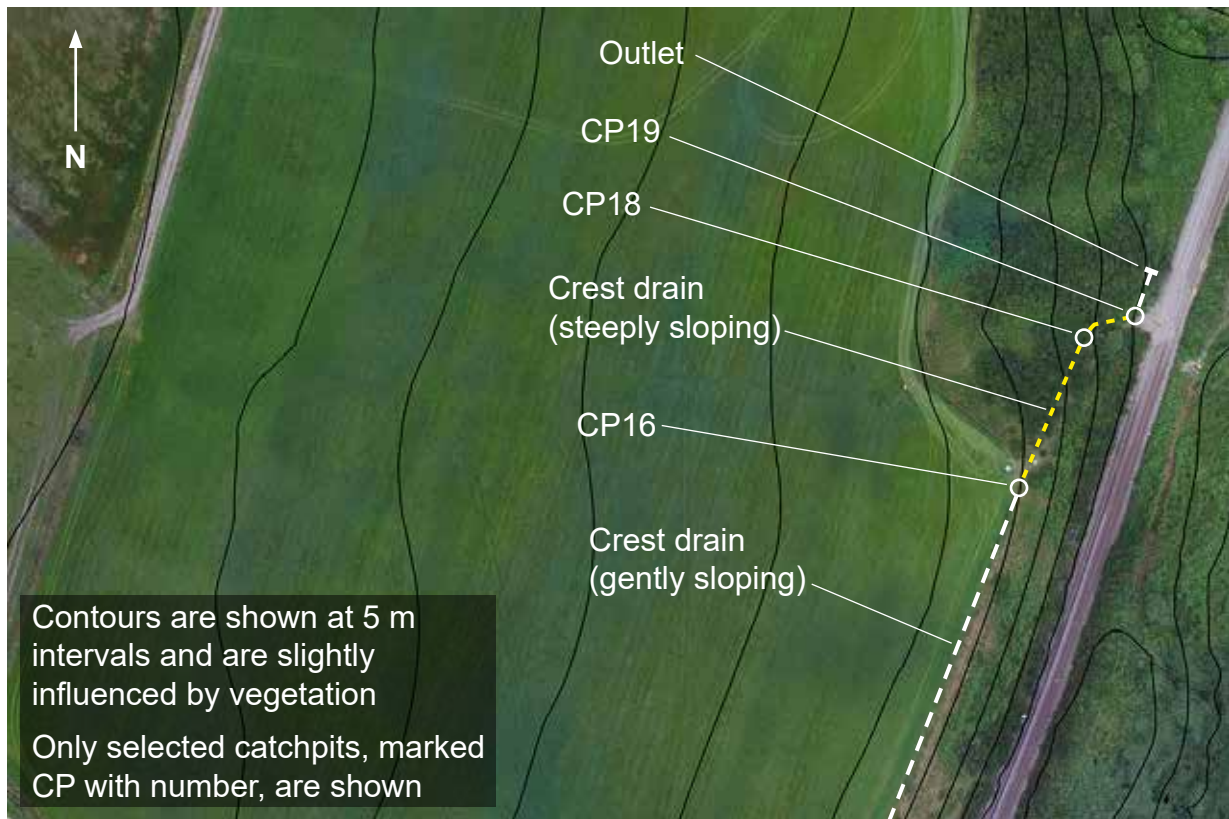

Figure 10: Drainage overview

- 27 Catchpits (access chambers, sometimes called manholes) were provided at intervals along the pipe to allow inspection and maintenance of the pipe. Catchpit 16 (CP16) was positioned at the top of the steeply sloping section of drain and CP18 was located about 41 metres downslope of this (CP17 was not constructed). Shortly after CP18, the pipe changed direction and continued for a distance of 12 metres to CP19 located about 4.8 metres from the railway. Beyond CP19, the drain ran parallel to both the railway and an existing clay pipe track drainage system, which included a catchpit. Both discharged into the same open ditch but the pipework of the 2011/12 crest drain and the track drain were not connected.
- 28 Bridge 325 is a single-span masonry arch bridge which carries the railway 12 metres above Carron Water at 220 miles 1712 yards. At the base of the bridge, scour protection works were in progress at the time of the accident to prevent the river eroding the bridge foundations. This involved work at river level, including installation of a concrete structure on the riverbed. Neither the requirement for this work, nor the way in which it was being implemented, are factors in the accident.

### Staff involved

- 29 The driver of train 1T08 had joined ScotRail as a trainee driver in December 2013. He was certified as competent to drive HSTs in February 2020.
- 30 The conductor of train 1T08 had been employed on the railway at Aberdeen for 37 years, as a driver until 2005 and then as a conductor. In September 2018, he was certified as competent to be a conductor on HSTs modified as described in paragraph 19.

- 31 Another conductor was travelling to Dundee as a passenger on train 1T08 after the train for which she was due to have been conductor was cancelled at Aberdeen (see paragraph 45). She had joined ScotRail as a conductor in January 2018 and was certified as competent on modified HSTs in September 2018.
- 32 The signaller at Carmont at the time of the accident had worked on the railways for 19 years. For most of that time he had been a signaller in the Aberdeen area, covering four signal boxes including Carmont (paragraph 22). He held all the necessary competency certifications required for his role.
- 33 The night shift route control manager (RCM - see paragraph 193) was on duty in route control from 20:45 hrs on 11 August until 06:00 hrs on 12 August. He had worked in the railway industry since 1990, and in his current role since October 2016. He held all the necessary competency certifications required for this role.
- 34 The day shift RCM was on duty from 06:00 hrs on 12 August until after the accident. He had worked in the railway industry since 1981, and in his current role since 2008. He held all the necessary competency certifications required for this role.
- 35 The day shift ScotRail duty operations manager (DOM - see paragraph 194) was on duty in route control on 12 August. He had worked in route control for more than six years, normally as a train service delivery manager, the next tier down from a DOM. However, he regularly worked the higher-grade duty and held all the competency certifications required for this role.
- 36 The Network Rail infrastructure technician who undertook an inspection of the track between Carmont level crossing and Stonehaven on 11/12 August was based at Montrose and had five years' experience. His competencies included track patrolling and track geometry inspection.
- 37 The route asset manager (geotechnics, drainage and off-track), designated RAM (geotechnics) in this report, held the mandatory qualifications and certifications required for this role and was a chartered civil engineer. He had worked in the rail industry since 2002 and in his current role since July 2014.
- 38 Network Rail staff project managing the Carmont project between 2010 and 2012 included:
- The project manager who had over 15 years' experience in the construction and railway industries and had worked for Network Rail since 2006. He had a degree in civil engineering and had completed Network Rail training courses relevant to his role.
  - The construction manager who had over 25 years' experience working on railway projects and had been in a similar role since 2008. He had completed CITB (Construction Industry Training Board) and site manager training courses.

- 39 Carillion staff involved in the Carmont project included the following:
- The site agent (manager) involved with the Carmont project from 2009 until mid-2012 was experienced in the site agent role, had a degree in civil engineering and was a chartered civil engineer. He had worked in the civil engineering industry since 2003.
  - The site engineer who worked on the drainage elements of the Carmont project in 2011 was also involved in planning, but not construction, of the drainage work done in autumn 2012. He had joined Carillion in 2008 and held a degree in civil engineering.
  - The site engineer who supervised the drainage elements of the Carmont project on a visiting basis after work restarted in October 2012 held a degree in structural engineering and had joined Carillion in 2009.
  - The site foreman who worked on the drainage elements of the Carmont project from 2010 until completion in late 2012 had worked on rail projects since 2003 and had joined Carillion in 2006.
- 40 Arup staff involved in the Carmont project included the following:
- A geotechnical engineer with a master's degree in soil mechanics and over 10 years' experience in this role who undertook both geotechnical design work and the role of lead designer.
  - A drainage engineer with a Master of Science degree in engineering and five years' experience in this role.
  - An experienced design manager who led the design team and was a chartered civil engineer with a degree in applied geology.

### External circumstances

- 41 On 11 August 2020, the day before the accident, bands of heavy, locally intense rainfall moved northwards across southern Scotland, the central belt and the Grampian Mountains. Similar bands then developed and moved northwards across the Grampian Mountains, but with little rain in eastern coastal areas between Dundee and Aberdeen. By late in the evening, heavy rain was falling on the eastern part of the central belt and parts of the Grampian Mountains. Carmont remained dry all day, except for light rainfall totalling 0.5 mm (figure 11).
- 42 Large amounts of locally intense rain continued to fall in the central belt and parts of the Grampian Mountains during the early hours of 12 August. Around 05:00 hrs this rain began to extend eastwards to coastal areas around Dundee and then moved northwards up the coast, reaching Carmont at about 05:50 hrs (figure 12). There was then near-continuous heavy rain at this location until around 09:00 hrs. However, it was dry and sunny with broken cloud by the time train 1T08 approached the accident site just before 09:37 hrs.
- 43 The 51.5 mm of rain which fell in this period at the accident site is almost 90% of the average rainfall for August (57.6 mm) at Inverbervie,<sup>3</sup> the nearest location, approximately 13.7 km (8.5 miles) from the accident site, for which long-term data is available. The rainfall also affected neighbouring areas, in which it caused significant flooding (figure 13).

<sup>3</sup> Almost 90% compared to 1901-2010 rainfall, almost 80% compared to 1991-2020 rainfall. <https://www.metoffice.gov.uk/research/climate/maps-and-data/uk-climate-averages/gfn7kmx6u>.

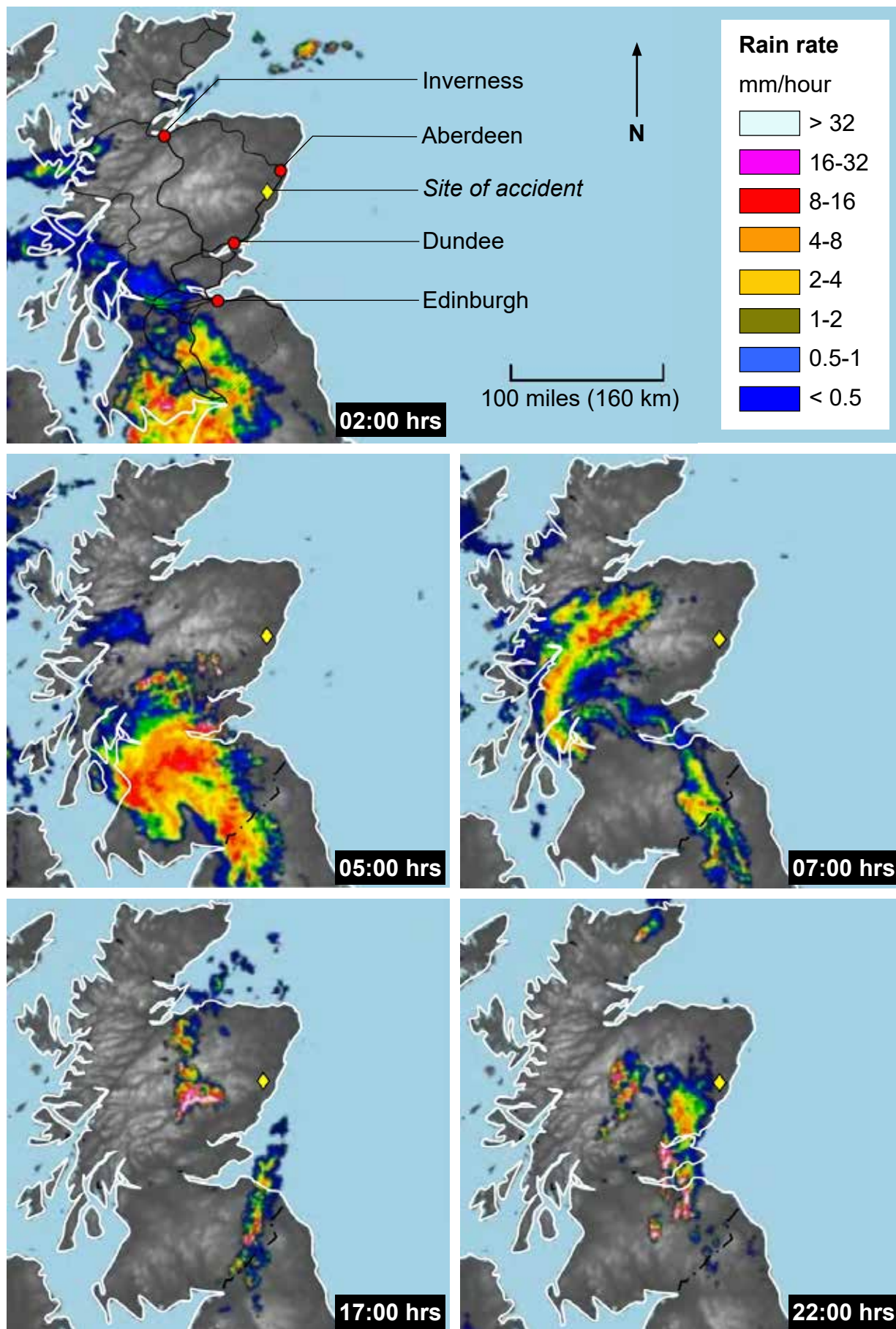

Figure 11: Rainfall - Scotland, 11 August 2020 (Met Office)

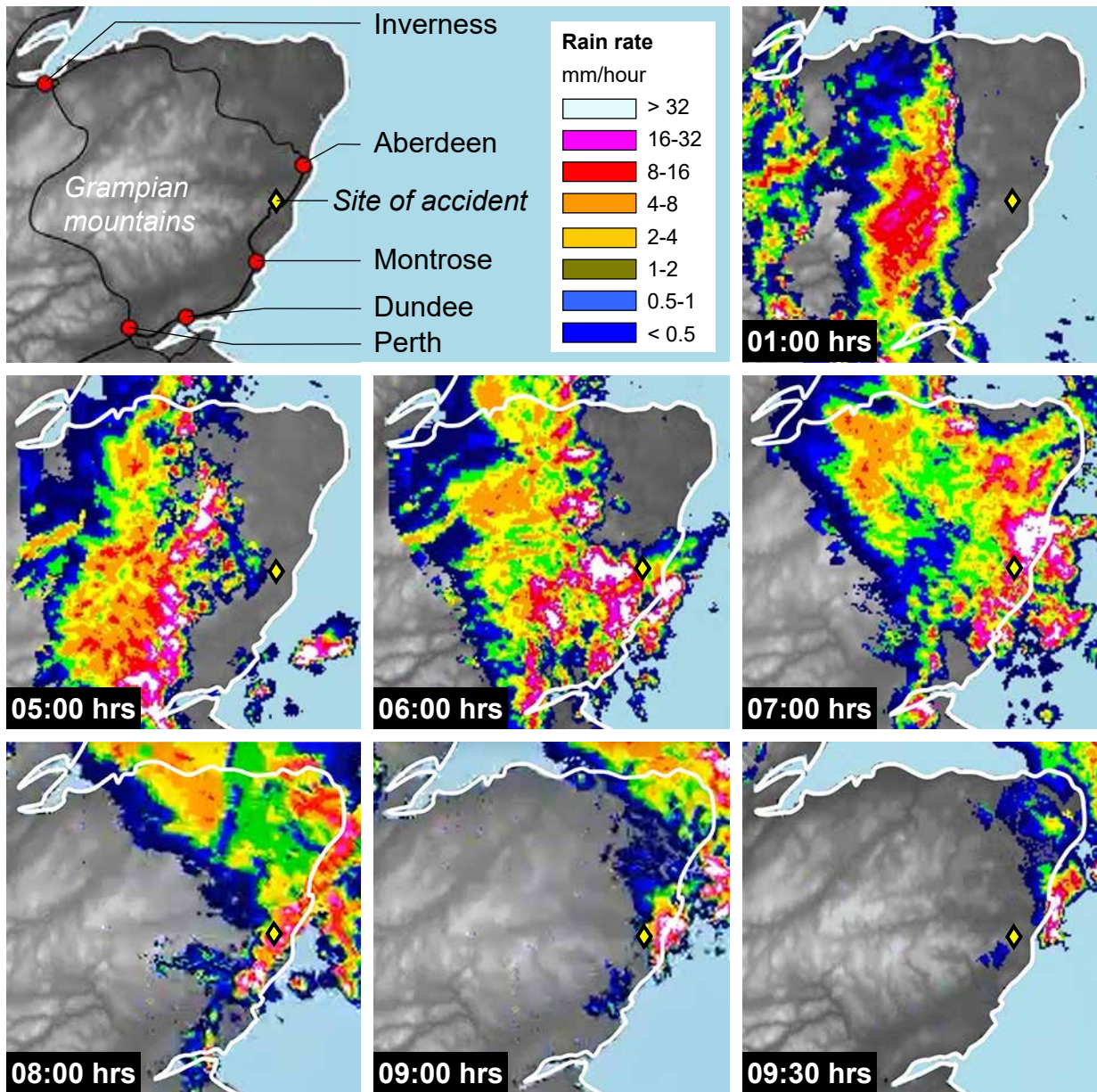

Figure 12: Rainfall - Perthshire, Aberdeenshire and surroundings, 12 August 2020 (Met Office)



*Figure 13: Conditions on a road near Carmont at 08:39 hrs on 12 August 2020 (Chris Harvey)*

## The sequence of events

### Events preceding the accident

- 44 The heavy rainfall on the night of 11/12 August caused considerable damage to the railway infrastructure in Scotland such that, by 06:55 hrs on the morning of 12 August, the only major route in the central and eastern parts of the country which remained unaffected was Inverness – Aberdeen – Dundee. The area south of Perth was affected by multiple instances of flooding, landslips and signal failures (figure 14 and appendix D). In a separate incident, a canal had burst its banks and closed the main Edinburgh to Glasgow line at Polmont.
- 45 On the morning of 12 August, the first two southbound departures from Aberdeen, at 05:06 hrs and 05:36 hrs, left on time and passed through the Carmont area without incident; these were trains 2B12 and 1T06. Train 2B12 ran as scheduled to Montrose. Train 1T06, redesignated as 5T06 as it ran without carrying passengers (see paragraph 567), ran to Dundee where, due to the weather-related disruption, the service was terminated as planned rather than continuing to Glasgow Queen Street, its normal destination. The 05:47 hrs train from Aberdeen to Edinburgh, train 1B07, was cancelled with railway records showing that this was because of '*heavy rain flooding the railway*'. The next departure from Aberdeen was train 2B14, the 06:19 hrs service to Montrose, which ran normally to its destination.
- 46 The train involved in the accident, train 1T08, was the 06:38 hrs service timetabled to run from Aberdeen to Glasgow Queen Street. Because of the weather-related problems south of Dundee, the train was expected to terminate at Dundee on the day of the accident. Train 1T08 departed from Aberdeen on time. It passed Newtonhill at 06:48 hrs where floodwater had begun to reach the railway. Forward and rearward facing closed-circuit television (CCTV) images from the train show flood water covering the sleepers, but the images are not sufficiently clear to show whether water had reached the underside of the *railhead* (about 115 mm above the sleeper), the level at which the railway Rule Book requires drivers to report flooding to the signaller. Neither the Rule Book nor ScotRail's procedures require drivers to report flooding to controllers if it is below the underside of the railhead.
- 47 Train 1T08 called at Stonehaven at 06:53 hrs and had passed Carmont signal box at 07:00 hrs when it was stopped by a railway emergency call made by the Carmont signaller, using the *Global System for Mobile Communications – Railway* (GSM-R) radio system, in response to a report of a landslip (see paragraph 49). The train stopped about 570 metres before the landslip, which was just north of Ironies Bridge, and subsequently returned northwards (see paragraph 57). Because railway emergency calls are relayed to route control, the signaller's call also informed the route control staff about the Ironies Bridge landslip.



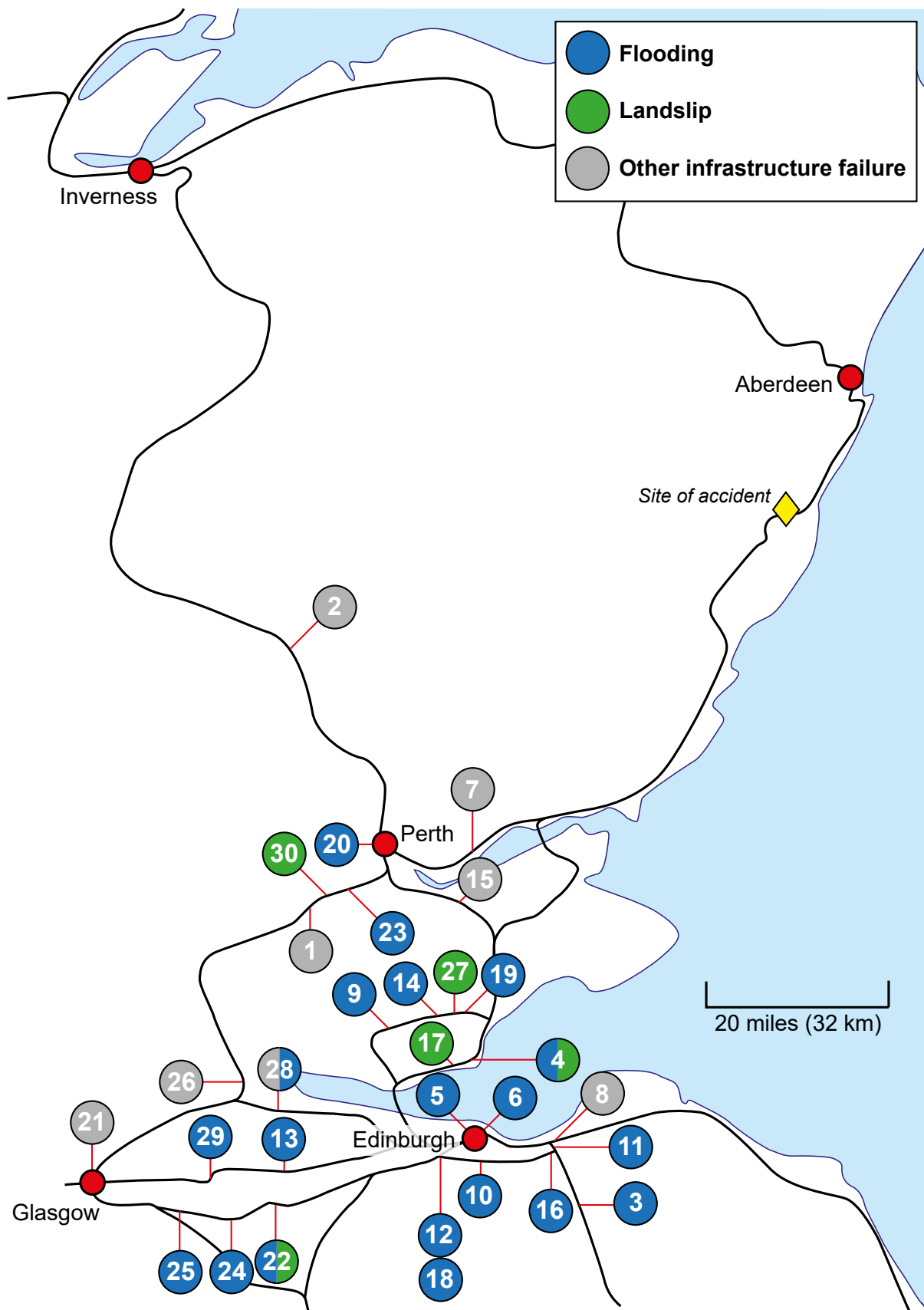

Figure 14: Known infrastructure failures at 06:55 hrs on 12 August 2020. Reference numbers relate to incident details given in appendix D. Incidents in the area around Carmont reported after 06:55 hrs but before 09:00 hrs are shown in figure 16.

- 48 The first northbound train of the day to pass the accident site was train 1H25, the 05:39 hrs service from Dundee to Inverness (via Aberdeen). This train passed Carmont on time at 06:46 hrs and then ran through floodwater at Newtonhill, about 9 km (5.6 miles) north of Stonehaven and 18 km (11.2 miles) north of Carmont. At 06:57 hrs, the driver made a railway emergency call using the GSM-R radio system to inform the Aberdeen signaller about the floodwater. This call was also relayed to route control. The railway was then closed at Newtonhill until the situation could be assessed by Network Rail staff on the ground. Train 1H25 then continued on its journey towards Aberdeen.
- 49 The next northbound train to pass the site was train 2B13, the 06:39 hrs service from Montrose to Inverurie (via Aberdeen). At 07:00 hrs, this train, travelling on the down line, stopped adjacent to Carmont signal box. The driver reported to the signaller that he had seen a landslip affecting the up line at a location he identified as Black Bridge, an *underline bridge*, but which was subsequently found to be a short distance away near Ironies Bridge, an *overline bridge*. These locations are respectively 2.1 km (1.3 miles) and 1.6 km (1 mile) south of Carmont signal box. Train 1T08 passed Carmont signal box, heading towards the landslip, while the signaller was at the signal box stairs receiving details of the landslip from the driver of train 2B13. The signaller ran back into the signal box to make a railway emergency call by radio to inform the driver of train 1T08 about this landslip (paragraph 47).
- 50 After the driver of train 2B13 had reported the landslip to the Carmont signaller, train 2B13 resumed its journey towards Aberdeen and passed the accident site at about 07:07 hrs, before reaching Stonehaven station at 07:13 hrs. It was unable to continue any further because of the flooding which had closed the railway at Newtonhill (paragraph 48). The driver of 2B13 later stated that he had seen nothing unusual between Carmont and Stonehaven.
- 51 A Network Rail staff member arrived at Black Bridge, and the signaller provided him with protection from train movements, at 08:19 hrs. The staff member went to investigate the landslip which had been reported by train 2B13. He was unable to locate a problem at Black Bridge and started to walk north. He found the landslip blocking the up line approximately 600 metres away, close to Ironies Bridge (figure 15). From this location, he could see train 1T08 stationary further north on the up line. He also found flooding affecting the down line in the vicinity of Ironies Bridge, and reported this to the Laurencekirk signaller, who informed route control at 08:50 hrs (see paragraph 53).
- 52 To the south of Ironies Bridge, train 1A43, the 06:00 hrs service from Perth to Inverurie, had been held at Laurencekirk station because of the flooding at Newtonhill. This was to avoid the risk of stranding the train, and its passengers, in a remote location because the next station, Stonehaven, was occupied by train 2B13 (paragraph 50). At 08:28 hrs, the driver of train 1A43 was advised by route control, via the signaller at Laurencekirk, that because of the route blockages further north, the train was to be terminated at Laurencekirk. The train was redesignated as 1Z43, crossed to the up line and departed southwards from Laurencekirk station.

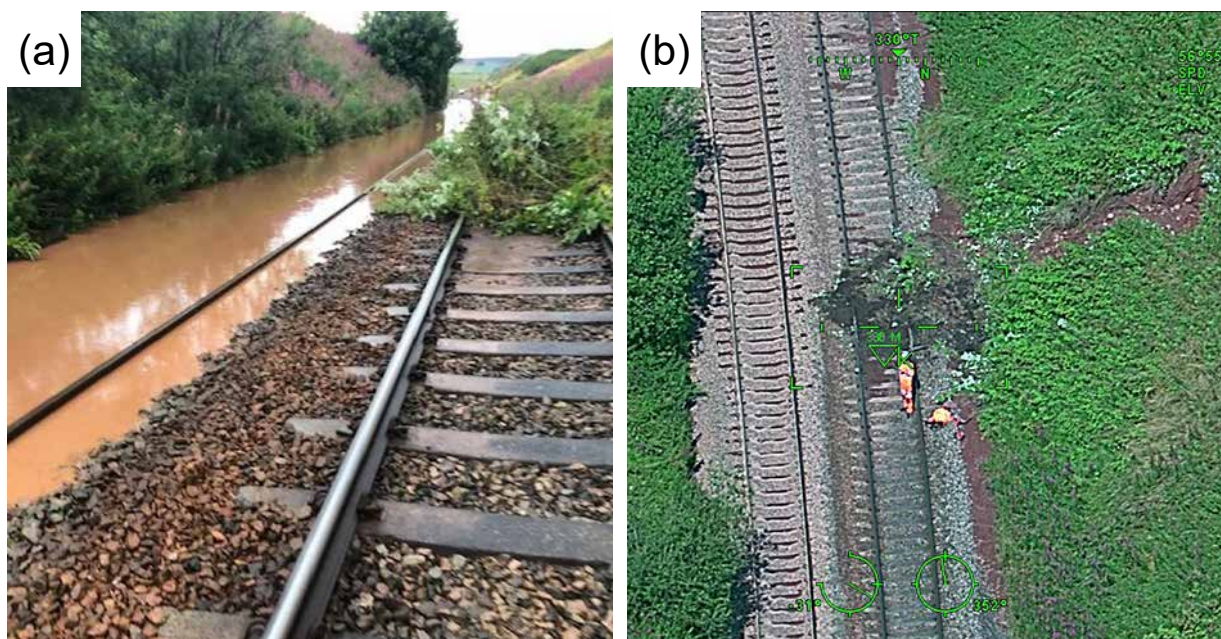

Figure 15: Landslip blocking the up line 1.6 km (1 mile) south of Carmont signal box near Ironies Bridge (a) at around 08:50 hrs on 12 August 2020 when the down line was also flooded, and (b) at around 11:00 hrs on 12 August 2020 after flooding had receded (Network Rail)

- 53 After travelling about 730 metres, the driver of train 1Z43 stopped on seeing a landslip ahead at 210 miles 154 yards. The driver informed the Laurencekirk signaller who passed this information, and information about the flooding at Ironies Bridge (paragraph 51), to route control at 08:50 hrs. This meant that route control staff were now aware of two landslips and two flooding events in the 34 km (21 mile) section of line from just south of Laurencekirk to Newtonhill (figure 16), in addition to the weather-related events elsewhere (paragraph 44, figure 14).
- 54 As train 1T08 was unable to proceed south beyond Ironies Bridge (paragraph 47), and there was concern about the passengers being stranded, a member of route control staff had called the Carmont signaller at 07:18 hrs and asked him to arrange with the signaller at Stonehaven for train 1T08 to return to Stonehaven. This movement involved the train crossing from the up line to the down line over the crossover at Carmont. The *points* at this crossover were not equipped with *facing point locks*, a device required to secure points in position when they are used by passenger trains in the diverging, or facing, direction. For this reason, the railway Rule Book required temporary clamps and *scotches* to be fitted to the points which make up this crossover before 1T08 could return north.

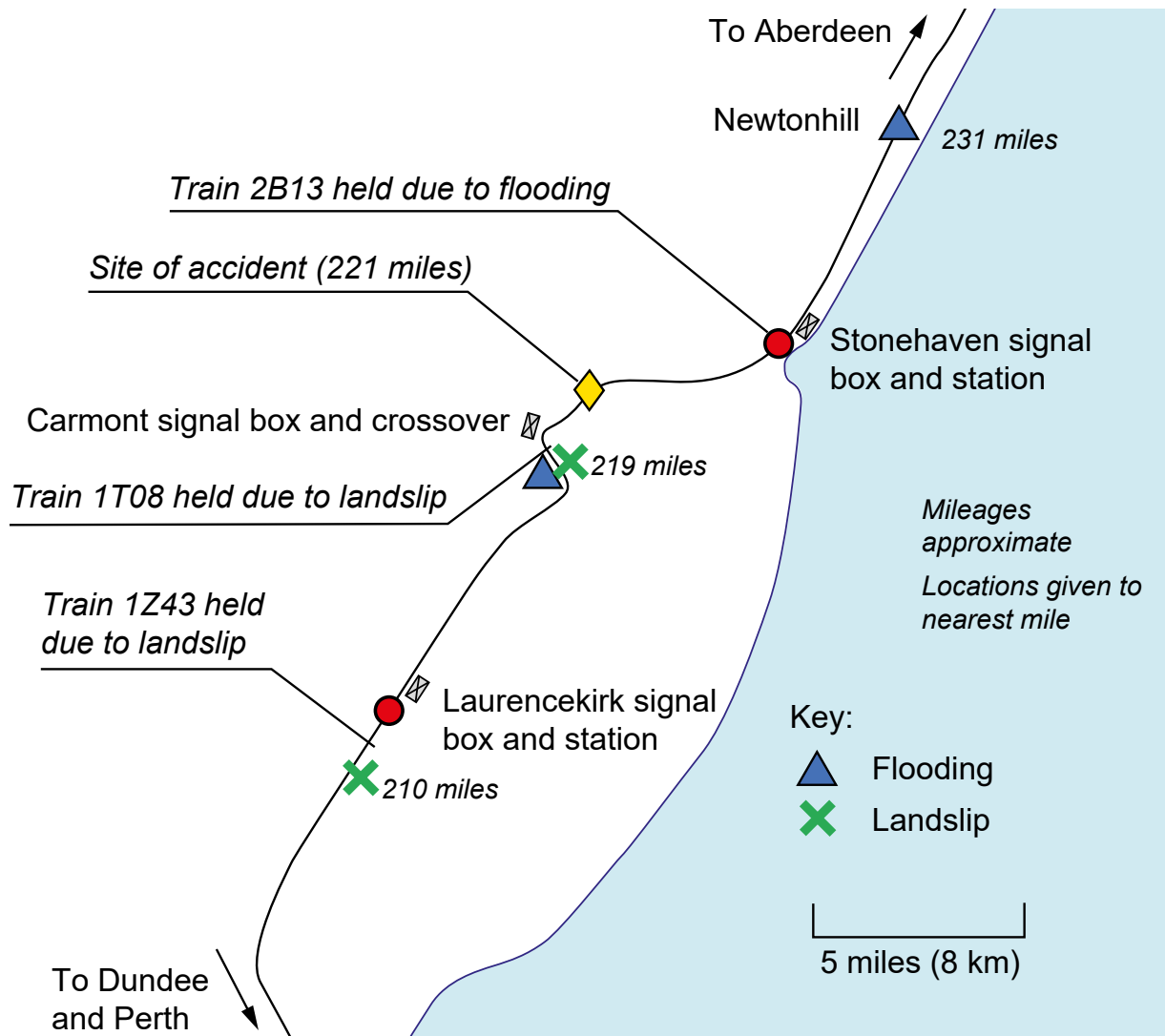

Figure 16: Train positions and known infrastructure failures around Carmont at 09:00 hrs on 12 August 2020

55 There was no requirement for clamps and scotches to be held at Carmont signal box and the signaller was neither trained, nor expected by Network Rail, to apply them (this differs from some historical practice). Therefore, a Network Rail *mobile operations manager* (MOM) was tasked (at 07:40 hrs) to travel to Carmont with the equipment for temporarily securing the crossover to allow the passage of train 1T08. The MOM, who was based in Aberdeen, experienced considerable difficulty in reaching Carmont because of the many flooded roads in the area, and eventually arrived there at approximately 08:55 hrs. Because the MOM was delayed, Network Rail's *local operations manager* (LOM) arranged with another MOM at 08:35 hrs that they would both drive separately to Carmont, in case they could secure the crossover sooner than the original MOM. Witness evidence indicates that the second MOM arrived at Carmont signal box at 09:30 hrs, and the LOM at 09:40 hrs.

- 56 Meanwhile, the passengers on train 2B13 had alighted at Stonehaven, and the train moved forward at 09:08 hrs to clear the platform ready for the arrival of train 1T08. By 09:17 hrs, the necessary clamps and scotches had been fitted to the crossover points at Carmont. At 09:20 hrs, the driver of train 1T08, which was still standing between Carmont signal box and Ironies Bridge, advised the Carmont signaller that he had changed ends and was ready to depart in the down (northward) direction.
- 57 At 09:28 hrs, the signaller used the GSM-R radio system to speak to the driver and authorised him to return north to Stonehaven. Train 1T08 moved off and crossed over to the down line near Carmont signal box. CCTV from the forward and rear facing cameras on the train shows that the rain had stopped, and the sun was shining as it passed Carmont signal box at about 09:34 hrs. The train's speed then increased towards 75 mph (121 km/h), the normal maximum permitted speed at the accident site (see paragraph 256).
- 58 While train 1T08 was stationary to the south of Carmont signal box, witness evidence indicates that the conductor was speaking with passengers and regularly checking on their welfare. At, or shortly after, the time that train 1T08 started to move northwards, he walked through the train and advised the passengers that only the door at the northern end of the leading coach (D) would be opened at Stonehaven; therefore, any passengers who wished to leave the train at this station were asked to move to that coach. After passing this information onto passengers, the conductor stood in the northern (leading) vestibule end of coach D, where he remained until the accident.

## Events during the accident

- 59 In the area of bridge 325, north of Carmont signal box, heavy rain between 05:50 hrs and 09:00 hrs on 12 August washed gravel from the 2011/12 drain (paragraph 25), together with stone and soil eroded from the ground on either side of the drain, onto the track. Most of the gravel was washed out from the drain trench for a distance of approximately 9 metres immediately upslope of CP18 and about 6 metres immediately downslope of this catchpit (figure 17 and figure 18). This, and stones from the surrounding ground, covered the down line between 220 miles 1610 yards and 220 miles 1621 yards (figure 19). The precise time at which this occurred is not known, but must have been between 07:07 hrs, when the last train before the accident passed this location (paragraph 50), and the arrival of train 1T08 at 09:37 hrs. Modelling indicates it was probably between 08:15 hrs and 09:00 hrs (appendix H).

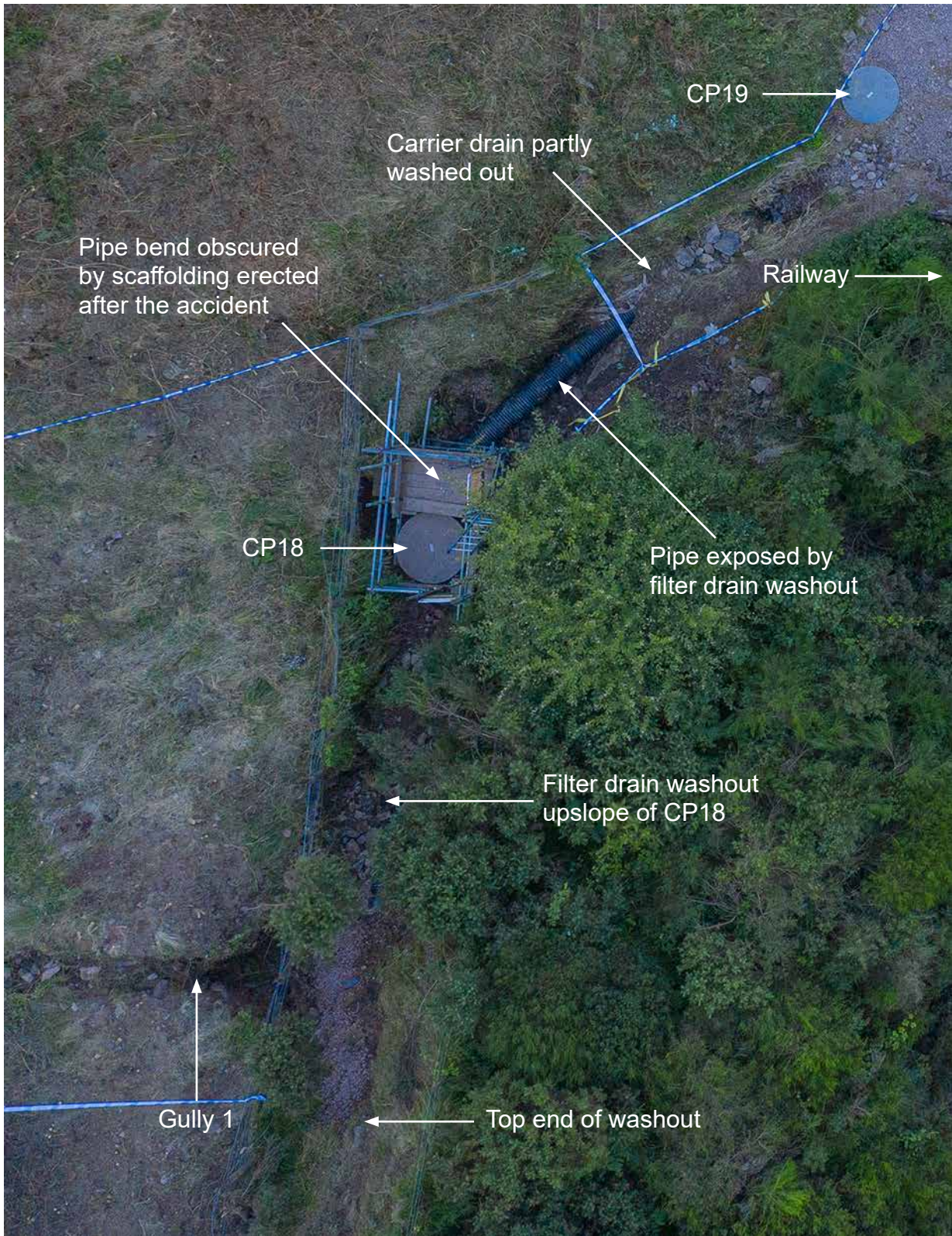

Figure 17: Aerial view of CP18 showing extent of washout



Figure 18: Washout upslope of CP18 (left image) and partial washout downslope of CP18, both images facing towards CP18



Figure 19: Washout debris on the track approximately 55 minutes after the accident. A short length of scrap rail unrelated to the accident is also visible (Story Contracting)

- 60 Data from the *on-train data recorder* (OTDR) fitted to the trailing power car shows train 1T08 travelling at about 73 mph (117 km/h), which was less than the maximum permitted speed of 75 mph (121 km/h), as it approached the washout debris. The left-hand curve on the approach would have obstructed the driver's view of the debris until the train was less than 120 metres from it; the train covered this distance in about three and a half seconds. Although the OTDR records an application of the emergency brake about one second before the train struck the debris, there was insufficient time for this to have had any significant effect on the train's speed. However, the action of applying the emergency brake would have removed traction power from both power cars. When the leading power car struck the debris, it derailed to the left. Its leading end progressively deviated towards the cess as the track curved to the right, and it continued running derailed for about 60 metres until it struck the south end of bridge 325's down-side parapet. After destroying part of the parapet, the power car fell off the bridge and down onto a wooded embankment below, the driver's cab became detached on impact with the ground and the power car caught fire.
- 61 Three of the following five vehicles travelled in different directions beyond the bridge (figure 20). The first passenger coach (D) came to rest on its roof, almost at right angles to the track. The second passenger coach (C) came to rest overturned onto its roof with its trailing end on top of the first coach and facing the direction of travel. The third passenger coach (B) ran down the steep embankment to the left side of the railway, came to rest on its right-hand side and subsequently caught fire. The fourth passenger coach (A) remained upright and came to rest with its leading end on top of the first coach. The trailing power car remained upright on the down line, still coupled to the rear of the fourth coach. Its left-hand wheels were derailed and its right-hand wheels were resting on the right-hand rail which had rolled over to the right. The behaviour of the train in the derailment and the damage it sustained are described in more detail in paragraphs 453 to 469.



Figure 20: Derailed train



## Events following the accident

- 62 The contractor's staff working on the scour protection project at bridge 325 (paragraph 28 and appendix F) had a small team on site on 12 August to protect plant and equipment from rising water levels. Two people were standing by the river when they heard a '*loud rumbling noise from above*' and ran as the derailed vehicles fell down the embankment. The contractor's supervisor made a 999 call to report the accident at 09:37 hrs.
- 63 At 09:43 hrs, after the 999 call had ended, Police Scotland advised Network Rail route control of a report of a train off the track and on fire between Carmont and Stonehaven. This message was passed to the signaller at Stonehaven, who in turn called the Carmont signaller, and at 09:48 hrs the signallers acted to stop any further train movements between these locations.
- 64 The scour protection contractor's staff provided initial assistance to the injured people. They also used a small excavator that was on site to move their portable fuel tank away from the scene and to place a timber mat across the river to make a temporary bridge to access the site. The excavator was later used to put water on the passenger coach fire using its bucket, which was successful until the fire spread beyond the reach of the excavator. Local residents also responded and provided assistance to injured people and the emergency services.
- 65 The Network Rail LOM and MOMs who had been at Carmont signal box to secure the crossover became aware of the accident from the call to the signaller and witness evidence suggests they reached the vicinity of the accident at approximately 09:52 hrs. On their arrival, they were initially unable to communicate with route control due to the poor mobile phone reception and joined the contractor's staff and local residents who were assisting the injured passengers. At about 10.15 hrs, the conductor who had been travelling as a passenger to Dundee on train 1T08 (paragraph 31) phoned Carmont signal box from a lineside telephone, having walked southwards along the line from the site of the accident (see paragraph 582).
- 66 The accident occurred at a location surrounded by agricultural land and woodland, about 1,000 metres along farm tracks from the nearest public road and without a nearby distinctive feature recognisable outside the railway industry. This resulted in some uncertainty among the emergency services about the exact location of the accident and the means of reaching it from public roads. Despite these challenges, the first Police Scotland responders were reported to be at the location by 10:12 hrs and the Scottish Ambulance Service by 10:20 hrs. Scottish Fire and Rescue Service appliances were too large to get close to the accident site and started to arrive on the nearby public road shortly after 10:20 hrs; despite these access problems, the fire service extinguished the fires.
- 67 After the derailment, the emergency services established their presence on site and removed the injured people to hospital.

- 68 ScotRail notified RAIB of the accident at 10:10 hrs on 12 August. RAIB immediately despatched a team of investigators by air and road, the first of whom arrived on site at 18:00 hrs. In conjunction with investigators from the police and the Office of Rail and Road (ORR), RAIB began identifying and collecting evidence. This included an examination and survey of the train wreckage, the track, bridge 325, the washout debris, the drain the debris had come from, other drainage features in the area, and the steep slope and field above the railway. Further RAIB staff were deployed to site during subsequent days.
- 69 Preparations for the recovery and removal of the vehicles began immediately. The need to construct a suitable access road and foundation for cranes to work from meant that it was 7 September before the first of the vehicles of train 1T08 was removed from the site. All the vehicles were taken to a secure, covered location for detailed examination.
- 70 The last vehicle was lifted from the railway on 15 September and the line was formally handed back to Network Rail on 19 September. However, before this date, Network Rail had been able to access parts of the site to plan and begin repairs. The line was reopened for traffic on 3 November, after new drainage had been installed.
- 71 Investigation on the land above the railway, by RAIB and others, continued until April 2021. This included digging trial pits and boreholes to identify soil types and field drains, to undertake on-site measurement of groundwater and soil permeability, and to recover samples of soil and gravel for off-site testing.

## Analysis

### Identification of the immediate cause

#### 72 Train 1T08 derailed because it struck washout debris.

73 Evidence that train 1T08 struck the washout debris, causing it to derail, is provided by:

- CCTV images from the train (figure 21)
- grooves cut through the debris consistent with the passage of the train (figure 22)
- the absence of derailment marks found on the track on approach to the washout
- marks indicating one wheelset had derailed immediately after the washout and the subsequent derailment of further wheelsets
- sleeper damage consistent with impact from several derailed wheelsets between the washout and bridge 325 (appendix F, figure F.1).



Figure 21: CCTV images from train 1T08 showing the washout (ScotRail)



Figure 22: Washout debris covering the track and point of derailment at sleeper 0. Grooves cut by the wheels of train 1T08 through the debris are visible

- 74 The washout debris had covered both running rails of the down line. The depth of material on the left rail was greater than on the right rail. Estimates made by RAIB after the derailment indicate the depth of debris above the left and right rails was likely to have been around 170 mm and 135 mm respectively before the train ran through it. Given the relatively low height of the debris, the derailment is unlikely to have been caused by material accumulating under the bogie frame or cab of the power car.
- 75 The first indications of the point of derailment were faint flange tip marks on the head of the left-hand rail close to the northern limit of the debris (designated sleeper 0 during the post-accident examination of the track) and a *tread corner mark* on the right-hand rail at the same position. These marks and the subsequent anticlockwise *yaw* (rotated) attitude of the leading bogie (see paragraph 77) indicated that it was the leading wheelset that had derailed first. As the leading wheelset had run through the washout debris, its left-hand wheel had been lifted up by debris between the wheel and rail, and displaced to the left, such that its wheel flange was running on the railhead (figure 23).

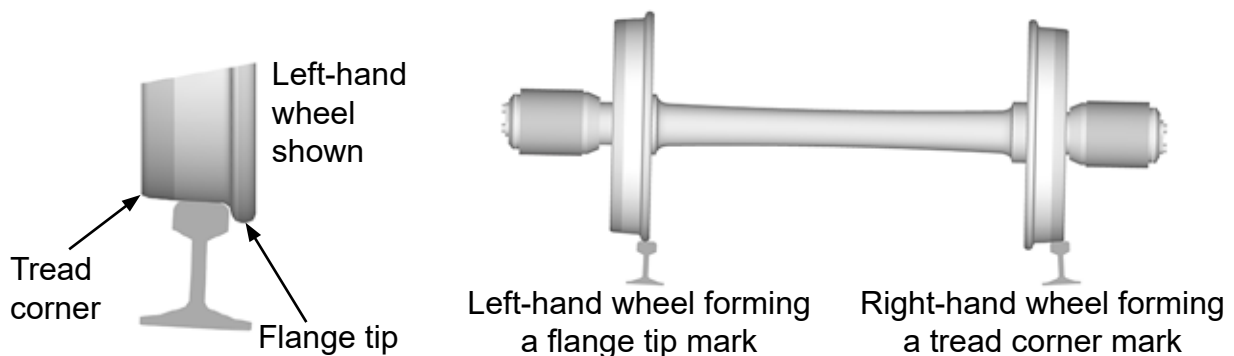

Figure 23: Wheel components and rail marks

- 76 The track was on a slight right-hand curve with a radius of about 1400 metres at the washout location, and the leading bogie should have been running almost straight. The displacement of the left-hand wheel was likely to have been caused by a combination of lateral forces on the wheel due to curving, the effects of running through deeper debris around the left-hand rail than the right-hand rail (tending to yaw the bogie left), and the small effect of rail curvature over the distance that the left-hand wheel flange traversed over the railhead. It is likely the right-hand wheel was also lifted as it ran through the debris. It then dropped into the *four-foot* just as the left-hand flange passed over the left-hand rail and dropped entirely off the rail and into the cess (figure 24a).



Figure 24: Position of leading wheelset (shown by wheelset template) from washout to bridge 325

- 77 Beyond sleeper 0, the leading bogie naturally adopted an anti-clockwise yaw attitude which is likely to have generated sufficient *angle of attack* between the left-hand wheel of the second wheelset and the left rail such that it derailed by *flange climb*. It fell off the rail around 3.5 metres beyond sleeper 0; both axles of the leading bogie were now derailed to the left. There was no evidence that the second wheelset derailed while running over the washout debris.
- 78 Derailment of the leading bogie caused the leading power car to yaw anticlockwise to the left. This in turn led to the left-hand wheels of the trailing bogie developing an angle of attack relative to the left rail. Subsequently the third and fourth wheelsets, those on the trailing bogie, derailed by flange climb, 7.5 metres and 13.3 metres beyond sleeper 0, respectively. The trailing end of the power car is likely to have remained coupled to the leading end of coach D. RAIB found no other derailment marks to suggest that any of the wheelsets on the coaches had derailed until they had passed the start of the bridge.
- 79 Observations of the derailed wheel paths in the ballast, showed the leading power car continued to drift further to the left as it approached the bridge, indicated by the position of the wheelset template (representing the leading wheelset) in figure 24b and 24c. From around sleeper 78 (approximately 55 metres beyond sleeper 0) and before the start of the bridge at sleeper 88 (approximately 61 metres beyond sleeper 0), the right-hand wheels of the leading bogie climbed over the left-hand rail and into the cess. The leading power car deviated even further to the left and subsequently came into collision with the end of the bridge parapet. Damage on the leading bogie indicates that the leading power car struck the bridge parapet slightly to the left of the vehicle centre line, which at that point had deviated between 2.0 and 2.4 metres from the centre line of the track.

- 80 The leading power car struck and began demolishing the left-hand bridge parapet. As a result of the impact forces on the power car, it deviated further to the left of the track, and compressive forces quickly built up at the interface between it and coach D which was still running on the track. The build-up of compression force and vertical height difference at the interface between the vehicles (the derailed trailing end of the power car being lower than coach D), initiated coach D to override the trailing right-hand side of the power car. Near the middle of the bridge, it is likely the combination of excessive pitch and yaw angles that developed as the overriding initiated, caused the coupler of coach D to fail and the leading power car to become detached from coach D. Both vehicle ends suffered substantial structural damage in this interaction. The power car then veered off the side of the bridge at speed and was briefly airborne before landing on the embankment, with its cab end taking the brunt of the impact. The leading bogie of coach D also became detached during the overriding and followed the power car off the bridge and onto the embankment.
- 81 The passenger coaches continued over and beyond the bridge with the leading end of coach D having been pulled to the left as a result of its interaction with the leading power car. The first three coaches then jack-knifed in sequence, each becoming uncoupled from the adjoining vehicles, shedding their bogies and rotating in different directions in the horizontal plane. The motion of the train from the initial derailment at the washout until the vehicles came to rest is detailed in appendix E, together with supporting evidence provided by damage to the vehicles, infrastructure and trees along the right-hand side of the railway.

#### Pre-accident infrastructure condition

- 82 Pre-accident inspections by Network Rail and post-accident surveys by RAIB, detailed in appendix F, did not identify any track faults which could have initiated the derailment. The ballast depth was relatively large as the track approached the bridge on the embankment, and this would have encouraged leftward deviation of the leading bogie. Ballast depths are often relatively large on embankments approaching bridges beneath the railway because embankments generally settle after construction, while bridges normally remain relatively static. Ballast is then added to the embankment to keep the track at the level needed to cross the bridge. Although relatively large, the ballast depth on the approach to bridge 325 was not exceptional for this type of location and there is no evidence that the ballast profile at the end of the sleepers (ballast shoulder) was non-compliant with Network Rail standard NR/L2/TRK/001.<sup>4</sup>
- 83 Bridge 325 was not causal to the initial derailment but the presence of the structure, and the way in which its upper parts were constructed, affected the consequences as explained above. The condition of this structure is reviewed in appendix F, which also explains why scour works in progress when the accident occurred, and defects remedied shortly after the accident, are not relevant to the cause or consequence of the accident.
- 84 Instability of the cutting slope, excluding material washed from the drain and its immediate surroundings, was not a factor in the accident, as demonstrated by the composition of debris deposited on the track (see paragraph 97).

---

<sup>4</sup> NR/L2/TRK/001/Mod03 issue 8, published 3 September 2016; 'Plain line track'.

### Maintenance status of the train

- 85 Following the accident, RAIB examined the maintenance and overhaul records for the two power cars. This showed that the power cars were compliant with the ScotRail maintenance and overhaul plans (document SR/VI4300 issue 1 revision D dated October 2019). No outstanding defects or other maintenance issues relevant to the accident were recorded.
- 86 A similar examination of the maintenance and overhaul records for the four coaches found no outstanding defects or maintenance issues relevant to the accident. With the exception of the deferred 'C6' overhaul on coach D (vehicle number 42145), discussed below, the coaches were fully compliant with their maintenance and overhaul plan (ScotRail document SR/VI1003 issue 1 revision E dated October 2019).
- 87 Coach D was due to receive a 'C6' overhaul in February 2020, but this had been deferred until September 2020. As required by ScotRail's Safety Management System, ScotRail had carried out a risk assessment justifying this deferment. RAIB has carried out a review of the content of the deferred 'C6' overhaul. Such an overhaul would normally encompass works such as inspection and rectification of vehicle corrosion. However, such corrosion works had been carried out when the vehicle was fitted with power-operated sliding doors (paragraph 19). None of the remaining deferred tasks would have had any effect on the cause or the consequences of the accident.

### **Identification of causal factors**

- 88 RAIB's investigation concluded that had the drainage system been installed in accordance with the design, it is highly likely to have safely accommodated the flow of surface water on 12 August 2020. However, as installed, the drainage system was unable to do so (paragraph 91). This occurred because:
- a) The gravel in the drainage trench was vulnerable to washout if large flows of surface water concentrated onto a short length of drain (paragraph 100).
  - b) Carillion did not construct the drain in accordance with the designer's requirements (paragraph 114).
- 89 RAIB also identified the following possible causal factors:
- a) Network Rail's project team were probably unaware that the 2011/12 drain was significantly different from that intended by the designer and therefore did not take action (paragraph 160).
  - b) Network Rail's processes that were intended to ensure a managed transfer of safety-related information from constructor to infrastructure manager were ineffective (paragraph 179).
  - c) No action was taken by Network Rail or Carillion when water flow in gully 1 caused slight erosion to the gravel surface of the new drainage trench before the works were completed (paragraph 185).

- 90 With regard to railway operations, RAIB identified the following causal factors:
- Network Rail did not have suitable arrangements in place to allow timely and effective adoption of additional operational mitigations in case of extreme rainfall which could not be accurately forecast (paragraph 189).
  - Although aware of multiple safety related events caused by heavy rain, route control staff were not required to, and did not, restrict the speed of train 1T08 on its northward journey from Carmont to Stonehaven (paragraph 225).
  - The signaller and driver were not required to, and consequently did not, restrict the speed of train 1T08 to below that normally permitted (paragraph 246)

Each of these factors is now considered in turn.

### Design and performance of the drainage system

**91 Had the drainage system been installed in accordance with the design, it is highly likely to have safely accommodated the flow of surface water on 12 August 2020. However, as installed, the drainage system was unable to do so.**

92 The installation of a new drain in 2011/12 was undertaken as part of a scheme designed to mitigate the risk of earthwork failure in an area of known risk (paragraph 24). The drain was intended to accommodate flows with a 1 in 100 year *return period* and it was sized to do this in accordance with a commonly accepted design methodology (see appendix N). This design assumed that water reaching the surface of the drain would be distributed along substantial lengths of drain, the normal way in which this type of drain operates. It did not consider water reaching the gravel surface as a relatively large flow concentrated at one location. In addition to allowing for inflow distributed along the drain surface, the design also allowed for water reaching the new pipework through pipes from a burn and from an existing drainage ditch (see paragraphs 94 and 96).

93 The drain installed along the cutting crest in 2011/12 drained an area of predominantly agricultural land rising to a ridge about 390 metres from the railway and up to 55 metres above it. This land sloped at typically 1 in 9 towards the railway, although not always in a direct line towards it, until it met the drain located at the top of the cutting around 20 metres above the railway. However, towards the north end of the cutting, the edge of the field was further from the railway and formed the top of a natural funnel feature located outside the railway boundary fence, with the bottom of this feature forming a channel running perpendicular to the railway. The channel sloped downwards to reach the railway at the north end of the cutting (figures 25 and 26).



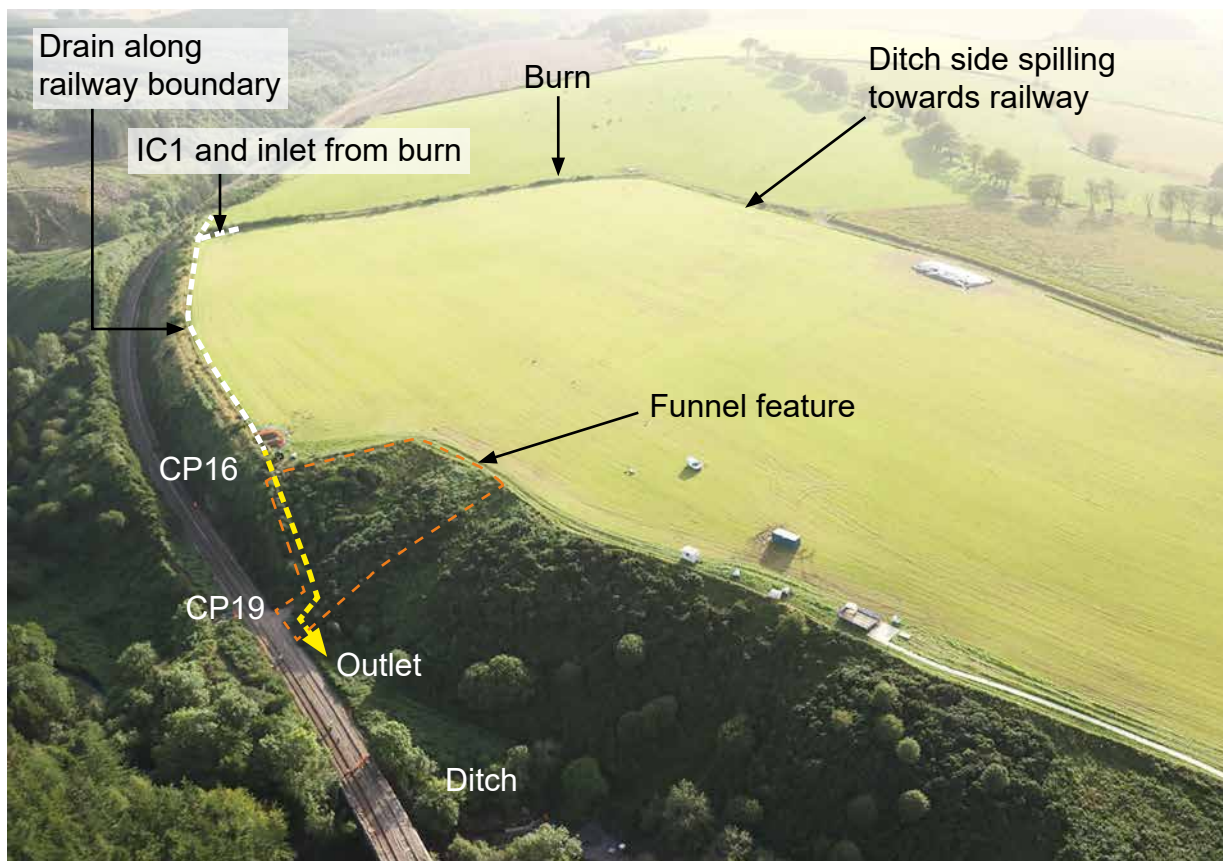

Figure 25: Post-accident aerial image of 2011/12 drainage system's catchment area (Network Rail)

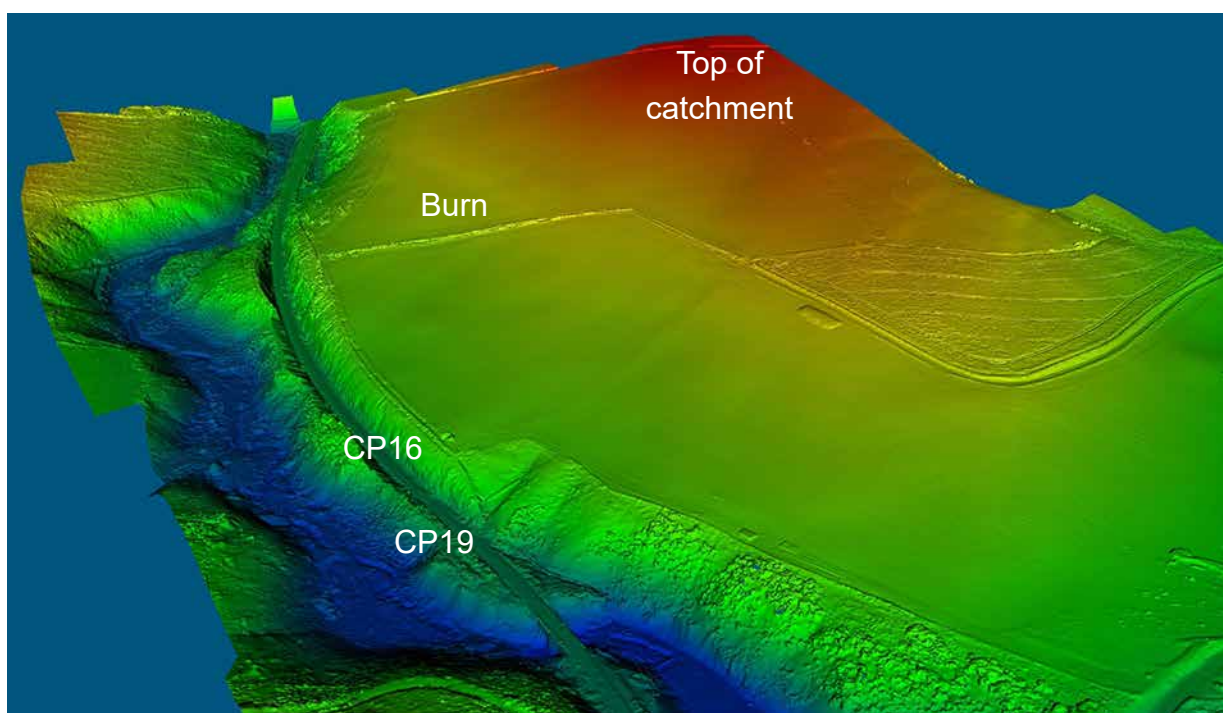

Figure 26: Catchment topography from 2020 LiDAR<sup>5</sup> data. The colour represents altitude

<sup>5</sup> Light detection and ranging (a technology used for surveying).

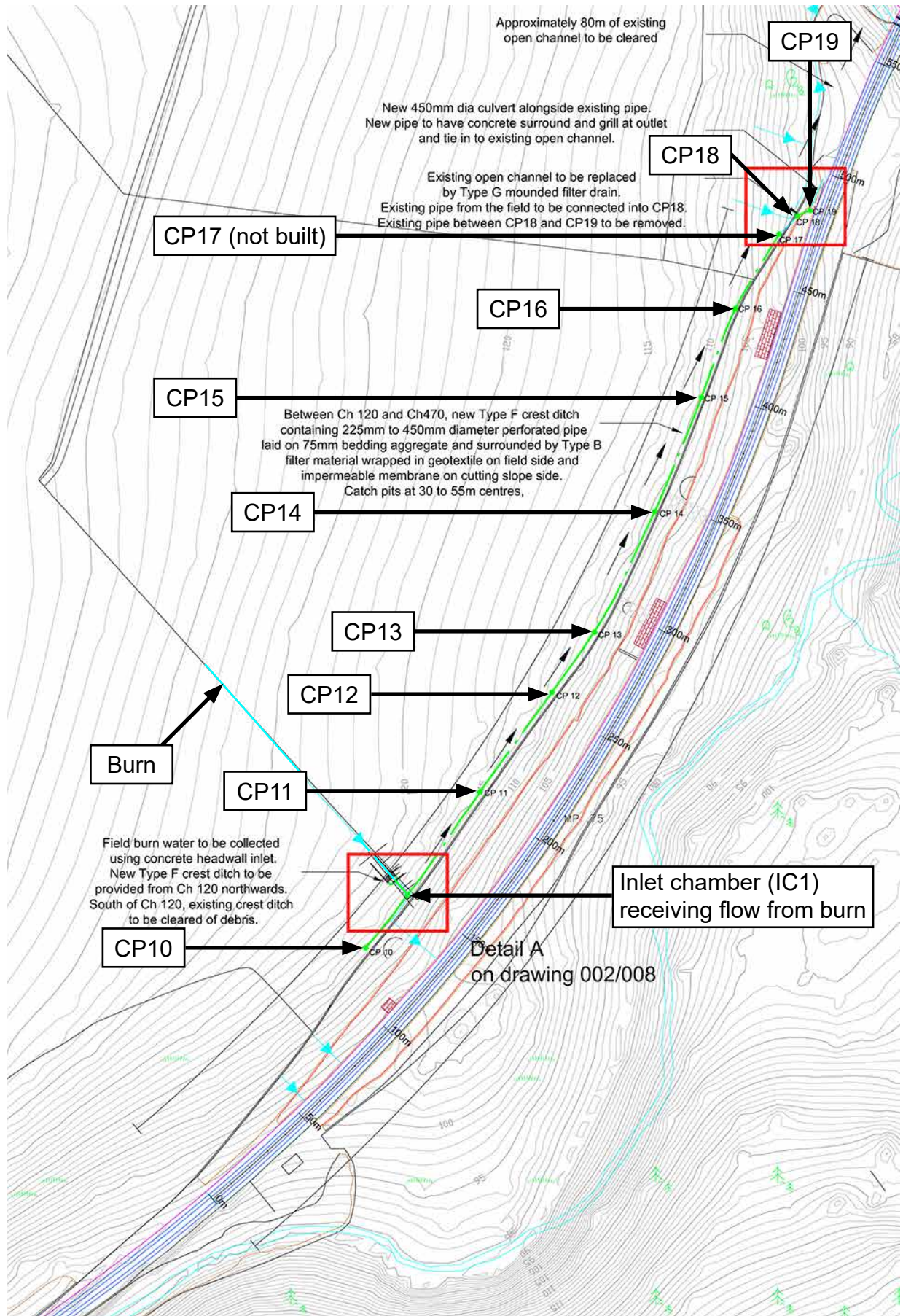

Figure 27: Drain design – plan. Annotated version of Arup drawing 002/001 issue 4. As-built layout differs

94 Approximately 3.08 hectares of land drained into the burn which ran perpendicular to the railway at the highest part of the cutting crest (paragraph 25), before entering the drain at an inlet structure close to its southern end.<sup>6</sup> A short pipe connected the inlet structure to a chamber designated IC1, situated between CP10 at the south end of the drain and CP11. The drain ran northwards, as a gravel-filled trench containing a perforated pipe, for a distance of 306 metres from CP10, passing through IC1 and five further catchpits before reaching CP16 at the top edge of the funnel feature (figures 25 and 26). In total, approximately 7.43 hectares of land sloped towards the length of drain between CP10 at its southern end, and CP16. The *topography* (shape of the ground surface) led to the surface runoff being distributed along this entire length. The ground surface undulated slightly along this length of drain, but the pipe within the trench fell gradually northwards (figures 27 and 28).

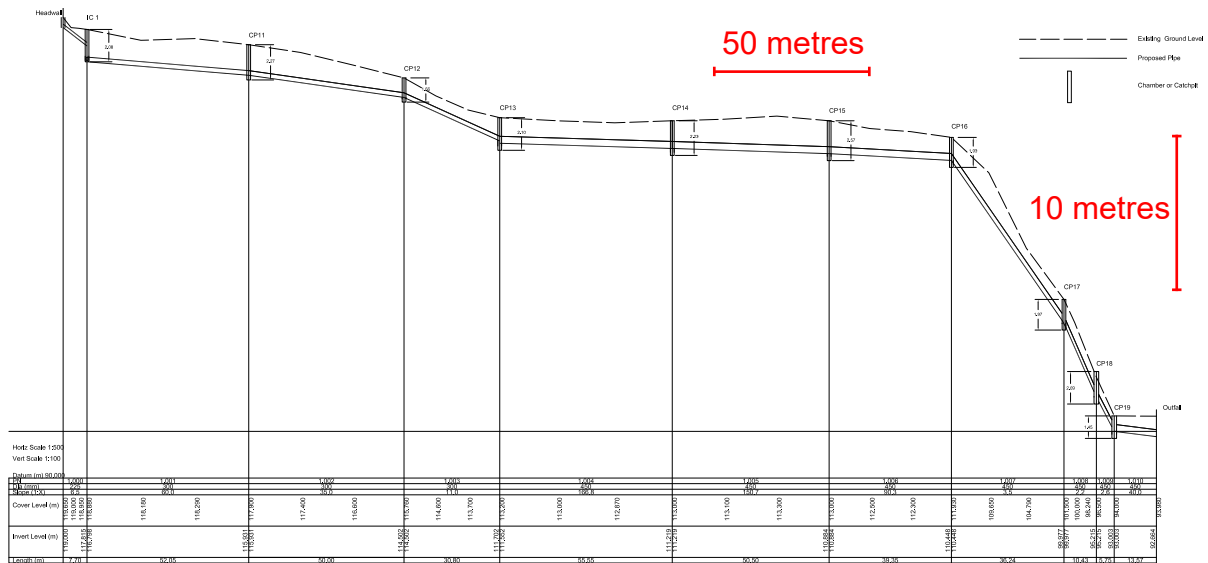

Figure 28: Drain design – elevation with exaggerated vertical scale. Annotated version of Arup drawing 002/005 issue 3. As-built layout differs

95 Approximately 3.57 hectares of land sloped towards the top of the funnel, a relatively large area because a substantial part of this land did not slope directly towards the railway (figure 29). The upper part of this catchment was remote from the railway, and upslope of a ditch running along a field boundary approximately parallel to, and around 230 metres from, the crest drain (figure 25). Aerial photography and witness evidence indicate that this was dug in about 2011 by Carillion alongside a stone track built to provide access for the cutting stabilisation and drainage works. Post-accident surveys showed that the bed level at the ends of this ditch was higher than parts of the bank on the railway side of the central part of the ditch. This meant that, if water inflow exceeded the rate of percolation into the underlying ground, water accumulating in this ditch would spill over its eastern bank onto areas of land which sloped towards the funnel, a similar route to that followed by water before excavation of the ditch.

<sup>6</sup> Areas are based on a 2020 LiDAR survey and differ from those used for drain design (refer to appendix N).

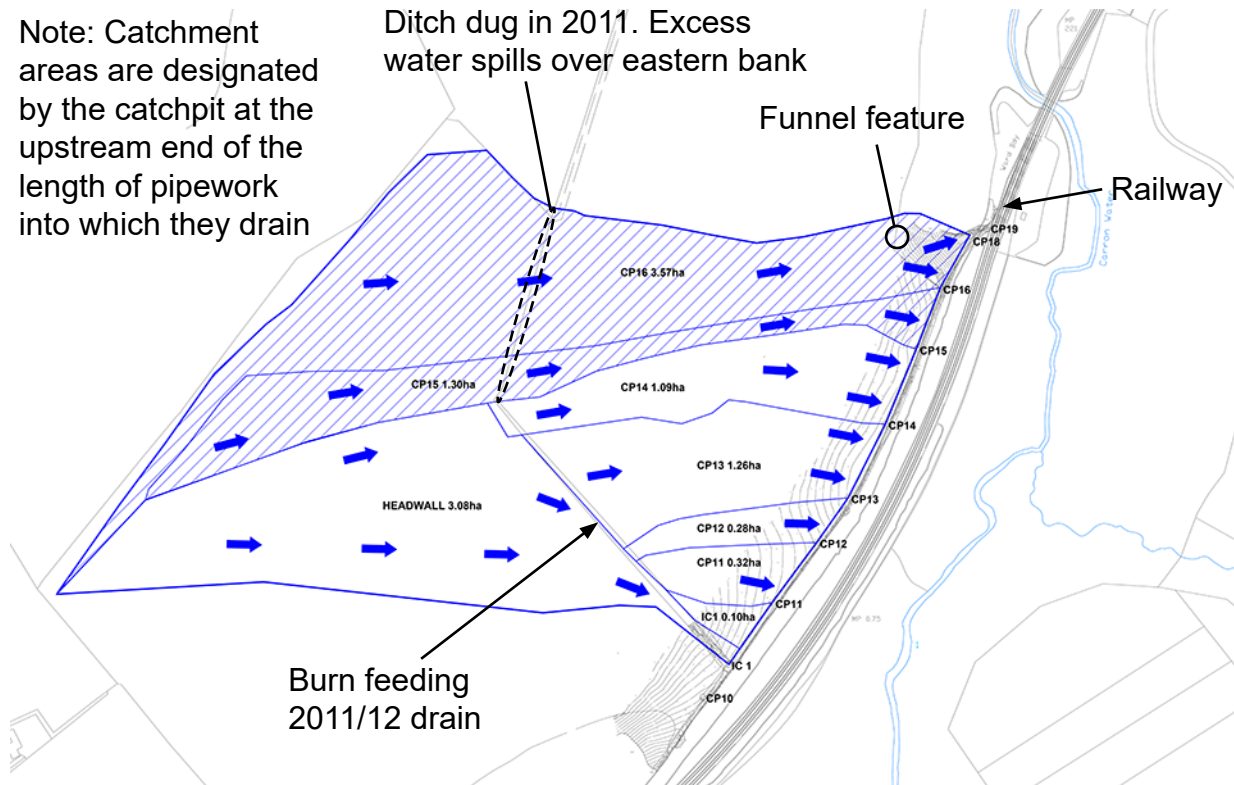

Figure 29: Drain catchment areas based on 2020 LiDAR data (AECOM)

- 96 The 2011/12 drain continued from CP16 as a perforated pipe in a gravel-filled trench, now sloping at about 1 in 3, as it ran for a distance of 40 metres down the east side of the funnel from CP16 to CP18, following the natural slope (figure 26). It continued in the same direction for about a metre beyond CP18 before reaching the natural channel formed by the funnel feature, where it turned sharply towards the railway and CP19 with the pipe gradient steepening to 1 in 2.4. About 7 metres beyond CP18, and 5 metres before reaching CP19, the fill material above the pipe changed from gravel to locally dug fill, similar to the surrounding natural ground (figure 4 and figure 30). At about the same location, the pipe changed from a perforated to an unperforated type. The perforated drain with gravel collects and transports water towards the outlet, and is sometimes described as a filter drain. The unperforated pipe covered by locally dug material is only expected to transport water and is sometimes described as a *carrier drain*.
- 97 Before construction of the drain in 2011/12, most surface water reaching the funnel would flow into a ditch running along the lower part of the funnel, designated the pre-2010 ditch in this report. A pre-construction survey, undertaken in May 2010, shows this ditch was connected through clay pipes into the railway drainage system alongside the track (figures 31, 32 and 33). The pre-2010 ditch and pipe leading from this were absent when the accident occurred (see paragraphs 134 to 137).

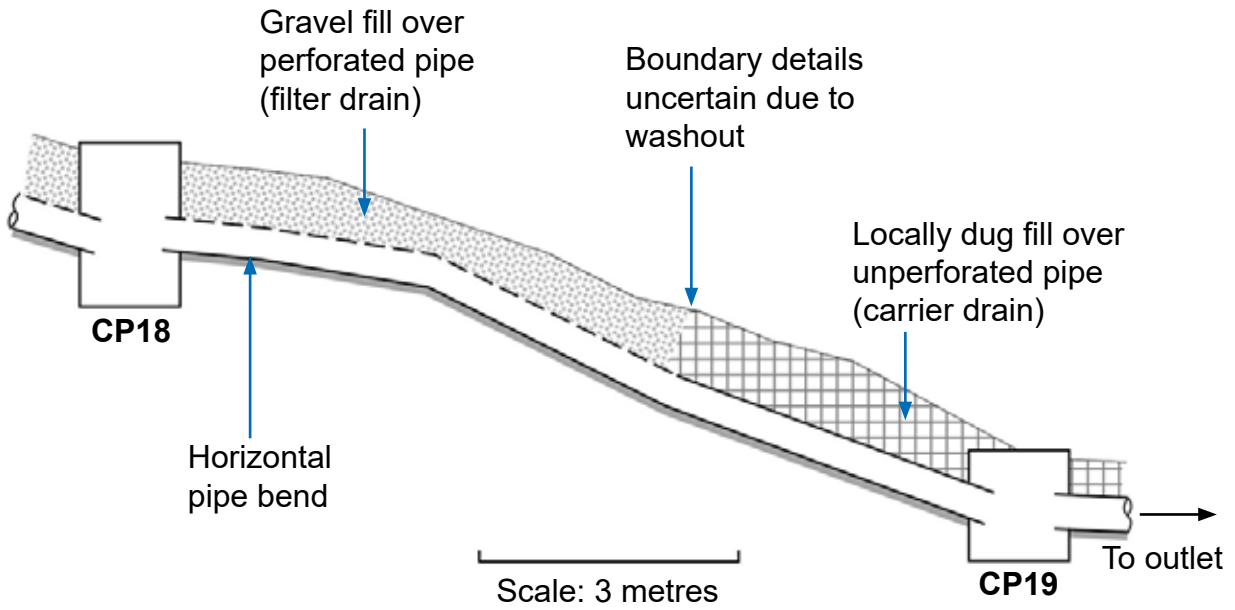

Figure 30: Drain profile downstream of CP18 showing fill before washout (derived from AECOM report appendix S)

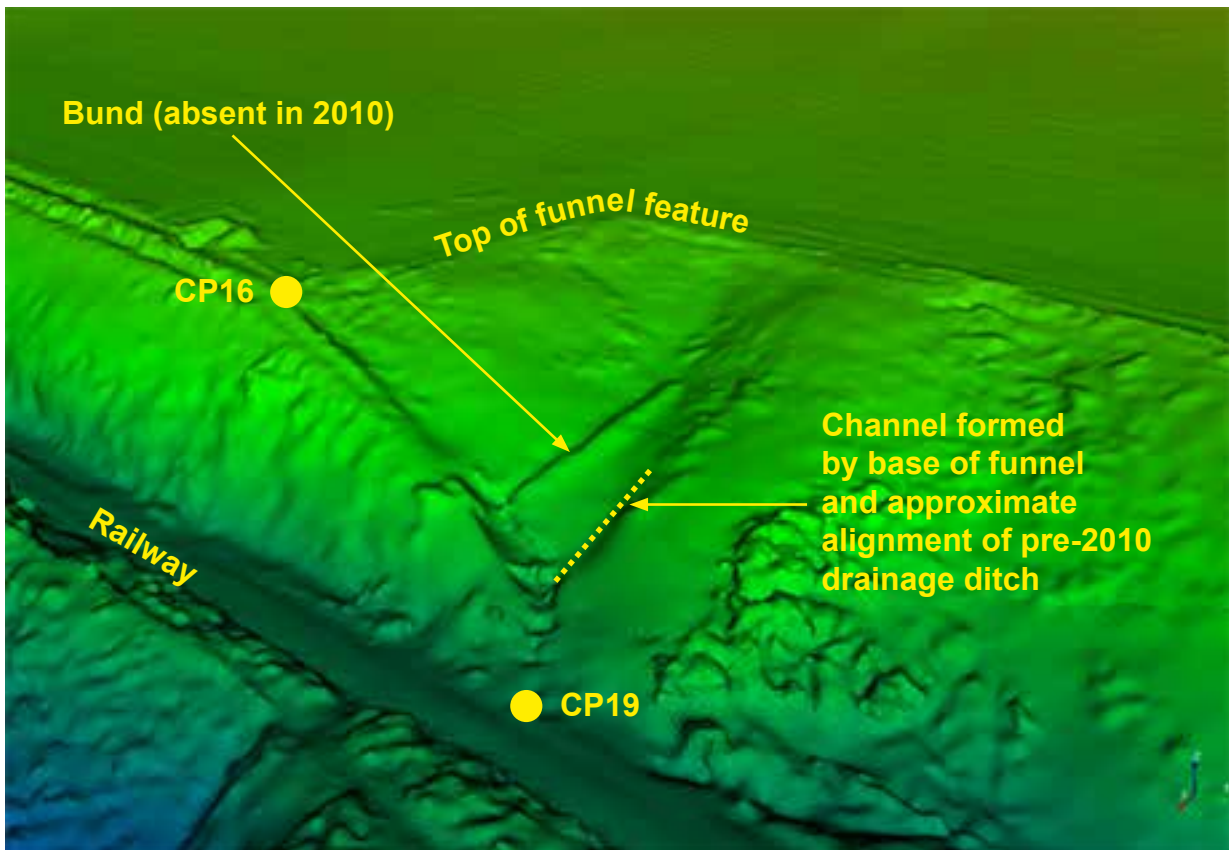
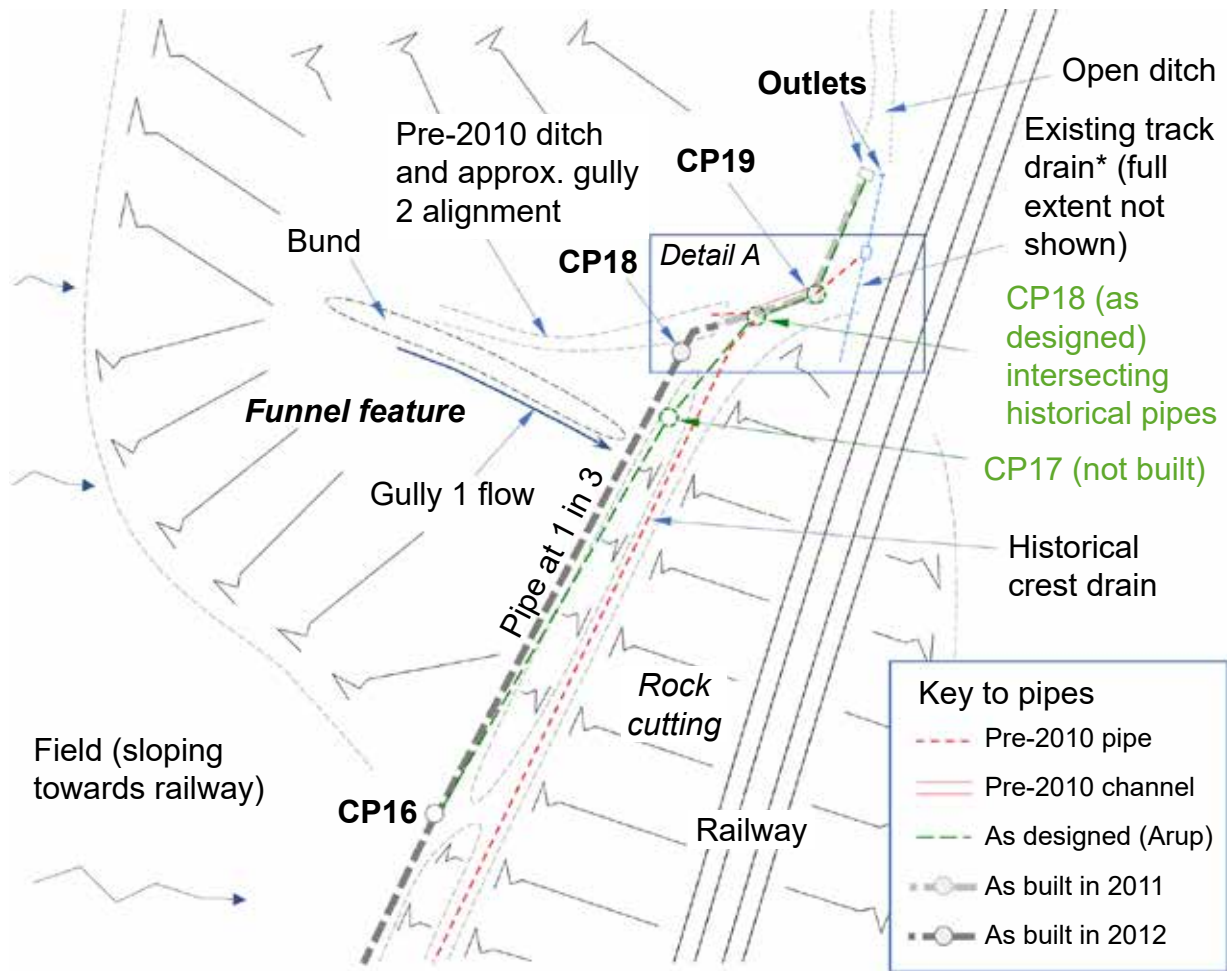

Figure 31: Pre-construction funnel details shown on 2020 (post-accident) LiDAR data



\*Pre-2010 track drainage not altered by 2011/12 works

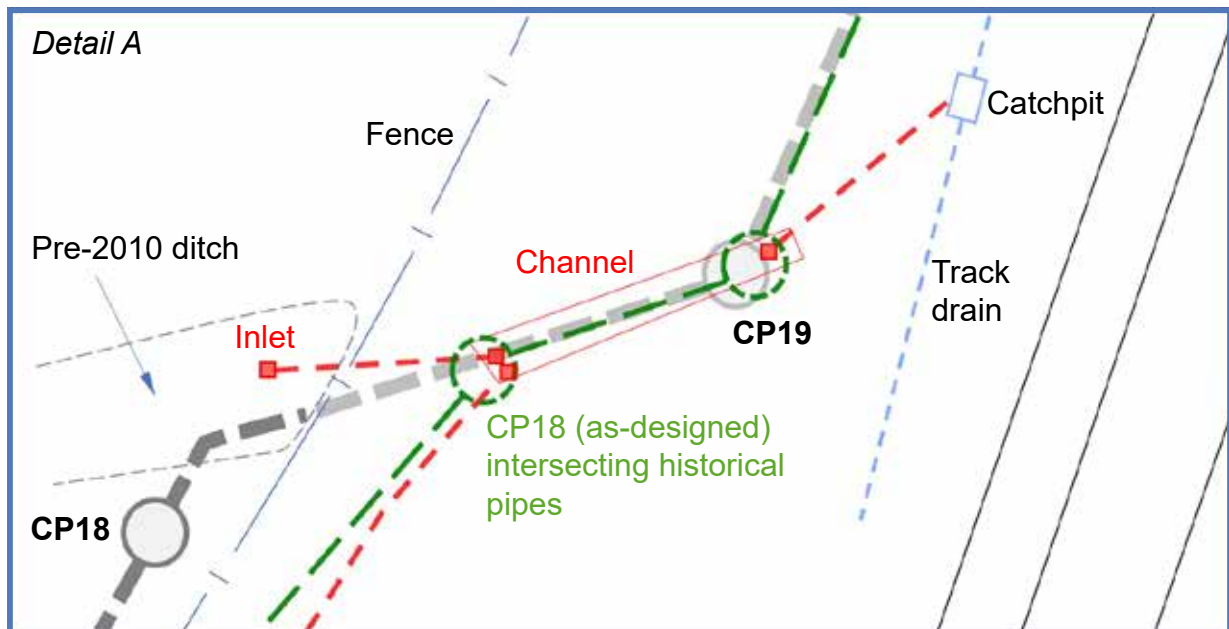

Figure 32: Sketch plan showing drain layout and nomenclature

2011/12 catchpit positions and inferred pipe alignment added by RAIB for reference

As-designed and as-built positions of CP16 and CP19 are both near the locations shown

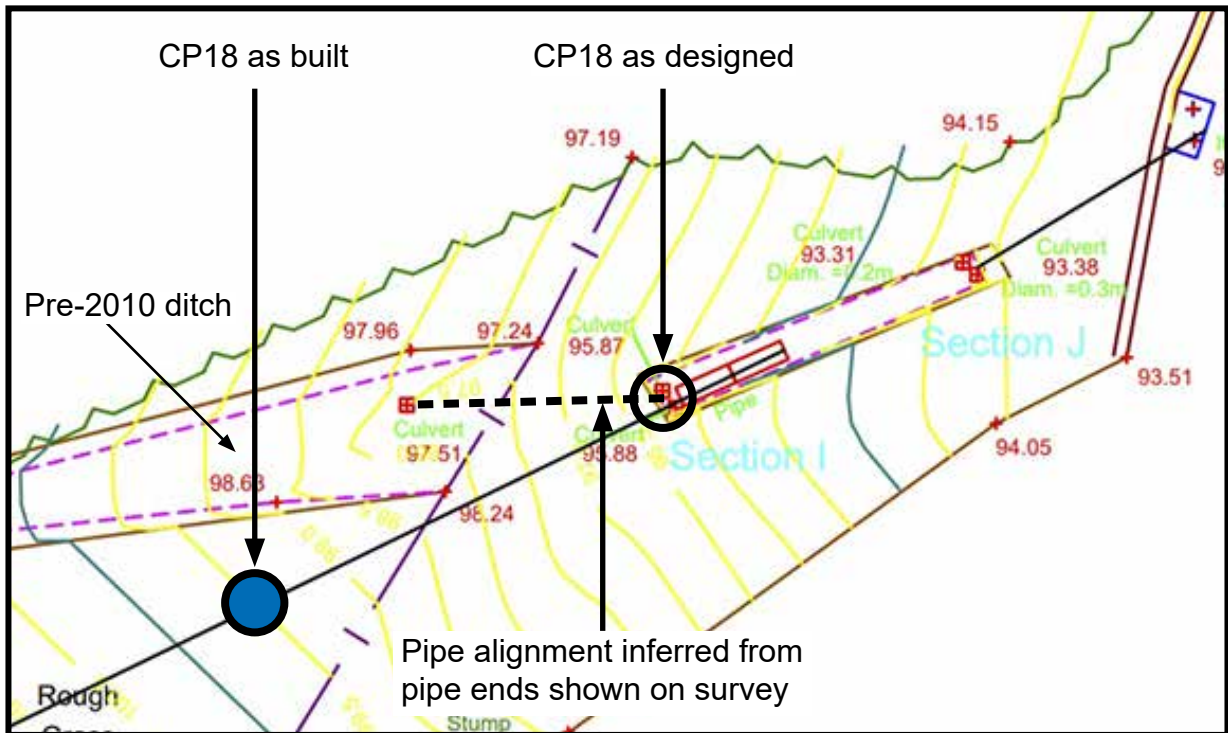
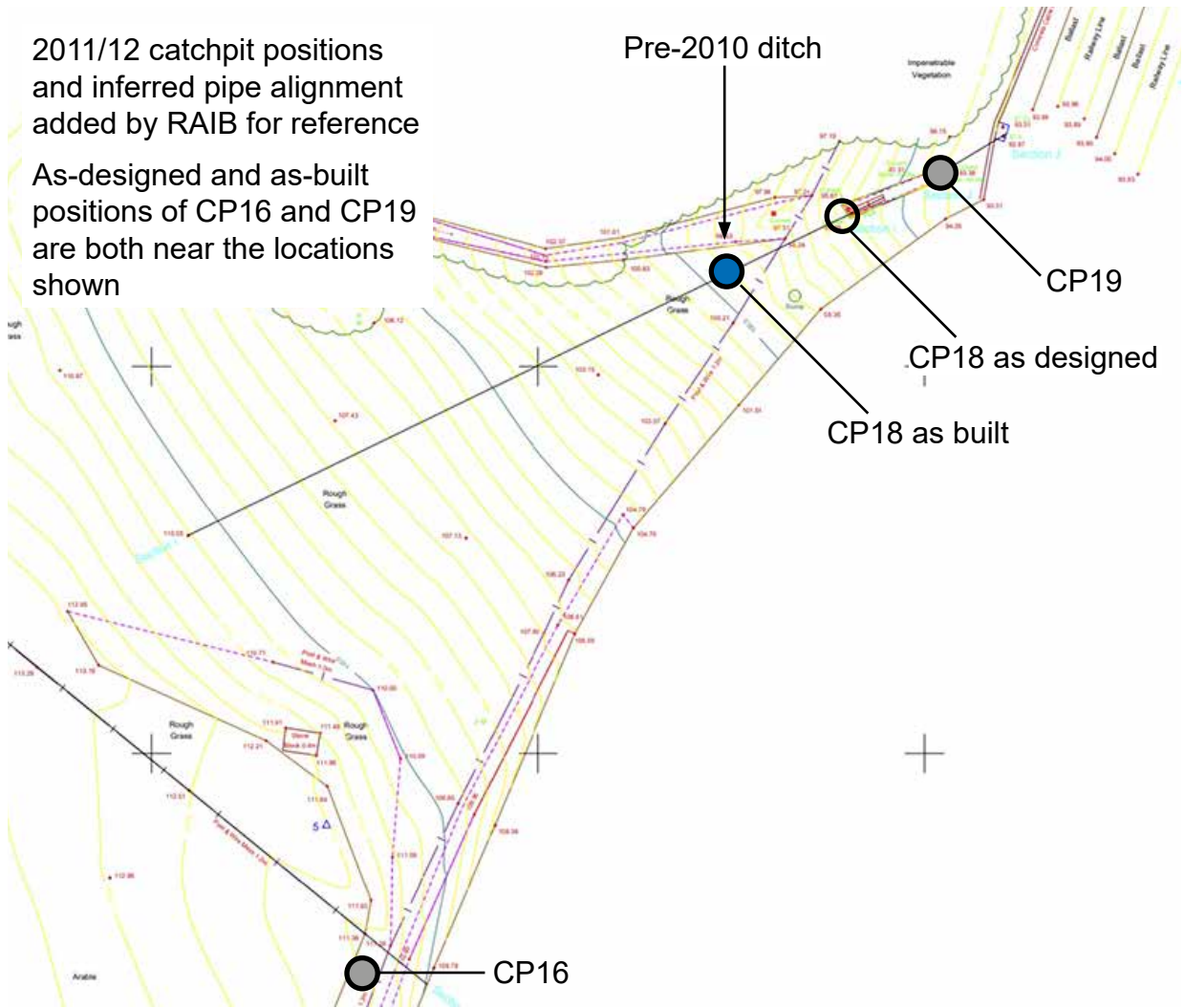

Figure 33: May 2010 survey showing pre-2010 ditch and pipe



Figure 34: Bund viewed facing towards the 2011/12 drain post-accident after clearance of vegetation

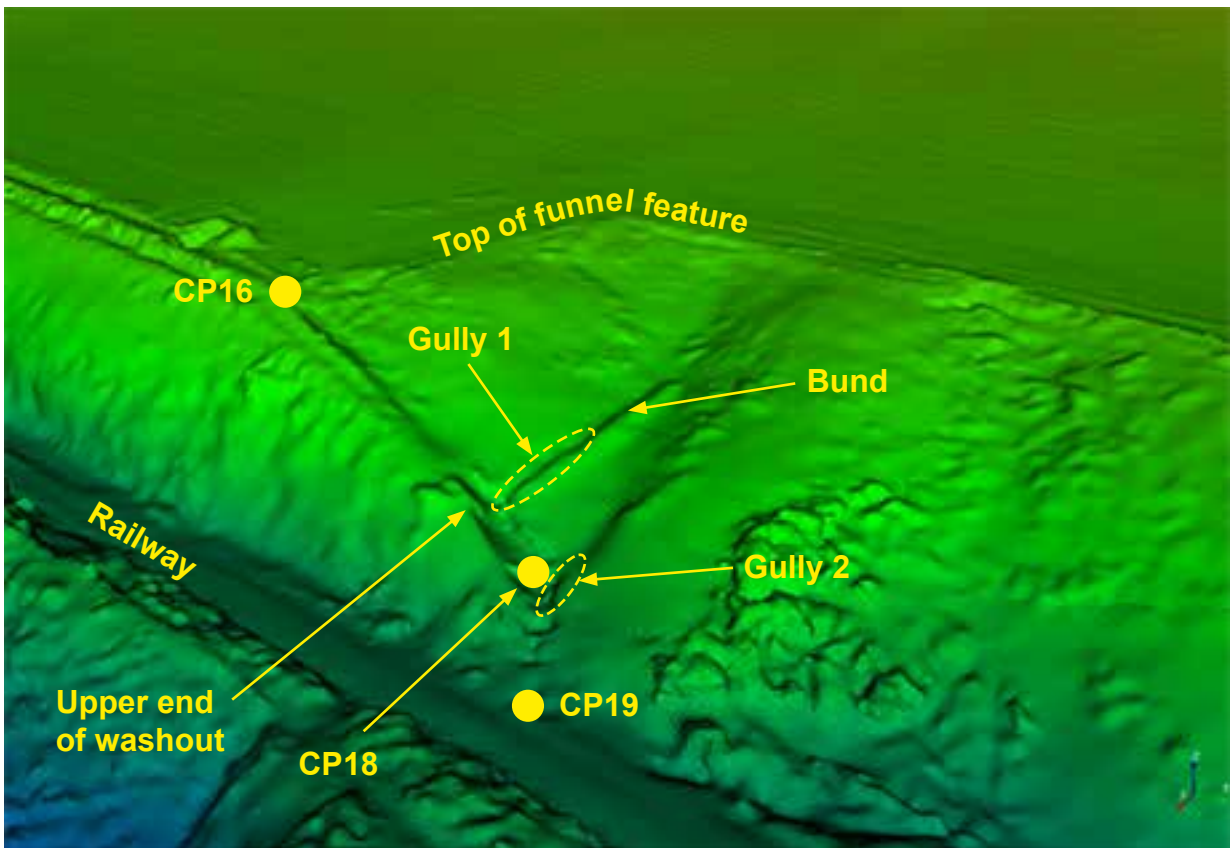

Figure 35: Post-accident funnel details shown on 2020 LiDAR data



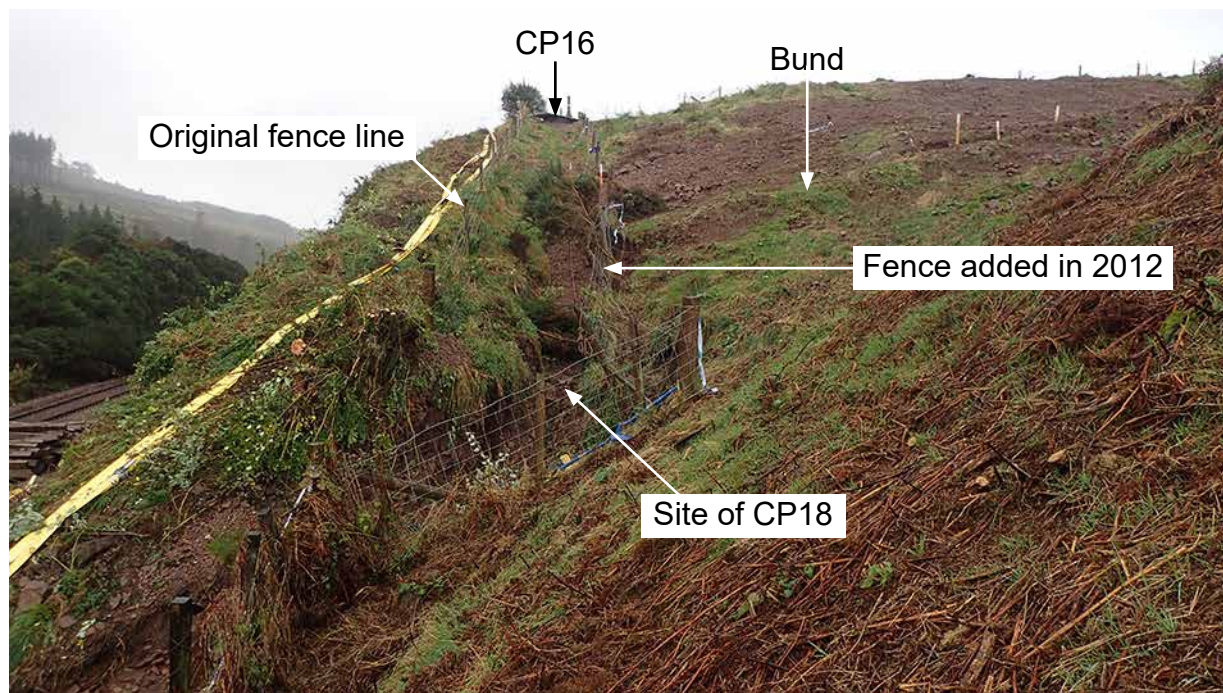

Figure 36: Funnel area post-accident after clearance of vegetation and removal of CP18

- 98 A post-accident survey, conducted over several days as the gorse-cover was carefully removed from the funnel surface, located a bund (artificial ridge) which was almost certainly absent before the 2011/12 drain was constructed (figures 34, 35 and 36). This bund intercepted most water flowing into the funnel and guided it towards the 2011/12 drain at a point about 7 metres upslope of CP18. A gully, with a shape consistent with being caused by water erosion, had formed on the upslope side of this bund and is designated gully 1 in this report (figures 32 and 33). Another gully had developed in the lowest part of the funnel, on the line of the pre-2010 ditch and passing close to CP18 (gully 2). It intersected the 2011/12 drain immediately downslope of CP18. The effect of the bund was observed and recorded during wet weather on 25 August 2020 when water flowed along gully 1 without a corresponding flow in gully 2.
- 99 Site inspection by RAIB in the period immediately after the accident found that:
- The debris on the track comprised a pinkish-grey granite gravel with some gravel and cobbles of grey stone (figures 20 and 37).
  - The gravel-filled 2011/12 drain had washed out for a distance of about 9 metres upslope of CP18 and for the full 6 metre length of gravel-filled drain downslope of this catchpit. Most of the material surrounding the carrier drain upslope of CP19 had remained in place. The drainage pipe in the bottom of the trench was partly exposed but was undamaged and continued to carry water (figures 17, 18 and 30).
  - The pinkish-grey granite gravel on the track was similar to that found in the drain immediately upslope of the washout (figure 37), indicating that this gravel had reached the track from the drain.
  - The grey stone on the track was similar to that found on and in the ground around the drain, an observation consistent with stones being eroded from the side of the drain and/or being washed from the surrounding ground surface by the water flows responsible for washing gravel from the drain.

- e) Very close to the 2011/12 drain, gully 1 was deeply eroded to a depth more than halfway down the drain, something which could only occur after washout of significant amounts of drain gravel (figure 38).
- f) The top end of the washout of the 2011/12 drain was about 2 metres upstream of the point where gully 1 met this drain (figure 17), and there was no evidence of the drain being damaged by water flows above this point. Limited regression upstream of gully 1 would be expected as the gravel would not be stable with a vertical face, and eddying of inflowing water would cause some erosion just upstream of the point of entry into the drain.
- g) Gravel from the drain was found on top of CP18 (figure 39), demonstrating that flows from gully 1 were sufficient to wash out gravel from the drain and that washout upslope of CP18 was not a regression of a washout initiated downslope of this catchpit.
- h) The drain downslope of CP18 was at a steeper gradient than upslope of CP18, so flows sufficient to cause washout upslope of this catchpit would also be sufficient to cause washout downslope of the catchpit. This does not discount the possibility of water from other sources influencing washout downslope of CP18.
- i) There was no physical evidence demonstrating whether washout upslope of CP18 was initiated before, concurrently with, or after washout downslope of the catchpit.
- j) The base of gully 1 contained large stones with some of those further from the 2011/12 drain having local patches of green organic growth indicative of intermittent water flows for a considerable period of time (figure 38).

#### Washout gravel from drainage trench

**100 The gravel in the drainage trench was vulnerable to washout if subject to large flows of surface water concentrated onto a short length of drain.**

#### Post-accident analysis

101 RAIB commissioned AECOM, an international consulting engineering firm with expertise in drainage matters, to model events on 12 August 2020 and to review the drainage scheme as designed by Arup, and as constructed by Carillion. This work used rainfall records provided by the Met Office, a post-accident survey of ground topography obtained using *LiDAR*, post-accident testing of soils in the fields from which water flowed to the washout, and design criteria provided in the 1999 and 2013 versions of the Flood Estimation Handbook (FEH).<sup>7</sup> The 1999 version of the FEH applied when the 2011/12 drain was designed. The 2013 version differs from the earlier version, in part because climate change has made heavier rainfall more likely to occur, so a storm of a particular duration and intensity now has a shorter return period than in 1999.

<sup>7</sup> FEH is developed and maintained by Wallingford HydroSolutions ([fehweb.ceh.ac.uk](http://fehweb.ceh.ac.uk)).



*Figure 37: Landslip debris (left-hand images) and undamaged area of 2011/12 drain between washout and CP16. Surface of drain, probably protected by discarded plastic sheet since around the time it was constructed, shown in lower right image (Police Scotland)*



Figure 38: Gully 1 erosion at junction with 2011/12 drain (ORR/Coffey). Inset shows organic growth in base of gully 1 just outside main picture



Figure 39: CP18 viewed from downslope on 13 August 2020 with the end of gully 2 visible at the upper right of the image

102 On the morning of 12 August 2020, Met Office analysis of rainfall radar data shows 51.5 mm of rain fell between 05:50 hrs and 09:00 hrs at the Carmont accident site (figure 40). Based on this amount of rain falling over a 1 km<sup>2</sup> area, the return period for this event is 144 years using the 1999 FEH methodology and 100 years using the 2013 FEH methodology (table 1).<sup>8</sup> It is the duration which makes this event particularly unusual; the return periods for the most intense 15 minutes of rainfall during the storm are 23 years and 8 years respectively for the 1999 and 2013 methodologies. This was within a wider area of exceptionally heavy rainfall, described by the Scottish Environment Protection Agency (SEPA) as a rare event, causing severe disruption and significant flooding in central and eastern Scotland on 11 and 12 August 2020.<sup>9</sup>

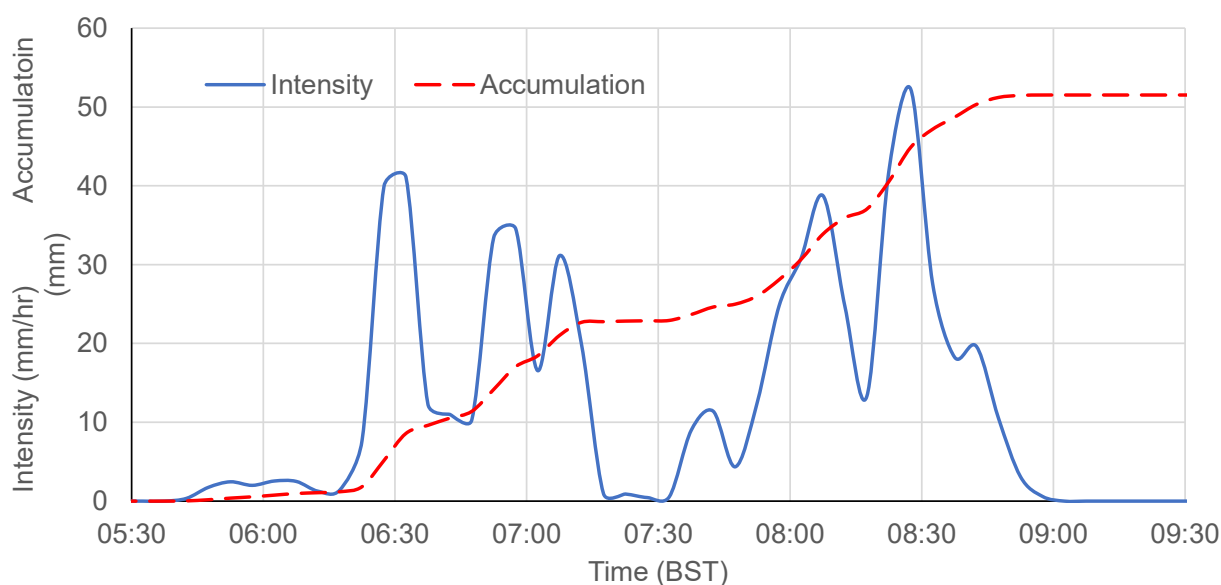

Figure 40: Carmont drain catchment area rainfall on 12 August 2020 (radar data processed by Met Office)

<b>Maximum rainfall on 12 August 2020 at Carmont site (derived from radar data)</b>			<b>Return period (years)</b>	
<b>Duration</b>	<b>Amount (mm)</b>	<b>Start time</b>	<b>FEH 2013 methodology</b>	<b>FEH 1999 methodology</b>
15 min	10.1	08:20 hrs	8	23
30 min	16.8	08:00 hrs	16	46
1 hour	26.2	07:50 hrs	30	74
2 hour	39.8	06:50 hrs	62	111
3 hour	51.1	05:55 hrs	100	144
4 hour	51.5	05:40 hrs	66	82

Table 1: Return period for Carmont drain catchment events on 12 August 2020, methodology based on rainfall over 1 km<sup>2</sup> area

<sup>8</sup> Return period is longer (event less likely) if the same amount of rain falls over a larger area.

<sup>9</sup> A report titled 'Flash Floods of 11 and 12 August 2020 in Central and Eastern Scotland', published by SEPA, gives longer return periods. This is based on areas which received even more rainfall than Carmont, for example the 79 mm which fell in around 3 hours at Cheyne, about 4.6 km (2.9 miles) north-east of the accident site ([sepa.org.uk](https://www.sepa.org.uk)).

- 103 AECOM analyses demonstrated that the 2011/12 drain pipework was of adequate size to carry the surface runoff associated with the rainfall on 12 August 2020 (appendix N). However, satisfactory drain performance also depended on the runoff percolating through the gravel and into the pipework or reaching the pipework through a connection from another drainage system.<sup>10</sup> Site observations indicated that this had not happened on 12 August 2020 so AECOM undertook an *overland flow* analysis to establish the amount and locations at which surface water reached the drain (see paragraph 104). Predicted flows from gully 1 were compared with the amount of water which could percolate through the gravel into the pipe to determine the amount of water flowing over the surface of the 2011/12 drain at the downstream end of gully 1. A *sediment flow* assessment was then used to establish whether the water flowing over the gravel would cause it to be washed out of the drain.
- 104 Surface runoff (overland flows) associated with rainfall on 12 August 2020 was modelled by AECOM using a range of values to cover uncertainties about the values of some parameters. The most significant uncertainty was the amount of rain which flowed over the ground as runoff rather than immediately percolating into the ground. The effect of the bund in concentrating flow into gully 1, and thus into the area of washout, is clearly shown in figures 41 and 42 which give overland flows using best estimate parameters. Output from this analysis included the variation in flow with time in gully 1, a flow which peaked at 140 litres/sec, equivalent to 0.14 m<sup>3</sup>/sec. (figure 43). Details of the surface runoff analyses, and the ranges of results obtained are summarised in appendix H.
- 105 AECOM estimated that, as designed, about 14 litres/sec of water could percolate through the gravel into each metre of drain. The amount percolating in August 2020 was probably less than this due to fine soil particles accumulating in the gravel after the drain was constructed (see paragraph 148). This capacity of up to 14 litres/sec was considerably less than the likely amount of water reaching the short length of drain at the downstream end of gully 1. Consequently, water would be expected to flow over the surface of the drain gravel.
- 106 In order to address uncertainties about the amount of surface runoff, sediment flow was assessed on the basis of the 2011/12 drain being subject to a peak surface flow of 86 litres/sec, considerably less than the peak gully 1 flow of 140 litres/sec obtained using best estimate overland flow analysis. Site test data was obtained regarding likely gravel particle size, a maximum size of 40 mm and a typical size of 25 mm. AECOM demonstrated that the 86 litres/sec flow was sufficient to transport the drain material downslope and so demonstrated its vulnerability to washout if, contrary to the designer's intention, it was subject to significant surface flows.
- 107 Reviewing both the sediment analysis and gully 1 flows associated with other ground parameters, RAIB has concluded that the washout probably occurred between about 08:15 hrs and 09:00 hrs, corresponding with gully 1 flows comparable to those shown in figure 43.

---

<sup>10</sup> The connection from the burn at the south end of the 2011/12 drain and the as-designed (but not as-built) connection is described at paragraph 134.

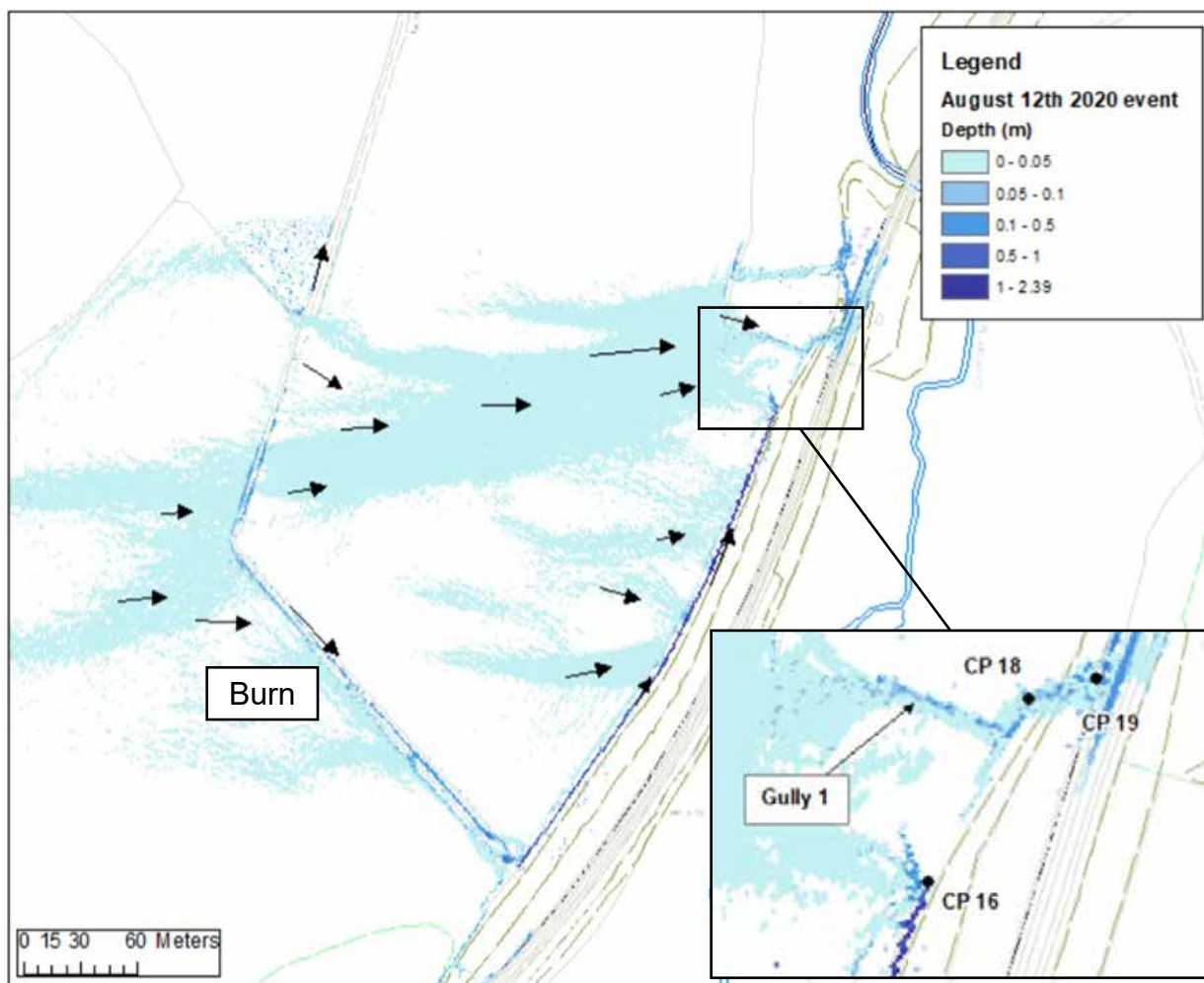

Figure 41: Overland flow maximum depths, best estimate analysis (AECOM)

108 The AECOM analysis also predicted the amount of material washed from the drain and surrounding ground, together with how this would be deposited on and near the railway. It demonstrated that the observed washout of the material from the drainage trench was consistent with a range of realistic parameter values. However, the uncertainties around the amount of surface runoff, and the need for the sediment flow assessment to adopt parameters which could not be established with certainty from testing site material, mean that the AECOM analysis should not be viewed as providing a precise reconstruction of what actually happened on 12 August 2020.

109 The sediment analysis based on 86 litres/sec flow predicted that about 13 m<sup>3</sup> of material would be eroded from the drain and deposited in a debris fan extending over the railway (figure 44). Based on LiDAR surveys undertaken by Police Scotland, RAIB estimated that 23 m<sup>3</sup> of material was eroded from the drain and surrounding ground, with the fan of debris covering the track and surrounding area estimated as having a volume of 16 m<sup>3</sup>. The fan value excludes some material deposited in a ditch alongside the railway and the finer soil particles which would have been washed towards, and into, Carron Water.

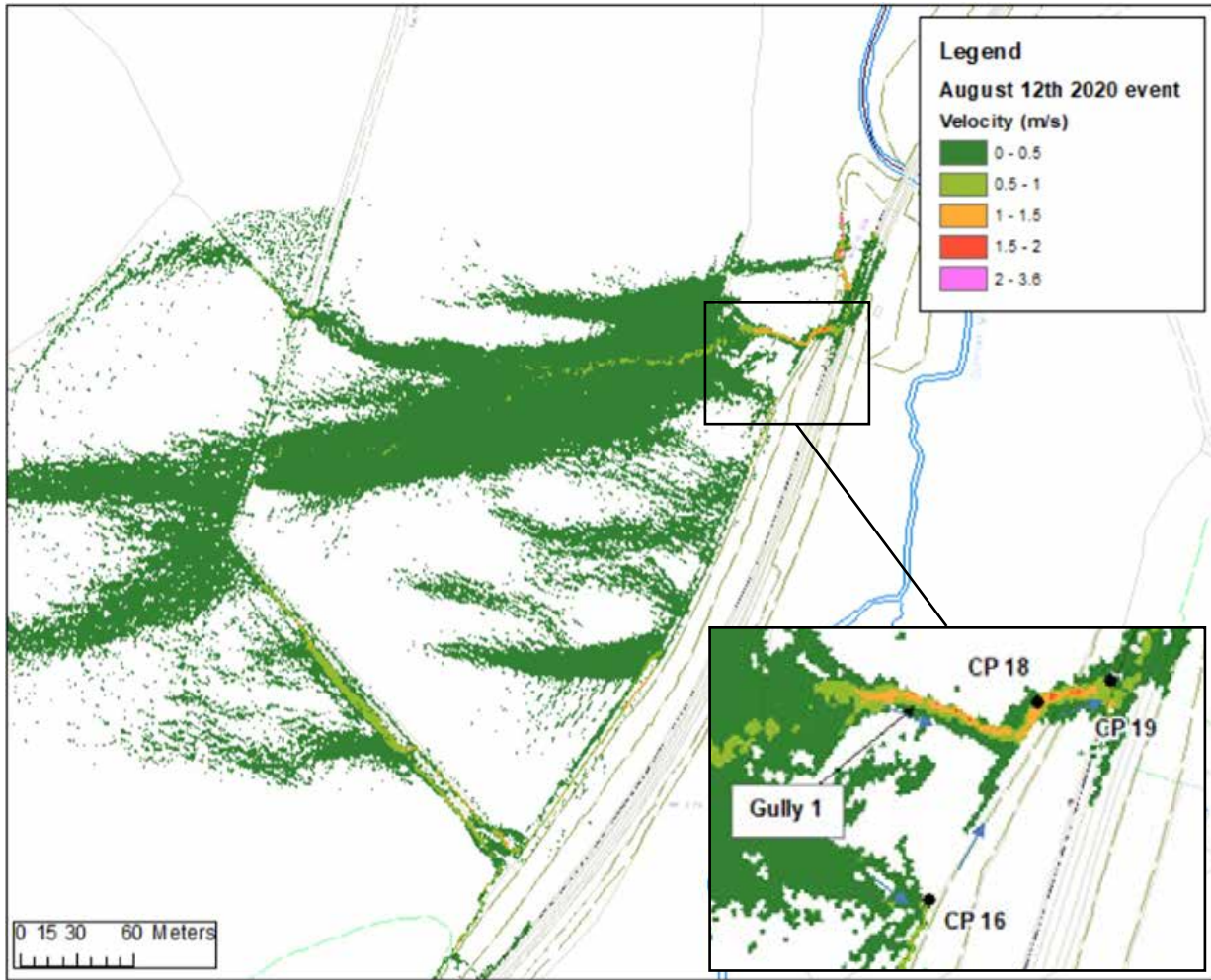

Figure 42: Overland flow maximum velocities, best estimate analysis (AECOM)

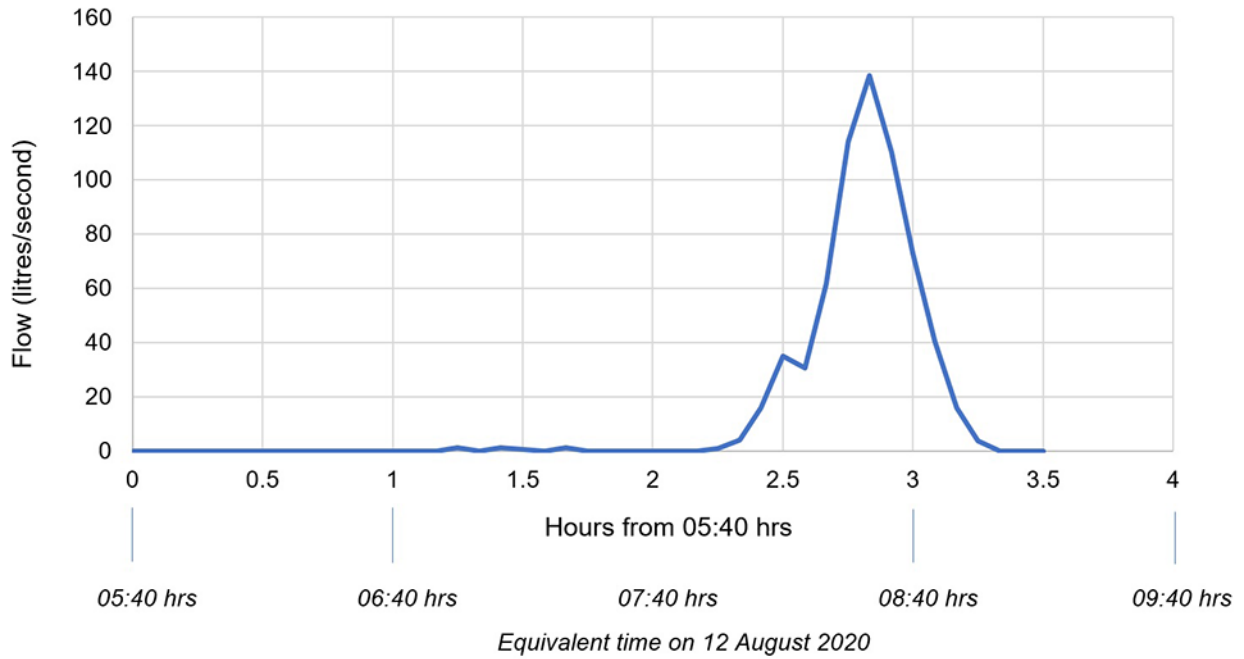

Figure 43: Gully 1 flow development, best estimate (AECOM)



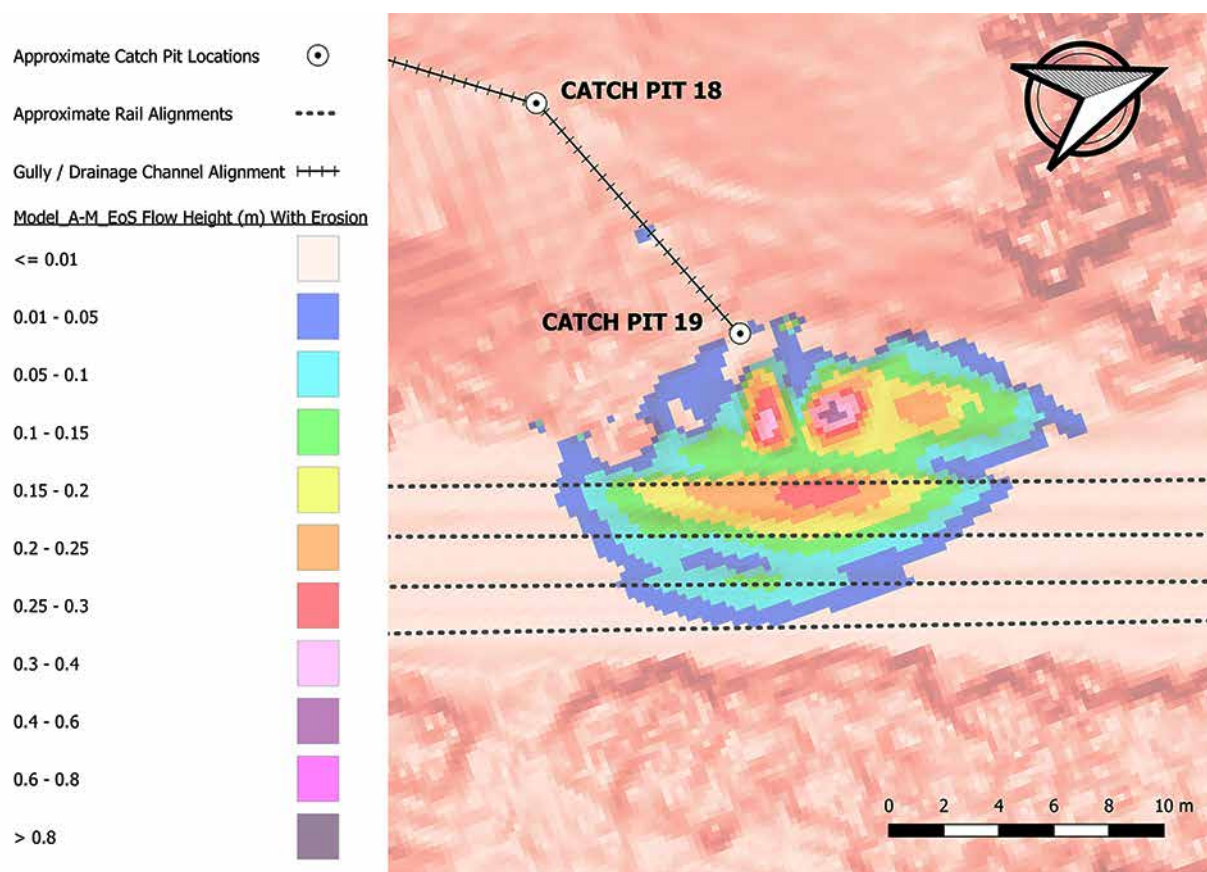

Figure 44: Theoretical deposit depths (in metres) for ~86 litres/sec flow (AECOM)

### Washout design consideration

110 The washout was, in part, a consequence of the relatively steep drain slope of approximately 1 in 3. AECOM has not identified, and RAIB is not aware of, any requirement or good practice guide which would suggest this was inappropriate for the intended use of the drain (guidance had been available since before 2010 suggesting the slope would be inappropriate for drains and pipes used in some other circumstances).

111 Arup's response to a query raised during construction (see paragraph 120) demonstrates it had assessed washout risk in the context of surface flows reaching the drain in a way which allowed them to percolate through the gravel and into the pipe, the intended method of operation. It had not considered, and there was no reason for Arup to expect, water reaching the drain as a concentrated flow, such as that from gully 1.

112 A complete blockage in CP17 (not built), CP18 or CP19 would have caused a washout of the gravel during periods of heavy rain. Events on 12 August 2020 show that, depending on the nature of the rainfall event, this could have resulted in debris being deposited on the track. There is no evidence that this risk was assessed during the design process. Arup stated there was no requirement to do so under design approaches advocated by Network Rail, the national highways authorities<sup>11</sup> or ‘Sewers for Scotland’.<sup>12</sup> Given the low likelihood of such a blockage event and the low likelihood of recognising the potential consequences for railway safety, it is unlikely that undertaking a risk assessment would have resulted in action affecting events on 12 August 2020, as these were not related to a pipe blockage.

### Summary of rainfall and drainage analyses

113 In summary, RAIB has concluded that the washout on 12 August 2020 occurred because a bund running across the slope, perpendicular to the railway, had concentrated flows into gully 1 to the extent that the capacity of the drain was exceeded and the gravel in the steeply sloped section of the drainage trench was washed out onto the track below.

### Construction activities

**114 Carillion did not construct the drain in accordance with the designer’s requirements.**

#### Drain planning

115 Carillion commenced construction on site in January 2011 with the installation of rockfall netting on both sides of the cutting, an activity that was completed in June 2011. The work on the down-side cutting face was planned to take place before drain construction work commenced, to prevent site congestion at the crest of the slope. A temporary access staircase was constructed of wood down the slope at the north end of the cutting, to provide a walking route for staff to access the east side of the railway by passing under the nearby bridge 325. In April 2011, with rock-netting work nearing completion, the temporary staircase was dismantled to allow work on the drain to commence.

116 In preparation for construction work commencing, Carillion’s site engineer prepared a Work Package Plan: ‘WPP-07 Drainage works’. This document described how work would be undertaken both inside and outside the railway boundary fence. Revision 001 was issued on 31 March 2011, and this was subsequently updated until revision 005 was issued on 3 May 2011 before drainage work commenced.

117 As part of planning for this part of the work, Carillion’s site engineer submitted various technical queries (TQs) to Arup. The TQ form was a single page document which Carillion used to formally raise questions or queries about the design or drawings. Most of the TQs raised during the contract related to the rock-netting works, but TQ19 and TQ20, which were submitted at the same time, specifically related to the steeply sloping section of drain. For drainage issues, Arup’s geotechnical engineer, who acted as lead designer, forwarded the TQs to the Arup drainage designer.

<sup>11</sup> Transport Scotland, National Highways, Welsh Government, Department for Infrastructure Northern Ireland.

<sup>12</sup> Sewers for Scotland, Scottish Water, 2<sup>nd</sup> edition, 2001.

- 118 TQ19 sought approval to omit CP17, which was shown on drawings part-way down the steep slope between CP16 and CP18, on the basis that it would be ‘particularly difficult to install on the slope’. Arup accepted this proposal on 2 May 2011, noting that omission of the catchpit would require a deeper excavation for the pipe.
- 119 On 18 April 2011, drainage materials including pipes and catchpits were delivered to the site in preparation for work to commence. The following day, Carillion’s site engineer submitted TQ20 to Arup. It stated:
- ‘Can we make the drainage section which runs down the north slope of the down side a carrier pipe rather than a filter drain?’<sup>13</sup>*
- I would think the single size aggregate which is used for backfilling the drainage section will be washed out during high flows of water.*
- Will the drain actually collect water on this gradient? It seems that the water runs down the steep slope (parallel to the drain) rather than towards the line (perpendicular to the drain).’*
- 120 It is uncertain what triggered Carillion’s concern about the risk of aggregate washing out. Arup’s drainage designer was unavailable to respond to TQ20 immediately, but the lead designer provided a provisional response. This was superseded by a final response from the drainage designer which was issued on 2 May 2011 and stated:
- ‘Retain filter drain between CP16 and CP18.’*
- 121 Internal Arup emails show that the drainage designer did not expect high flows of water on the drain surface as all water would filtrate to the pipe in the trench. He also expected that the *geotextile* fabric would provide protection against washout. Neither the drainage designer, nor other members of Arup’s team, were aware that this geotextile fabric would later be omitted in some areas during construction (see paragraph 145).
- 122 This decision to retain the filter drain was questioned by Carillion’s site agent who responded the same day:
- ‘Can you please ask your drainage engineer to explain why this is required? I cannot see what water will be collected by this drain and it will make it much more difficult (and expensive) to install, and it seems to be acting as a carrier pipe for the upper slope drainage anyway?’*
- 123 The Arup team reviewed their decision and identified a discrepancy between contour information on the drawings being used for construction and the appearance of the site based on a photograph of the site. The lead engineer responded:
- ‘We have looked at this again as requested. We need to ensure minimal water reaches the cutting face from the slope above. By adopting the carrier pipe, we will be relying on the topography to divert away the water to the north of CP16...’*
- Our long section is based on a topo survey carried out by yourselves last year is not accurate in this area...To resolve these issue [sic], we suggest you carry out a simple level survey of the points shown on the attached Fig 1.’*

<sup>13</sup> Filter and carrier drain are described at paragraph 96.

124 Although any subsequent actions concerning the above-mentioned survey remain unclear, RAIB has found no evidence to confirm that it was ever conducted. On 5 May 2011, Carillion proposed an alternative arrangement for the slope involving the reinstatement of CP17 and a combination of carrier and filter drains. This proposal was reviewed by Arup and accepted on 9 May 2011, but was not raised or recorded by Carillion through the TQ process and was not constructed for reasons explained at paragraph 128.

### Drain installation

125 In early May 2011, the lowest part of the drain was installed. This included the outlet, the pipe between the outlet and CP19, and pipework from CP19 to approximately the railway boundary (figure 32). Although the pipework passed through the as-designed position of CP18, this catchpit was not constructed. This section was located close to the railway, and both excavation and installation work were undertaken during overnight railway *possessions*.

126 The remainder of the drain was to be constructed on the landowner's side of the boundary fence, and it became necessary to pause drain construction until the necessary legal arrangements between Network Rail and the landowner were in place. The legal arrangements for construction and maintenance of the drain on a strip of land alongside the boundary fence were set out in a servitude (a legal document) dated 6 August 2012.

127 In August 2012, Network Rail informed Carillion that the necessary legal arrangements were in place. Carillion updated its work package plan document for the completion of the drainage works, a task which was expected to take five weeks, and planned for all work to be undertaken outside the railway boundary. A largely new site team was appointed as the original team had dispersed after work on the project was paused. The only member of the original team to return was the site foreman.

128 On 4 October 2012, Carillion's new site engineer contacted Arup to ask for copies of TQs which he (wrongly) understood had not been responded to. It is not clear why these documents were not available to him from Carillion's records. The following day, Arup responded providing copies of the TQs and the unfulfilled request for additional survey data (paragraph 124). These included TQ19 omitting CP17 (paragraph 118). Details of Carillion's alternative proposal dated 5 May 2011 were not provided as the proposal had not been submitted as part of a formal TQ.

129 The remainder of the drain was installed in October and November 2012 and involved extending the pipe already installed from CP19, through the as-designed location of CP18, to approximately the railway boundary. The work in 2012 comprised construction of CP18 (outside the railway boundary), seven further catchpits, around 350 metres of pipework and an inspection chamber linked to a new inlet structure capturing water from the burn near the south end of the drain. The drain was installed within a three-metre-wide strip of land alongside, and outside, the railway boundary. A second fence was installed parallel to the existing boundary fence to enclose the strip of land (figure 45). Excepting the provision of TQ responses, Arup was not involved during this phase of the project.

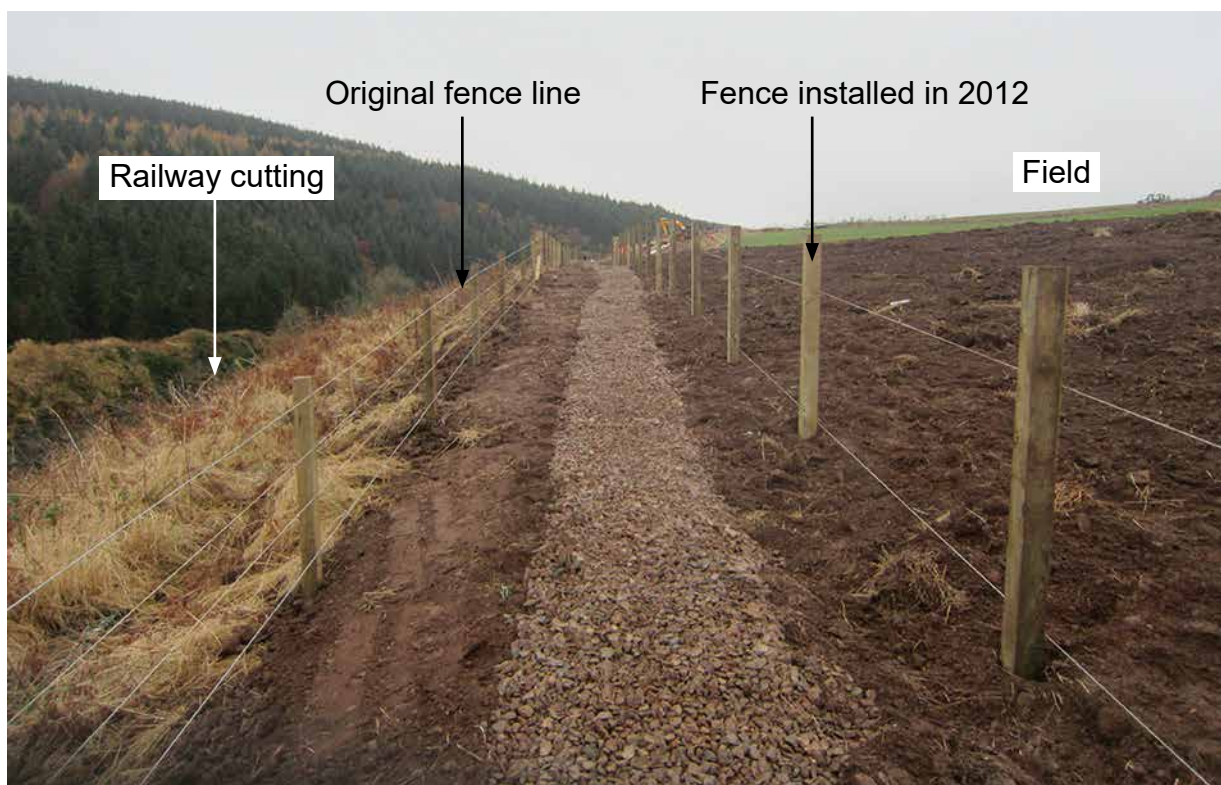

Figure 45: Drain shortly after completion in late 2012 showing section between CP11 and CP16 looking south (Network Rail)

### Changes to the designer's requirements

#### Construction of a bund

130 There is strong evidence that a bund, which diverted flows towards the 2011/12 drain and so initiated the washout 7 metres upslope of CP18, was a feature constructed at about the time that the drain was completed (figures 34, 35 and 36). Evidence that the feature is artificial is provided by its relatively uniform cross-section, its linear alignment over a length of about 20 metres, and by construction debris (wire and small pieces of geotextile) found embedded in the bund.

131 The bund is not shown on the detailed survey undertaken in May 2010 after removal of gorse from this area and is not shown on any Arup drawing. The words used by Carillion to describe surface water flow in TQ20 are inconsistent with the presence of a bund when TQ20 was drafted (paragraph 122). The bund crossed an area used as a route for excavators and other machines moving up and down the slope, as shown by a satellite photograph of the site in late April 2011 (figure 46). A bund crossing this route would have made use of the route difficult and possibly unsafe.

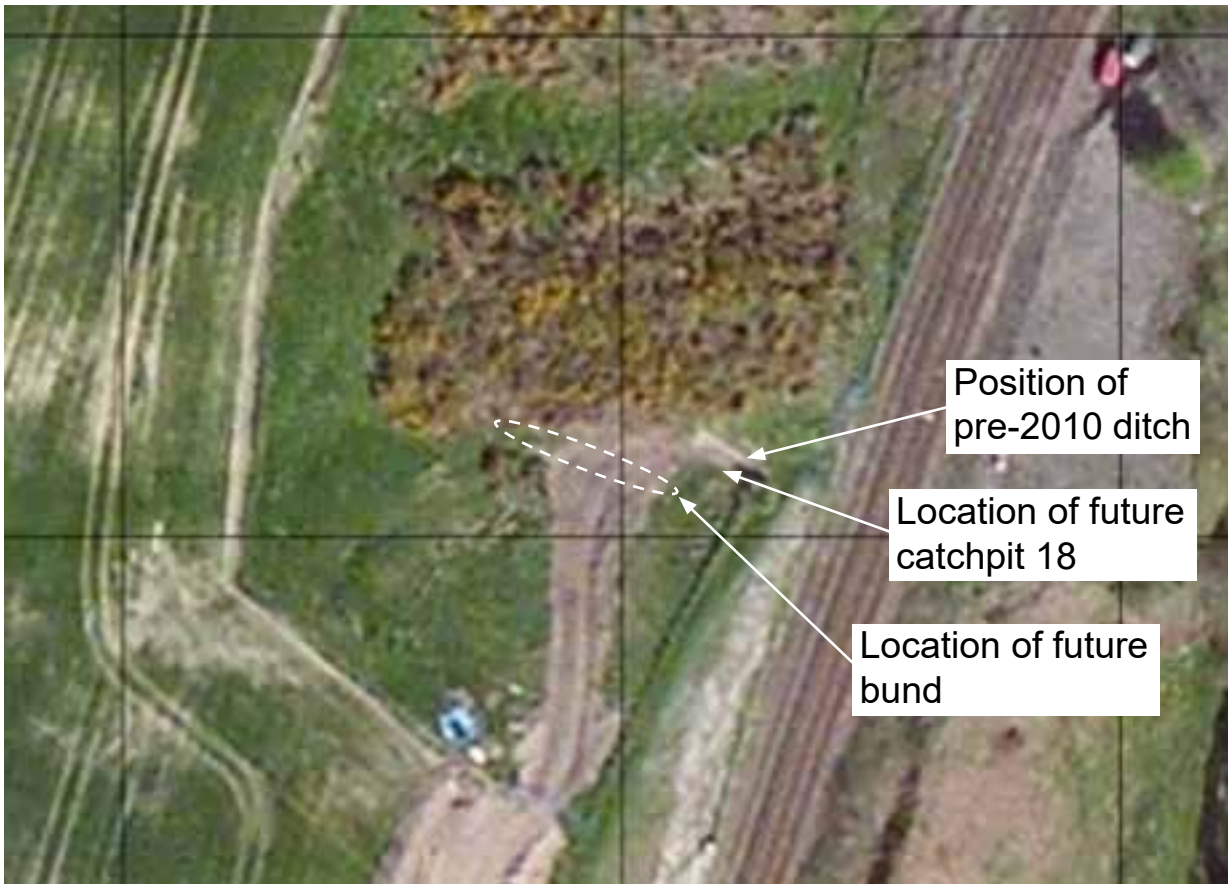

Figure 46: Satellite image April 2011 (Network Rail/ESRI Wayback imagery)



Figure 47: Satellite image April 2014 (Network Rail/ESRI Wayback imagery)

- 132 The bund is visible in a satellite photograph of the same area in April 2014 (figure 47). The larger, thus likely to be the older, gorse growing from the bund was found to contain 'tree' rings indicating approximately seven years' growth (that is, growing since around 2013). There is no evidence of any construction work in the area of the bund after completion of Carillion's drainage work.
- 133 There is no evidence to explain why the bund was built, and no records of any formal or informal approval for its construction. The practical effect of the bund was to constrain most water entering the funnel, so it flowed along gully 1 and reached the 2011/12 drain about 7 metres upslope of CP18. For moderate flows, this water would seep into the 2011/12 drain gravel, flowing downslope over the surface of the gravel if the amount of water exceeded the amount of water which could seep into the drain at the point where the water reached the gravel.

### Connection of existing funnel drainage into catchpit 18

- 134 The design drawings show CP18 located 5.75 metres upslope of CP19, positioned in the natural channel formed by the funnel feature and within the railway boundary (paragraph 95, figure 32 detail A). This proposed location was on the alignment of a series of existing 225 mm (9 inch) diameter clay pipes, separated by short gaps, which had been laid to take water from the pre-2010 ditch, beneath the railway boundary and then into the railway drainage system at the edge of the track. These features were recorded by the May 2010 topographic survey (figure 33) and in photographs taken by Arup during a site visit in June 2010 (figure 48).
- 135 Drawings issued to Carillion by Arup for use in construction included drawing 002/001 issue 04 'Drainage layout' and 002/008 issue 02 'Inlet and Outlet plans'. The pre-2010 ditch (figure 33) is not shown on the drawings issued for construction, but there is no indication that any construction work was intended to disrupt this ditch.
- 136 Drawing 002/001 included the note 'Existing pipe from the field to be connected into CP18' with an arrow pointing towards CP18. The note 'Existing pipe to be concreted into new catchpit' was included alongside CP18 on drawing 002/008. Alongside CP18, drawing 002/004 issue 02 'Inlet and outlet long sections' states '*Existing 2 No. 225 mm dia pipes to be connected into new catchpit*'. It appears one of these pipes was the historical crest drain running parallel to the 2011/12 drain and on the railway side of it (appendix G and figure 32). The second is the pipe leading from the pre-2010 ditch at the bottom of the funnel feature. Witness evidence confirms that the designer's intention was to capture whatever water flowed down the pre-2010 ditch and the associated pipe system and feed it into the new drainage system at CP18.



Figure 48: Pipes entering channel in pre-2010 drainage system at as-designed position of CP18 (Arup, June 2010). Inferred that left-hand pipe is from historic crest drain and right-hand pipe from pre-2010 drainage ditch as shown on figure 32



- 137 Examination of the site after the accident found no evidence of pipes intended to connect the pre-2010 ditch to CP18. Inspection of CP18 showed there was no hole suitable for the connections of this pipework. The only holes in the shaft of CP18 were near its base and provided the inlet and outlet for the 450 mm diameter perforated pipework. No records have been located showing a formal or informal approval for omission of these pipe connections. The clay pipe leading from the pre-2010 ditch was disturbed, and mostly removed, when the section of 2011/12 drain was installed on a similar alignment in May 2011. Witness evidence suggests that an existing pipe was found after the work restarted in October 2012 but, at that time, it was not connected to anything.
- 138 Protection or reinstatement of the pre-2010 ditch with a connection to the 2011/12 drain is very unlikely to have prevented the accident on 12 August 2020 because the bund diverted most surface water away from this area and towards the 2011/12 drain. In order to establish the significance of both omitting to protect or reinstate the pre-2010 ditch and omitting to provide a connection to the 2011/12 drain, RAIB has considered what would have happened if the bund was not constructed, and the ground surface in the funnel was reinstated after construction to its pre-2010 profile. This assumes the ditch and pipe had been maintained so as to be in reasonable condition in 2020.
- 139 In this hypothetical scenario, most surface water in the funnel would have flowed into the bottom of this feature. There would have been no large water flows over the 2011/12 drain upslope of CP18 and so no washout upslope of CP18. If the pre-2010 ditch was connected to CP18 with the original pipe (or an equivalent provided), it is likely that all of the flow reaching the bottom of the funnel would have passed through the pipe into CP18 and there would have been no washout. In the absence of a connection to CP18, water from the bottom of the funnel feature would have flowed over the ground surface and reached the 2011/12 drain just downslope of CP18 (at the location of gully 2). This would have washed out the section of drain downslope of CP18.
- 140 Post-accident surveys showed about 10 m<sup>3</sup> of material was washed out from upslope of CP18 and 13 m<sup>3</sup> from around the catchpit and downslope of it. In the hypothetical scenario of no bund and no connection from the funnel bottom into CP18, the washout volume, and therefore the depth of debris over the rails, would have been significantly reduced. This would have reduced the likelihood of the left-hand leading wheel lifting onto the railhead and into derailment (paragraph 75).

### Relocating catchpit 18

- 141 CP18 was constructed about 7 metres from the position shown on Arup drawings (for example 002/005 issue 03 'Drainage long section'). No formal or informal design change documentation has been located (see paragraph 156). The site engineer responsible for marking the position of CP18 stated that he selected the as-constructed position because the as-designed position was incompatible with omitting CP17 in accordance with TQ19 (paragraph 118) and complying with note 22 on Arup drawing 002/001. RAIB notes that good practice requires pipes to be laid in straight lines between catchpits and a straight line from CP16 to the as-designed position of CP18 would be within 2 metres of the cutting crest (figure 32). Note 22 on Arup drawing 002/001 stated '*To ensure that the crest of the cutting is maintained as far as reasonably practical a 2.0m offset from the crest of the cutting should be maintained where space permits*'.

- 142 The site engineer therefore considered it reasonable to infer that approval of TQ19 was also an agreement to relocate CP18 and that this relocation would then be communicated to the designer through a survey of the as-built work. The site engineer stated that, until after the accident in August 2020, he believed that the as-built position of CP18 coincided with the point at which the pipe alignment turned towards the railway, a turn actually made at the pipe bend a short distance downslope of CP18.
- 143 Arup drawings refer to two intended connections into CP18, one of which was from the pipe connected to the pre-2010 ditch and the other is likely to have been from the pipe forming the historic crest drain (paragraph 136). Neither connection was made into CP18, or into any other part of the 2011/12 drain. The site engineer responsible for CP18 stated this was because he did not identify any existing pipes to be connected and that he was using the Arup construction drawings which, excepting notes requiring connections to be made, gave no details of the pre-2010 ditch/pipe or of the historic crest drain. The note describing the connection from the pre-2010 ditch referred to '*pipe from the field*' which he took to mean a long pipe from the field above the funnel feature rather than the short length of pipe intended by Arup.
- 144 Photographs taken during construction work and witness evidence indicate that, when CP18 was constructed, there was no evidence of the pre-2010 ditch and no evidence of a functioning drain pipe associated with it. After the accident, the end of the historic crest drain was found embedded in fill material, a short distance from the as-designed position of CP18. This was within the railway boundary, so outside the area in which work was planned to be undertaken in 2012 (paragraph 129, appendix G).

#### Lack of geotextile lining to trench

- 145 Arup's design for the 2011/12 drain required a geotextile to be placed on the upslope (field) side and near the top of the gravel. This is a sheet with very small holes which allows water, but not fine soil particles, to pass through it. This was intended to prevent fine particles in surface runoff water from being washed into the spaces between the gravel where they would impede water flow to the pipe. An impermeable membrane was specified on the downslope (railway) side and lower part of the trench, to prevent water seeping out of the drain and into the adjacent cutting slope where it could cause instability. The geotextile and the impermeable membrane are shown on Arup drawing 002/002 issue 04 'Drains and Pits' and in a photograph taken during construction at a location between the south end of the 2011/12 drain and CP16 (figures 49 and 50).

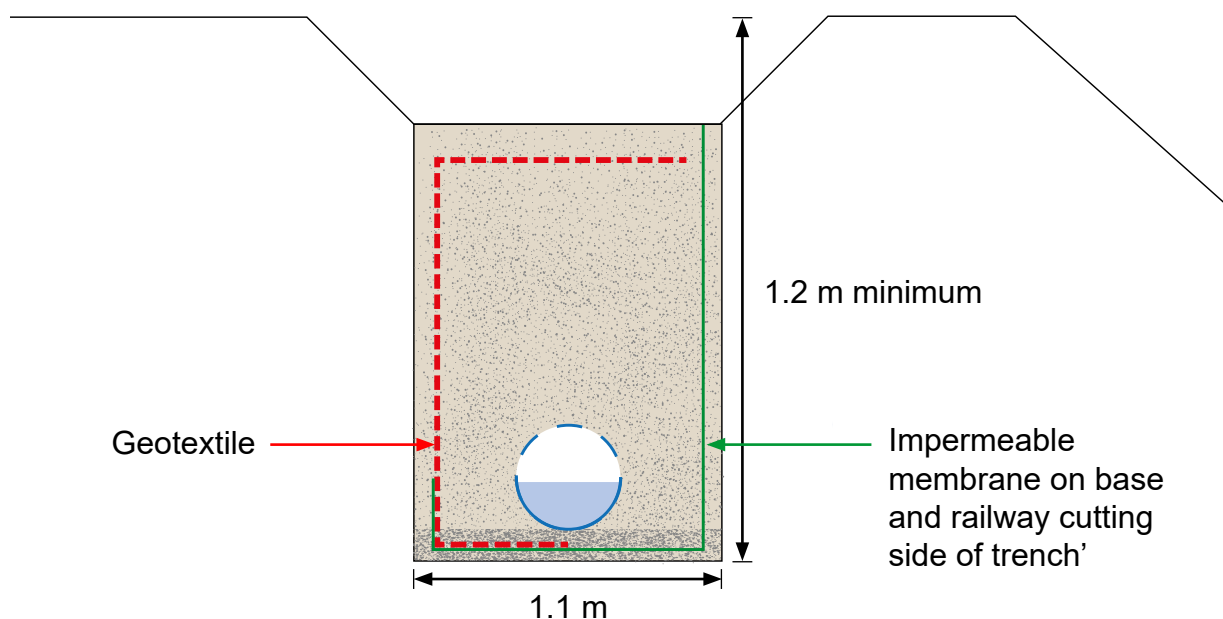

Figure 49: Drain as shown on Arup drawings (simplified from Arup drawing 002/002)

- 146 The geotextile was omitted in the area of the washout, as shown by post-accident excavation of the drain immediately upslope of the washout (figure 8), and by the absence of any geotextile within the erosion scar upslope of CP18 (although not a factor in the accident, the impermeable membrane was also omitted). These areas of drain were constructed in October or November 2012. Geotextile was visible in part of the length between CP18 (as-built) and CP19, in and near the section constructed in May 2011.
- 147 RAIB has considered whether the provision of geotextile in the area of the washout would have significantly affected the washout of gravel. It would have had little effect while the thin layer of gravel placed above the horizontal part of the geotextile was washed out. The geotextile would then still have been restrained along the edge furthest from the railway, where it continued down the side of the trench. It is therefore likely that inclusion of the geotextile would have impeded washout of the gravel. As this effect cannot be quantified, it is uncertain whether it would have had a significant effect on the amount or distribution of debris washed onto the track.
- 148 The absence of the geotextile would have allowed fine soil particles to enter the gravel during the years between construction and the accident, a possible explanation for the proportion of fine particles exceeding the amount specified by the designer (paragraph 25). The finer particles would have impeded the flow of water from the ground surface to the pipe, and so increased the amount of water flowing over the surface of the drain and thus increased the likelihood of a washout. However, even if water flow was not impeded by the fine particles, the gravel and pipe perforations would not have had the capacity to transport the amount of water likely to have arrived at the drain from gully 1 on 12 August, and it is very likely that the washout would still have occurred.



Figure 50: Drain under construction in late 2012 showing section between CP11 and CP16 looking north (Network Rail)

### Site-cut holes in catchpits

149 The inlet and outlet holes to some catchpits were not in accordance with Arup drawing 002/002 'Drainage details sheet 1 of 5' which included a note stating: *'All pipe and pipe/manhole joints to be sealed and made secure. Inlet / Outlet holes in plastic manhole to be pre-formed.'* There is evidence that circular holes had been pre-cut in the catchpit sides to accommodate the inlet and outlet pipes, a method used by suppliers of drainage materials to provide a connection for systems which are not required to be sealed. Such holes typically include only a small gap of about 5 mm around the pipe to minimise the escape of water and prevent gravel from entering the catchpit. There is evidence of pre-cut holes in catchpits 16 and 18 being enlarged by cutting on site (figure 51).

150 At CP18, the enlarged hole on the downslope side of the catchpit was significantly bigger than required to accommodate the drainage pipe. AECOM's analysis concluded that, until surface water flow caused washout of the gravel, escape of water through the gap between the pipe and the enlarged hole would have been constrained by gravel restricting the amount of outflow and by the damming effect of the locally dug fill (figure 30). This would have led to a build-up of water in the gravel sufficient to force the escaping water to re-enter the pipe through the pipe perforations, with no water escaping to the surface. This would not have caused a washout, although it had the potential to trigger a washout if surface water flows over the drain were just less than needed to cause a washout. The washout upslope of CP18 demonstrates that surface flows were sufficient to cause a washout without the assistance of water escaping from around the drainage pipe.

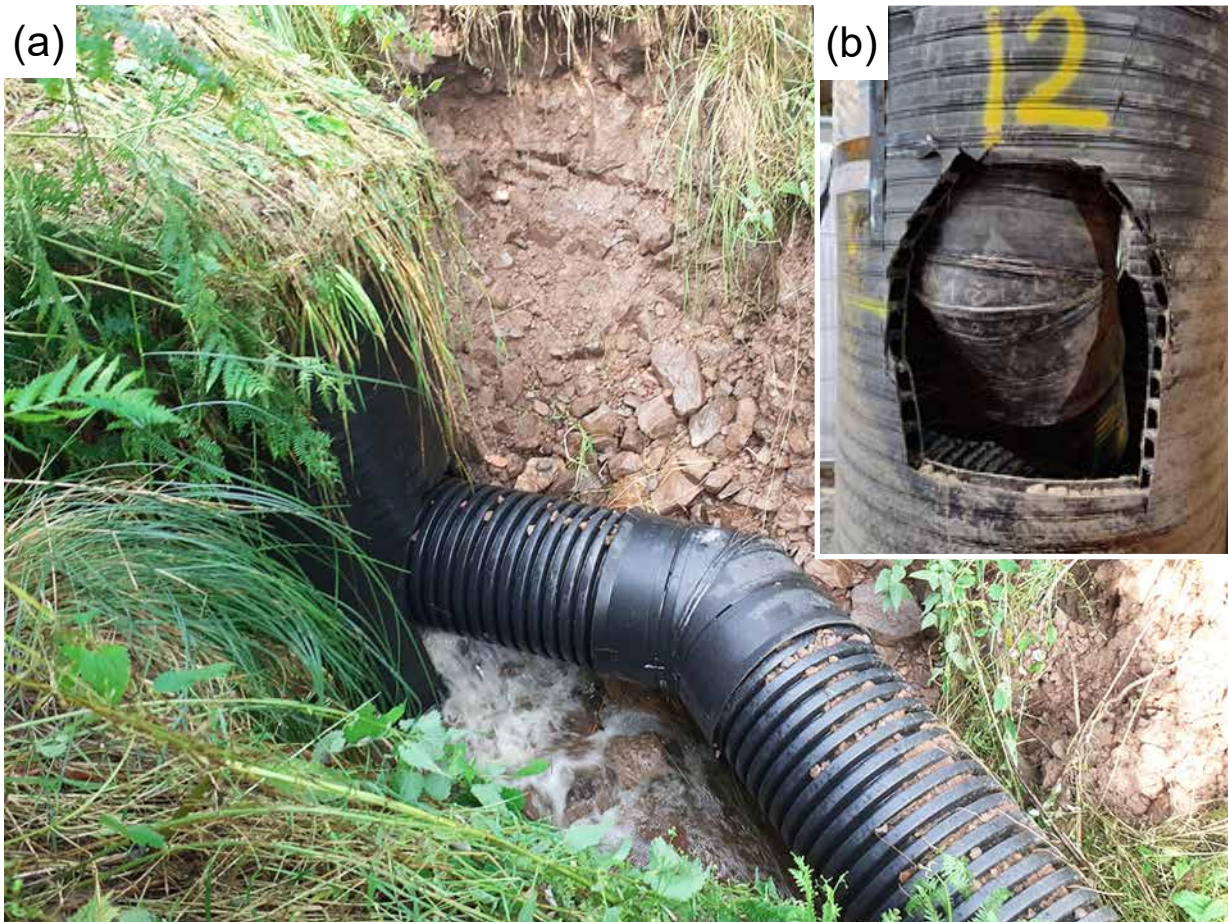

Figure 51: Downstream face of CP18 showing enlarged hole (a) on 12 August 2020, and (b) after removal (Note: a loose section of pipe has been subsequently placed inside the catchpit)

151 After gravel was washed out from the downslope side of CP18, there would have been no gravel to restrict the rate at which water was escaping through the gap between the pipe and the enlarged hole. It is likely that the amount of water then escaping would have influenced the distribution of debris downslope of CP18 (see appendix H). It was not practical to model the effect on debris distribution with the confidence needed to determine the likelihood of this affecting the accident.

#### Locally dug fill upslope of CP19

152 The locally dug material used to backfill the trench for a short distance upslope of CP19 was not in accordance with Arup drawings which required gravel fill in this area (figure 30). The locally dug material was less permeable than the gravel and formed a 'dam' which meant water entering the gravel drain upslope of this, including any surface water and any water escaping through the site-cut holes in CP18, would build up in the gravel upslope of the dam if the inflow exceeded the flow into the perforated pipe in this area. This build-up would reduce the gravel's resistance to washout. Analysis by AECOM showed that the dam effect alone was insufficient to cause a washout. The washout upslope of CP18, in an area where the dam would have little effect on water flows, demonstrates that the washout downslope of CP18 was likely to have happened without the damming effect.

### Bend in pipe

153 A sharp bend was installed about one metre downslope of CP18 (figure 39). This was a consequence of moving this catchpit away from the bottom of the funnel feature, the alignment on which the pipe from CP19 had been laid in May 2011. This was not good practice as pipes are normally installed in straight runs between catchpits to facilitate inspection and maintenance. However, analysis by AECOM has shown that the bend had little effect on drain capacity and so did not affect the accident.

### As-built condition of the drainage pipe

154 A post-accident survey of the drain using in-pipe CCTV equipment identified a section of pipe between CP18 and CP19 which had been installed at an angle, so its perforations were on the side rather than the upper part of the pipe. This would have allowed water to escape from the pipe into the surrounding gravel when the pipe was only 20% full instead of 50% full if the perforations were correctly aligned. However, the same perforations would also allow water to enter the pipe more easily. AECOM concluded that the misalignment had minimal impact on the performance of the pipework. The survey also identified pipes with alignment deflections and displaced joints. While this demonstrates a deviation from good construction practice,<sup>14</sup> AECOM also concluded that the steep gradient of the pipe meant that the deflections had no significant impact on the pipe's ability to carry water on 12 August 2020.

### Control of construction changes

- 155 The contractual arrangements between Network Rail and Carillion meant that Carillion was responsible for the delivery of works in accordance with designs prepared by Arup and approved by Network Rail, together with amendments agreed through formal processes during the construction phase of the scheme.
- 156 No evidence of the decision-making that led to the construction of the bund has been found. Furthermore, there is no evidence that changes such as construction of the bund, moving CP18 from its as-designed position, and/or omission of the connections to CP18 were dealt with as part of a formal design change process. Changes of this type should have been referred to Arup (as the designer) through the technical query process. It is possible that this would have resulted in Arup identifying, and resolving, the mismatch between its design and the circumstances on site.
- 157 When the first phase of drain construction was completed in May 2011 (paragraph 125), new drain pipes had been laid from CP19 to near the railway boundary, passing through the as-designed position of CP18 without this being constructed. The updated work package plan covering the second phase (paragraph 129) was prepared by the site engineer responsible for the first phase of the work. It only covered work outside the railway boundary, and so was incompatible with constructing CP18 in the as-designed position. There is no evidence of any instruction regarding the position of CP18 being given to the site engineer for the second phase of the works. He therefore selected the position, and made decisions concerning connections to this catchpit, based on his own assessment of site requirements (paragraph 141).

---

<sup>14</sup> BS 8000-14:1989 'Workmanship on building sites. Code of practice for below ground drainage'.

- 158 The original Carillion site agent (site manager) ceased to be involved from the middle of 2012. From this time onward a site agent on a nearby site had been asked to oversee the work. His involvement was limited on the basis that the work was considered to be within the competence of the site foreman and the second phase site engineer. Although both the first and second phase site engineers were aware of requirements relating to technical queries, Arup's records indicate that no queries were made for the alterations to CP18, or other changes described in paragraphs 130 to 153. Arup was not actively involved with the project when the second phase of the 2011/12 drain was constructed.
- 159 Network Rail's role in assurance at the Carmont site, and its broader role relating to assurance of Carillion's activities, are covered in paragraphs 160 to 184.

#### Network Rail's role during construction of the drain

**160 Network Rail's project team were probably unaware that the 2011/12 drain was significantly different from that intended by the designer and therefore did not take action. Had the team been aware of this, it is possible that the consequent risk would have been recognised and remedial actions taken.**

- 161 The construction work at Carmont was undertaken in accordance with a 'design-and-build' arrangement within a framework contract between Network Rail and Carillion. Such contractual arrangements are not unusual in the UK construction industry. Network Rail and Carillion were delivering a large number of concurrent projects via the framework. Under this arrangement, Carillion was responsible for both the design and safe delivery of site works, including ensuring the works were delivered in accordance with the designer's requirements. It was also responsible for the performance of Arup as its design sub-contractor.
- 162 Network Rail's Health & Safety Management System<sup>15</sup> (HSMS) refers to the following documents:
- NR/L2/INI/02009<sup>16</sup> describes the processes and roles and responsibilities of staff responsible for the management of the technical and engineering requirements of projects.
  - NR/L2/MTC/088<sup>17</sup> describes the interface between Network Rail's maintenance organisation and the project team, including the contractor. Standard NR/L2/MTC/088 references NR/L3/MTC/089<sup>18</sup> which describes a structured process to enable the maintenance of new and changed assets, and includes a series of asset management forms (prefixed AMP) to be completed at various stages of a project.
- 163 The processes define Network Rail staff roles during a project, including:
- A project manager: appointed by Network Rail for any project involving an external project contract.

<sup>15</sup> Health & Safety Management System, Version 2.6, issued November 2009.

<sup>16</sup> NR/L2/INI/02009 issue 4 published December 2009, 'Engineering management for projects' (issue 4 was applicable to the project, version 5 (June 2011) is dated after the cut-off date for new versions to be applied on the Carmont project).

<sup>17</sup> NR/L2/MTC/088 issue 4 published June 2009: 'Maintenance of new and changed assets'.

<sup>18</sup> NR/L3/EBM/089 issue 1 published June 2009: 'Asset management plan'.

- A 'designated project engineer' (DPE): a person appointed by Network Rail accountable for the co-ordination and integration of technical and engineering aspects of a project.
  - Inputs from the relevant asset engineer and maintenance managers (the latter via an 'interface coordinator' appointed by the maintenance team in accordance with standard NR/L3/EBM/089).
- 164 A Network Rail team, led by a project manager, oversaw delivery of the work covered by the framework agreement. They and the Carillion staff involved with delivering projects under the framework agreement were co-located in an office at Bishopbriggs near Glasgow.
- 165 At the start of a project, the project manager was required to agree a schedule of the deliverables with the asset engineer (Form AMP008). These were the items, including asset details, required to enable the works to be completed and maintained in operational use. The project manager was also required to arrange a pre-work dilapidation survey involving the maintainer and asset engineer to record existing site conditions (Form AMP010).
- 166 When all core work was completed, the project manager was required to issue a construction completion certificate (Form AMP014). The project manager, through the maintenance team's interface coordinator (the person who acted as liaison between the project team and maintenance team), was required to arrange a joint site walkout with the asset engineer to complete the 'taking over' certificate (Form AMP015). Finally, following the rectification of any defects found during this process, the project manager was required to issue a 'final certificate' to the interface coordinator.
- 167 Form AMP010 was completed following a pre-work survey on 15 December 2009, but no other AMP series forms relating to this project have been located by Network Rail.
- 168 The arrangements for the engineering management of projects specified in standard NR/L2/INI/02009 required Network Rail's DPE, in conjunction with the project manager, to determine the nature, extent and competence of persons required to carry out monitoring of the implementation of the project for compliance with the design and other specified technical requirements. This was to allow the DPE to confirm that construction issues emerging during the implementation phase did not invalidate the design and/or the associated risk control measures. However, since Carmont was a design-and-build contract, the DPE's involvement is likely to have been limited to identification of competent Network Rail resources, reviewing staff nominated for key engineering positions and ensuring the design assurance process was completed.
- 169 Although there was no stated requirement for the DPEs to personally inspect the works during construction, they were tasked by standard NR/L2/INI/02009 to formally 'accept' the construction on behalf of Network Rail. The standard allowed for this 'acceptance' to be based on a sample review of a submission made by the construction team, and confirmation that proper quality assurance processes were in place. No such submissions, or evidence of formal acceptance of design changes, have been found by RAIB.



- 170 The Network Rail team also included a construction manager who visited the Carmont site regularly and was also responsible for overseeing other projects ongoing at the same time. Witness evidence shows that his main responsibility was to monitor site safety arrangements and that he also checked the general standard of work, but not the detail of every item. As Network Rail was not responsible for the design, he would not normally be consulted when technical queries were raised or be involved in any design decisions.
- 171 There are no surviving records of the work undertaken, or of any site meetings or discussions held during the second phase of drain construction in October/November 2012. This covers the period when the connections to CP18 were omitted and the bund was formed.
- 172 Unless informed verbally or through correspondence, Network Rail staff would not have been aware of changes made during construction unless evidence was seen during a Network Rail site visit. For example, the geotextile should have been covered by a layer of gravel so its omission would not be apparent after gravel was placed above its intended position. Witness evidence indicates that the construction manager was not present when the steeply sloping section of drain was constructed between CP16 and the railway boundary, and there is no evidence that he was aware of bund construction or omission of the connections to CP18. This level of supervision meant that his site visits did not recognise or report significant deviation from the designer's requirements.

#### Network Rail audits of Carillion

- 173 Network Rail's construction assurance processes were intended to operate in the context of the framework agreement between Network Rail and Carillion which required Carillion to be responsible for self-certifying construction work. Quality and inspection records are not available, possibly as a result of Carillion entering liquidation in 2018.
- 174 Network Rail operated a Principal Contractor Licensing Scheme (PCLS). At the time of the Carmont project, this was governed by standard NR/L3/INI/CP0071<sup>19</sup> which sets out the management system requirements for suppliers applying for a Network Rail principal contractor's licence.
- 175 When an organisation applied for a licence to deliver capital works for Network Rail, an initial audit of their systems and processes was undertaken as part of a licensing scheme known as 'Linkup', before the organisation was granted a provisional licence. After the contractor had completed several projects successfully, Network Rail carried out a further audit to assess both the quality of its work and to ensure that the systems and processes reviewed as part of the first audit were actually being implemented. Provided that the findings of this audit were satisfactory, a full licence was issued. Thereafter, all PCLS licence holders were audited on a regular basis.
- 176 From 2013, Network Rail's principal contractors were licensed by means of the Railway Industry Supplier Qualification Scheme. This scheme includes independent assurance audits to verify that businesses have the capabilities they claim, and the processes to apply their capabilities safely.

---

<sup>19</sup> NR/L3/INI/CP0071 'Principal contractor licensing requirements'. Issue 1 published March 2008 was current when the 2011/12 drain was built.

- 177 Carillion held a PCLS licence between March 2008 and April 2018 and was the principal contractor for the Carmont works. Network Rail has provided evidence of seven audits undertaken at Carillion sites and offices between 2010 and 2015. While all seven identified issues to be addressed, the last three (undertaken in 2014 and 2015) also stated that Carillion's management systems were suitable for it to undertake works as a principal contractor licence holder.
- 178 Before February 2012, principal contractor audits were not carried out at site level; they were management system audits only. Audits of this type would not detect design modifications implemented on site without proper change control, unless found by (and therefore likely to have been corrected by) Carillion's own management processes.

### Project completion

**179 Network Rail's processes that were intended to ensure a managed transfer of safety related information from constructor to infrastructure manager were ineffective. Had this managed transfer taken place in accordance with Network Rail's processes, it is possible that the divergence between the design intent and the asset that had been delivered would have been noted and remedial action taken.**

### As-built drawings and records

- 180 As-built drawings provide information needed for maintenance, modification and removal of assets. They are an essential part of construction activities and are often prepared by the designer. Completion of the as-built drawings by Arup would have provided an opportunity for it to recognise that the works had not been completed in accordance with its design (as adjusted by its responses to TQs). It was therefore an opportunity for Arup to query the changes, specifically the omission of the connections to CP18 and construction of the bund. Despite the following requests from Arup to Carillion in late 2011, witness evidence shows that it did not receive the information needed to complete the as-built drawings:

*'I am conscious that we have not issued as-built drawings to you for the Carmont works. These formed part of the original agreed scope of work. Since my last visit to site in June [2011], I understand Carillion have completed the works. Could you please arrange to provide us with your mark-ups of the AFC drawings so we can update and issue the as-built set.'* (sent by Arup's lead designer to Carillion's site engineer on 4 October 2011 when Arup was unaware the drainage work was incomplete)

*'You will recall we are still waiting for the corrections to the construction drawings so we can issue the final 'As Built' drawings.'* (sent by Arup's design manager to Carillion and copied to its site agent on 20 December 2011).

- 181 Standard NR/L2/INI/02009 required Network Rail's DPE to verify that as-built records accurately reflected the status of the infrastructure to be taken into operational use by Network Rail, and that this could be achieved by undertaking a sample review of the records.

182 Standard NR/L2/INI/02009 also stated, at clause 5:

*‘The PM [project manager] shall not close out any project until all ‘as-built’ records, testing records, spares, health and safety files, asset data, operational and maintenance manuals and all other necessary engineering deliverables have been given to and accepted by the relevant representatives of the Network Rail departments concerned’.*

183 There are no records to confirm if, or how, the checks required by the DPE and Project Manager were undertaken. Furthermore, it is uncertain whether as-built drawings were ever created. Arup’s team was expecting to be asked to do this but did not receive the information (although Carillion could have arranged for them to be completed by its own staff or by another organisation, RAIB found no evidence that it did so). The preparation of as-built drawings would have been an opportunity to spot that the asset had not been constructed as originally designed, and that uncontrolled changes had been made.

184 RAIB also observes that the Construction (Design & Management) Regulations<sup>20</sup> (CDM Regulations) required that a health and safety file (H&S file) be prepared, which should contain all of the information that might be needed for future construction activities involving the new or modified asset. It is generally considered essential to include as-built drawings as part of a H&S file, since they are needed for future construction activities involving the asset, and it is the responsibility of the ‘CDM coordinator’ to ensure that all of the information that is needed is assembled. Although witness evidence suggests the possibility of some associated documentation being provided by Carillion, no trace of the H&S file, or the as-built drawings has been found (see paragraphs 287 to 294). Had such a file been prepared for the drainage works at Carmont, it is possible that the absence of as-built drawings would have been recognised and rectified.

#### Drain erosion before project completion

**185 No action was taken by Network Rail or Carillion when water flow in gully 1 caused slight erosion to the gravel surface of the new drainage trench before the works were completed. This was a missed opportunity to recognise the effect of the bund on water flows and is therefore considered to be a possible causal factor in this accident.**

186 In December 2012, shortly after the drain was completed, but before the associated fencing work was finished, the landowner visited the sloping section of drain following a period of heavy rain. During this visit, he took a photograph of the steeply sloping section of drain upslope of CP18 showing water flowing in gully 1 and slight erosion to the gravel surface of the 2011/12 drain (figure 52). The landowner stated that he passed this evidence to Carillion or Network Rail. No evidence has been found relating to receipt of the image or action being taken in response to it.

<sup>20</sup> The Construction (Design and Management) Regulations 2007, HMSO.



Figure 52: Surface of drain looking towards CP18 and railway in December 2012, before completion of the fencing (landowner)



Figure 53: Surface of drain in light snow looking towards CP18 and railway in March 2013 during an inspection of the completed works (Network Rail). The original image is over-exposed

- 187 A photograph of this area was taken during an inspection of the completed works by Carillion and Network Rail in March 2013. Although the photograph is of poor quality, it indicates that the flow of surface water into the drain was established by the time of this visit (figure 53). Snow cover means the photograph cannot be used to definitively determine whether erosion on the surface of the 2011/12 drain was also still present. However, the limited areas visible on this photograph suggest remedial work had not taken place; there is no evidence of the ground surface disturbance likely to have accompanied any remedial work undertaken in response to the December 2012 photograph.
- 188 It is very unlikely that the slight erosion of the gravel surface would have been immediately recognised as a precursor to a sudden washout affecting railway safety. However, it is clear evidence of a problem requiring action such as repair, monitoring, investigating the source of the water and/or reference to the drain designer (Arup). It is possible that actions such as these would have resulted in provision of safe and effective drainage so avoiding the washout in August 2020.

#### The risk to train operation from summer convective storms

**189 Network Rail did not have suitable arrangements in place to allow timely and effective adoption of additional operational mitigations in case of extreme rainfall which could not be accurately forecast.**

#### Operational management of Scotland's Railway

- 190 Network Rail is responsible for the provision, maintenance, and operation of railway infrastructure such that trains can be operated by other organisations. Network Rail therefore employs asset management teams, infrastructure maintainers and signallers. It also employs route control staff who co-ordinate railway operations and manage variations from timetabled services. In the absence of instructions from route control staff, and provided it appears both safe and practical to do so, railway staff are required to operate timetabled services without seeking explicit authority for their actions.
- 191 ScotRail operates most passenger train services in Scotland, including that involved in the accident. It provides the rolling stock and traincrew required to operate these services, together with managers and control room staff to support these activities. ScotRail operates a railway timetable agreed with Network Rail subject to real-time alterations required to deal with unexpected and/or unusual events.
- 192 An agreement between Network Rail and ScotRail (see paragraph 324) created the 'ScotRail Alliance' to encourage close collaboration. Both Network Rail and ScotRail route control staff are located in the integrated route control centre. Although located together, each party remains responsible for the safety obligations relating to its own activities, so Network Rail remains responsible for the safety of railway infrastructure, including informing others if there is a safety concern.

- 193 Each shift of Network Rail staff is led by an RCM who is responsible for the real-time management of the integrated control. Reporting to the RCM is a team of individuals. On each shift, there are two incident controllers, one for the east of Scotland, one for the west. These incident controllers are directly responsible for the management of reported defects and problems on their respective areas of the railway network. During a typical nightshift, such as that of the night 11 August into 12 August, there are five staff (including the two incident controllers) supporting the RCM. Day and evening shifts had seven staff in addition to the RCM (this was increased to eight shortly after the accident).
- 194 Each shift of the ScotRail control team is headed by a DOM who is supported by a team of train service delivery managers. The RCM and DOM roles both report to the head of integrated control (see paragraph 326).

### Weather-related management processes

- 195 Network Rail's national arrangements for managing operational risk from extreme weather at the time of the accident were set out as a high-level business process in standard NR/L2/OPS/021, 'Weather – managing the operational risks', issue 8, dated June 2019. This required the creation of 'Integrated Weather Management Plans' (IWMPs) giving pre-planned, location-specific responses to adverse and extreme weather. It also described the processes to be adopted when extreme weather was forecast, when it arrived and during recovery from weather-related disruption.
- 196 Information about the content of IWMPs was provided in a suite of documents giving detailed requirements for mitigating the risk of earthwork failure. These included module 8 of standard NR/L3/OPS/021, first published in June 2019 with a compliance date of 7 September 2019. A corresponding document for drainage (Module 12 (Flooding – Drainage Management)) was in preparation at the time of accident and was published on 9 September 2021.
- 197 Module 8 of NR/L3/OPS/021 included the following guidance note in clause 5.4:
- 'At times of significantly heightened rainfall intensity (ie levels well above asset thresholds) increased proportions of the network will become susceptible to failure. Therefore consideration needs to be given to dynamically assessing the risks, regardless of whether there are any cutting slopes or embankments in the documented IWMP for the geographical area under threat.'*
- 198 National operating procedure NR/L3/OPS/045/3.17 (NOP 3.17) with issue 03 dated 6 June 2020 being current when the accident occurred, defined delivery unit (maintenance), asset management and control responsibilities for taking action in response to weather thresholds being reached. Appendix B to this procedure provided these weather thresholds (figure 54). However, at the time of the accident, Network Rail had instructed its weather forecast provider (see paragraph 200) to use a revised set of national alert thresholds. At the time of the accident, appendix B to NOP 3.17 had not been amended to include the revised National Alert Thresholds (figure 55). There is no evidence that this inconsistency was a factor in the accident.

199 These thresholds allowed each weather parameter to be presented using colour codes defined in NR/L2/OPS/21 as follows:

- Green/Normal: the range in which ‘the Rail Industry operates effectively and reliably’
- Yellow/Aware: ‘conditions which have breached the normal threshold however the Rail Industry continues to operate effectively and reliably’
- Amber/Adverse: conditions which, ‘whilst not extreme, are known to be challenging to reliable operations’
- Red/Extreme: conditions which are ‘so severe that consideration has to be given as to the level of service which can be safely operated’.

<b>Weather Hotspot</b>	A weather hotspot is a line-side geographical area that is at a higher risk to one or more weather hazards.
------------------------	---

National Table				
Wind				
Category	Normal	Aware / Level 1	Adverse / Level 2	Extreme / Level 3
Sustained (mph)	29 or less	30 to 39.9	40 to 49.9	50 mph or more
Hourly Gusts (mph)	39 or less	40 to 49.9	50 to 59.9	60 mph or more
Rain				
Category	Normal	Aware / Level 1	Adverse / Level 2	Extreme / Level 3
Hourly (mm)				
3 Hourly (mm)	less than 3mm	3 to 4.9mm	5 to 9.9 mm	10mm or more
12-hour	less than 15mm	15 to 19.9mm	20 to 24.9 mm	25mm or more
12-hour on 100% Wet Soil (mm)	less than 5mm	5 to 7.9 mm	8 to 10 mm	10mm or more
Daily (mm)	less than 30mm	30 to 39.9	40 to 49.9	50 or more
Daily on 100% Wet Soil (mm)	less than 10mm	10 to 14.9 mm	15 to 19.9 mm	20mm or more
15 Daily (mm)	less than 70mm	70 to 99.9 mm	100 to 149.9 mm	150mm or more
Temperature				
Category	Normal	Aware / Level 1	Adverse / Level 2	Extreme / Level 3
Heat ( °C )	less than 20 C	20 to 24.9	25 to 28.9	29 or more
Cold ( °C )	warmer than -0	0 to -2.9	-3 to -7	-7 or colder
Frost ( °C ) (Minimum air temperature - wind >12 mph)	warmer than -0	-0 to -0.9	-1 to -2.9	-3 or colder
1 Day Diurnal Cycle ( °C )	less than 13 C	13 to 15.9	16 to 17.9	18 or more
Snow				
Category	Normal	Aware / Level 1	Adverse / Level 2	Extreme / Level 3
Daily Snowfall (cm)	1.9 or less	2 to 4.9	5 to 14.9	15 or more
Accumulation	TBD	TBD	TBD	TBD
Drifting Risk	None	Low	Medium	High

Figure 54: Weather thresholds (from appendix B of NOP 3.17)

National Table				
<b>Wind</b>				
<b>Category</b>	<b>Normal</b>	<b>Aware / Level 1</b>	<b>Adverse / Level 2</b>	<b>Extreme / Level 3</b>
Mean wind speed (mph)	29 or less	30 to 39.9	40 to 49.9	50 mph or more
Hourly Gusts (mph)	39 or less	40 to 49.9	50 to 59.9	60 mph or more
<b>Rain</b>				
<b>Category</b>	<b>Normal</b>	<b>Aware / Level 1</b>	<b>Adverse / Level 2</b>	<b>Extreme / Level 3</b>
24 Hour Unsaturated (mm)	Less than 20mm	20 to 29.9	30 to 39.9	40 or more
24 Hour Saturated (SMI >1) (mm)	Less than 10mm	10 to 14.9 mm	15 to 19.9 mm	20mm or more
<b>Convective Rainfall Intensity - Available 1st May to 30t</b>				
<b>Category</b>	<b>Normal</b>	<b>Aware / Level 1</b>	<b>Adverse / Level 2</b>	<b>Extreme / Level 3</b>
Precipitation in an hour (mm)	Less than 10	10 - 15	15 - 20	20 or more
<b>Temperature</b>				
<b>Category</b>	<b>Normal</b>	<b>Aware / Level 1</b>	<b>Adverse / Level 2</b>	<b>Extreme / Level 3</b>
Heat (°C)	Less than 20 C	20 to 24.9	25 to 28.9	29 or more
Cold (°C)	Warmer than -0	0 to -2.9	-3 to -7	-7 or colder
Frost (°C) (Minimum air temperature - wind >12 mph)	Warmer than -0	-0 to -0.9	-1 to -2.9	-3 or colder
1 Day Diurnal Cycle (°C)	Less than 13 C	13 to 15.9	16 to 17.9	18 or more
<b>Snow</b>				
<b>Category</b>	<b>Normal</b>	<b>Aware / Level 1</b>	<b>Adverse / Level 2</b>	<b>Extreme / Level 3</b>
Daily Snowfall (cm)	1.9 or less	2 to 4.9	5 to 14.9	15 or more
Drifting Risk	None	Low	Medium	High
<b>Lightning</b>				
<b>Category</b>	<b>Normal</b>	<b>Aware / Level 1</b>	<b>Adverse / Level 2</b>	<b>Extreme / Level 3</b>
Strike Risk	None	Low	Medium	High

Figure 55: Weather thresholds in use by forecast provider at the time of the accident

- 200 Network Rail had established a national contract for a specialist organisation to provide bespoke forecasts structured around the specified weather thresholds and including statements giving a level of confidence in the forecast. Each morning, typically shortly before 03:00 hrs, the provider sent forecasts covering the next five days, starting at 06:00 hrs on the day of the forecast. For Scotland, the forecast was split into five geographic areas: Edinburgh, Motherwell, Glasgow, Perth and Highlands (figure 56 and appendix J). This forecast was sent to a wide distribution list, including RCMs, maintenance delivery units and asset management teams.
- 201 Scotland's Railway developed an 'Adverse & Extreme Weather Plan' (A&EWP) as its equivalent of the IWMP. Issue 8 of the A&EWP, dated 18 January 2020, was current at the time of the accident and, in addition to some other material, included elements of NR/L2/OPS/021, elements of NOP 3.17 and listings of locations for which action was required, and the type of action required, if weather thresholds were exceeded. The locations included earthworks at particular risk of failure due to heavy rain (the 'at risk' list), bridges whose foundations can be undermined by high river flows (scour), areas subject to flooding and details dealing with several other circumstances in which specific types of weather could cause problems. The A&EWP did not mention, and national standards did not require it to mention, the guidance note in NR/L3/OPS/021 module 8 that suggests consideration should be given to mitigation at other locations during significantly heightened rainfall intensity (paragraph 197).



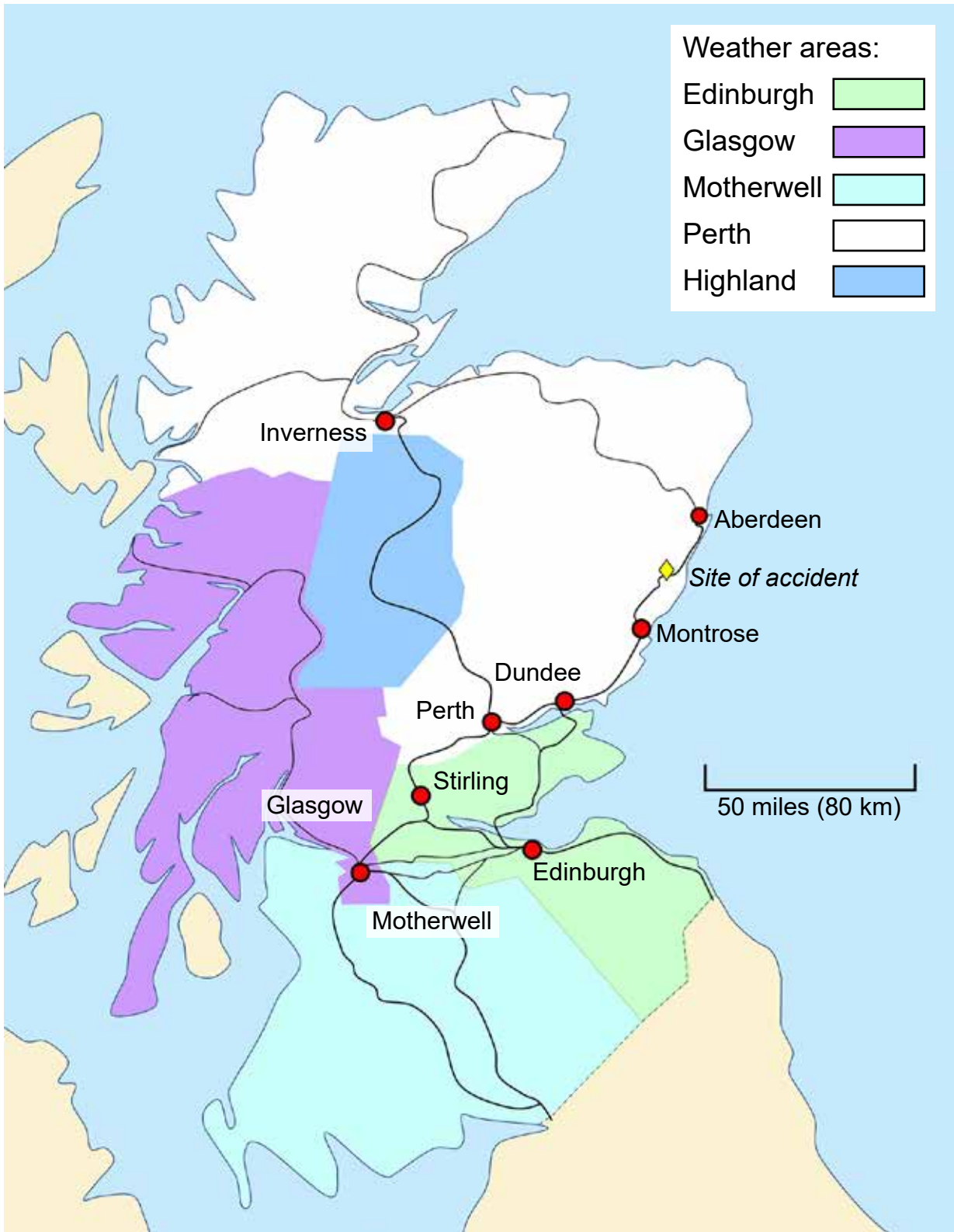

Figure 56: Forecast areas in Scotland

- 202 The locations nearest to the accident site listed in the A&EWP as requiring mitigation for earthwork or flooding risk during extreme rainfall were immediately south of 219 miles 550 yards and immediately north of 223 miles 110 yards, respectively 1.6 miles (2.6 km) and 2.1 miles (3.4 km) from the washout. Since route control had not declared 12 August to be a 'red day' (see paragraph 302) no additional measures (such as periodic inspections) were provided at these locations on that morning.
- 203 Network Rail had no reason to believe the 2011/12 drain was at risk of a washout. It was less than 10 years old and constructed within a regime intended to result in infrastructure compliant with modern standards. It is possible that an inspection of the drain would have identified that it was not performing as expected (see paragraph 275) but, even if this had been recognised, it is uncertain whether the potential for a serious washout would have been appreciated and the earthwork added to the list of sites in the A&EWP. Although the 2011/12 drain was associated with a railway earthwork which was not on the 'at risk' list, it would have benefitted from any general mitigation applied in the area due to the intensity and duration of the rainfall.
- 204 The A&EWP required inputs from various parts of Network Rail, train operating companies and some other organisations, including input from a weather service provided by a specialist organisation. A brief description of the functions most relevant to understanding accident causation is given below.
- 205 When adverse or extreme weather is forecast, or occurs, route control staff are responsible for co-ordinating inputs from other parts of Network Rail, ScotRail, other organisations operating trains in Scotland and specialist contractors. If train services are disrupted by the weather, or by weather-related precautions, route control is responsible for managing the effects on these services.
- 206 Most railway earthworks were constructed before modern earthwork design methods were developed, and the condition of some has deteriorated since construction. Network Rail has undertaken significant amounts of physical work intended to improve the stability of earthworks, but it is not practical to bring all earthworks up to modern design standards, so many earthworks are at greater risk of failure during extreme weather, such as heavy rain, than an earthwork constructed to modern standards.
- 207 As part of their role in safe management of earthworks, Network Rail geotechnical asset management teams are responsible for identifying locations where an earthwork's failure due to extreme weather poses a high risk to the railway, and for identifying the associated mitigation required to achieve acceptable levels of safety during and immediately following such weather. The teams then collate this information on the 'at risk' list which, for Scotland's Railway, was included within the A&EWP (paragraph 201). Before the Carmont accident, mitigation typically involved observing slopes for signs of movement and then stopping trains, or reducing their speed, if there was evidence of significant movement or exceptional water flows.

208 Network Rail's maintenance teams are responsible for routine inspection and maintenance of assets including track, drainage and fencing. They also provide a response to reported defects in these assets. When extreme weather is forecast, maintenance staff are involved in preparations, such as ensuring pumps are available to deal with flooding. Depending on the type of extreme weather, their role during and immediately after this occurs can include observing earthworks on the 'at risk' list, observing river levels at bridges subject to scour, operating pumps and a wide range of other activities.

### Responding to the weather forecast for 12 August 2020 and similar events

209 The process applied by Scotland's route control staff in the days and hours leading up to the accident was broadly consistent with the process described in the A&EWP, but at significant variance with Network Rail national standards for managing extreme weather. Upon receipt of the forecast within control, the RCM was required by the A&EWP to evaluate the forecast and allocate a route alert code. This route alert code was then communicated throughout the organisation. According to the national standards, weather forecasts in the days leading up to the accident, and actual rainfall on the day of the accident, should have resulted in route control staff declaring a 'red' route alert on the day of the accident. This would have led to one or more extreme weather action teleconferences (EWATs) at which weather-related responses from various parts of the rail industry should have been co-ordinated. Although no EWAT was called (see paragraph 226), there is strong evidence that doing so would have had no practical effect on events at Carmont. This is because Scotland Route's EWATs implemented mitigation included in the A&EWP, which did not require rainfall-related mitigation measures in the immediate vicinity of the washout at Carmont (paragraph 201).

210 While no EWAT was called, the risk of severe localised rainfall in parts of Scotland on 11 and 12 August had been recognised on 10 August, although, at this time, the risk of severe rainfall in the Carmont area was not reflected in the detailed area forecasts used by Network Rail (see paragraph 306). This resulted in a structures asset manager sending an email at 15:12 hrs referring to this and the need for maintenance staff to visit bridges at risk of scour. In response to this email, the RAM (Geotechnics) sent an email to route control at 17:50 hrs including the following extracts which refer to the Network Rail Weather Service (NRWS) described at paragraph 219:

*'Please cascade the risk of severe localised rainfall events to all Delivery Units [maintenance teams], noting that all earthworks may be affected at any time over the period. Resource to be arranged as necessary.'*

*Due to unpredictable nature of convective rainfall, maintenance to use local knowledge where possible to 'self-instruct' visits to earthworks sites if concerns are raised from real time feedback of weather conditions.*

*The list of earthworks susceptible to adverse weather is shown in Section W of the Route Adverse & Extreme Weather Plan [A&EWP]...*

*The notes below show current forecast areas of concern however should an intense enough rainfall event occur locally then any earthwork could be affected.*

*Control to make best endeavours to respond to any reports of localised flooding and/or extremely heavy rainfall, in the vicinity of earthworks named in the Route Adverse and Extreme Weather Plan. A cab ride or site inspection is acceptable during daylight hours, a speed restriction in accordance with the Route Adverse and Extreme Weather Plan is acceptable during the hours of darkness, or, in daylight, if resources are not available for cab ride/site inspection.*

*In the first instance the listed earthworks named in the Route Adverse and Extreme Weather plan should be inspected. Geotech RAM team or Geotech On Call can support in identifying other affected earthworks should local information raise concerns...*

*Geotech RAM team to continue to monitor NRWS forecast and provide updates on changes to requirements (on receipt of accurate location/intensity information)...*

*The above approach is in keeping with the Route Adverse and Extreme Weather Plan process. If there is any doubt on mitigating actions please refer to Section W.'*

- 211 Also, in response to the email sent by the structures asset manager at 15:12 hrs on 10 August, an email exchange took place between route control staff later on the same day. This included an email from an RCM at 18:24 hrs referring to an earlier email he had sent at 11:28 hrs on 24 June 2020 when following up a request on 19 June 2020 relating to short-notice inspections of bridges subject to scour. The RCM's June email included the following extracts:

*'I am concerned that the responsibility of identifying the structures being put at risk by localised flooding etc. is being put onto the Incident Controller to do at very short notice.*

*There is only one Incident Controller for the West and one for the East covering the whole of [Scotland]. We are also following Social Distancing guidelines at the moment [a consequence of the 2020/21 Covid-19 pandemic]*

*During disruptive events, our time is consumed by managing the response and dealing with the recovery. With the forecast predicting lightning and significant rainfall, this could leading [sic] to many substantial incidents to deal with.*

*We also have other incidents, not relating to the weather, that could play a factor (fatality / bridge strikes etc.) not to mentions CRT's.<sup>21</sup>*

*I am worried that we will not be able to pinpoint the designated structures in the plan in time, contact the P/Way,<sup>22</sup> arrange the response and co-ordinate these within the necessary timescale at such short notice, especially if we are overwhelmed by other incidents.*

*The benefit of our regular practice in preparing for scour and embankments and cuttings inspections is that we are preparing the maintenance department in advance (normally 24 hrs) to give them time to arrange the resources required within the timescales.'*

<sup>21</sup> CRT is critical rail temperature. This relates to expansion of the steel rails in hot weather, or contraction in cold, and the need to manage risks which arise from this.

<sup>22</sup> The P/Way is a traditional railway term referring to the track and the teams (the Delivery Units) who maintain it.

212 Reviewing these emails shows:

- a) The geotechnical team understood risk could arise at ‘any earthworks’, not just those listed in the A&EWP (RAIB acknowledges the word ‘any’ was probably intended to indicate the impossibility of identifying all vulnerable earthworks rather than a belief that every earthwork was actually vulnerable). This risk was illustrated by the landslips at Ironies Bridge and south of Laurencekirk; neither occurred at locations on the ‘at risk’ list included in the A&EWP (paragraphs 49 and 53). It is also demonstrated by analyses of previous earthworks failures undertaken by Network Rail (see paragraph 400).
- b) The email from the RAM (Geotechnics) refers to application of mitigation at sites not on the ‘at risk’ list. The A&EWP only lists mitigation for ‘at risk’ earthworks, an approach consistent with the requirements of NR/L3/OPS/021 module 8, but which provides no guidance on how risk at other earthworks should be managed.
- c) The A&EWP mentions structured expert judgement as a means of using relevant actual data to adjust responses in the light of events, but does not specifically link this to earthwork mitigation. RAIB has considered whether this would be an appropriate way of identifying and instigating weather-related mitigation for numerous earthworks not included in the ‘at risk’ list but in an area affected by extreme weather. For reasons given in paragraph 213, RAIB concluded that it would not be appropriate unless carried out with the benefit of well-developed contingency planning. No such contingency plans existed before the Carmont accident.
- d) Route control was focussed on providing mitigation at sites listed in the A&EWP, and expressed concern about implementing mitigation beyond this list without specific evidence of a potential or actual problem (for example, an infrastructure failure). This focus is also apparent from witness evidence.
- e) The geotechnical team undertook to identify earthworks not on the ‘at risk’ list but possibly affected by the rainfall, if route control provided sufficient information about concerns in particular localities. Before train 1T08 started its northward journey at 09.30 hrs, route control staff were aware of two landslips and two flooding events within about 17.7 km (11 miles) of the washout. This awareness did not result in any mitigation being applied in response to these known events. It is possible that the absence of a response was influenced by workload in route control (see paragraph 236) and/or in the geotechnical team. Geotechnical assets affected by the extreme rainfall included nine locations with landslips plus earthwork failures due to the canal breach at Polmont.

- f) The geotechnical team had undertaken to monitor the NRWS (see paragraph 219), and was checking it a couple of times a day, or in response to control notifying it of an incident or feedback about a problem. As implied in the 10 August email and confirmed to RAIB in post-accident correspondence, initiating earthwork mitigation required route control staff to inform the geotechnical team of a problem. Responding to such reports would form part of a dynamic risk assessment for geotechnical assets (see paragraph 217), but reliance on this alone meant there was a significant risk of a train encountering a landslip before route control (and therefore before the geotechnical team) was aware of a problem. The NRWS could, if appropriately configured, have been used to determine when the geotechnical team should initiate precautions outside locations on the 'at risk' list. However, Network Rail had not provided the rainfall thresholds at which this should be done and, without these, it was impractical for the geotechnical team to determine appropriate action while dealing with an extreme weather event (see paragraph 213). Such threshold values were introduced after the accident.
- g) Route control staff were concerned about availability of resources, both within control and from the wider Network Rail organisation, to implement weather-related precautions without around 24 hours' notice.
- 213 The use of structured expert judgement during management of extreme weather events is included in the A&EWP (Section K), NR/L2/OPS/021 (Section 11) and NOP 3.17 (Section 10). It is described in the A&EWP as: *'an exercise carried out with appropriate industry members who can provide input to decision making, using actual data captured during extreme weather events to define network limits outside of those defined by existing thresholds'*. Unless based on contingency plans, neither this, nor dynamic risk assessment by geotechnical staff, are appropriate means to determine the type of mitigation and the rainfall thresholds at which it should be applied to earthworks not on the 'at risk' list. No relevant contingency plans were available before the accident at Carmont.
- 214 Contingency planning is needed because establishing appropriate responses needs acquisition of historical earthwork failure data (not necessarily limited to the British rail network) and associated weather records, followed by consideration of these in the context of geotechnical theory and geological context. The technical assessment of this information cannot be done in a few hours (or less) by the relatively small number of staff in a route geotechnical team. It may require specialist technical input not available in this team and will require considerable interaction with other parts of the railway industry, including route control staff, to establish responses that meet the challenge of balancing necessary safety mitigation with disruption to planned services. Structured engineering judgement and dynamic risk assessments will sometimes be needed when deciding how contingency plans should be applied in a particular situation.
- 215 The June email exchange (paragraph 211) continued as further thunderstorms were forecast to occur on 26/27 June. This describes arrangements made for maintenance staff to be deployed both to advise of adverse weather in their locality and to visit bridges at risk of scour if necessary. Also, the staff who would normally operate route control over this period were supplemented by an additional person assigned to a 'weather desk'. No such arrangement, or alternative mitigation better suited to dealing with earthworks, was put in place for earthworks on 12 August.

216 The approach taken by the geotechnical and route control teams was consistent with a corporate statement provided by Network Rail in a response to a post-accident RAIB request for information about interaction between geotechnical and control staff in the years leading to the accident. This statement acknowledges that geotechnical engineers in Network Rail have always been aware that short duration high intensity rainfall (sometimes the result of convective rainfall) presents a risk to earthworks not on 'at risk' lists and includes the following extracts (RAIB paragraph lettering):

- a) *'Any procedure relating to convectional rainfall has to rely in large part on real-time local intelligence given the absence of reliable forecast data.'*
- b) *'Since at least in or around 2016 there has been a developing awareness, both within Network Rail and within the wider geotechnical scientific community, that convectional rainfall events also create an increased likelihood of a landslip.'*
- c) *'Work on rainfall thresholds had been commissioned by Network Rail centrally and was frequently discussed [among Network Rail geotechnical staff] from in or around 2016.'*
- d) *'[Network Rail geotechnical engineers] were aware...that the Adverse and Extreme weather Plan ("the AEW") only set out the procedures for implementing mitigations at the locations listed in the AEW. Such an approach was considered to be a reasonable and proportionate way to manage the rail network during periods of extreme weather, including rainfall.'*
- e) *In the context of Scotland's Railway: 'From 2019 onwards there was a growing perception that we were experiencing an increase in the number of convectional rainfall events in Scotland. The discussions between Control and [Scotland geotechnical staff] from 2019 onwards were Network Rail's way of recognising both the increase in convectional rainfall events and the difficulty in accurately predicting those events.'*
- f) *In the context of Network Rail's centrally based geotechnical team: 'Awareness of risk associated with intense storms which cannot be reliably forecast developed particularly following the derailment at Watford [in September 2016] when [North West and Central] NW&C Region (previously [London North Western] LNW Route) started to implement a broader approach to mitigating speeds [speed restrictions] over longer sections of network during adverse and extreme rainfall events. This approach went above and beyond the mitigation measures required under the Standards (which evolved from a previous ORR Improvement notice in 2012).'*

217 The Network Rail corporate response refers to NR/L3/OPS/021 module 8 (paragraph 196). Paragraph 5.4(b) of the module is reproduced below with minor grammatical changes (Scotland's A&EWP is, for the purpose of this paragraph, equivalent to an IWMP):

*'In the build up to and during rainfall events of significantly heightened intensity that are forecast to occur in geographical areas where no earthwork assets are documented within the IWMP, appropriate engineering input from the RAM (Geotechnical) team shall be sought to provide a technical view on risk exposure, supported by dynamic risk assessment.'*

- 218 The preceding evidence demonstrates that Network Rail, corporately and in Scotland, understood that intense rainfall posed a risk to earthworks not on the 'at risk' list, but considered that the difficulty of forecasting this with sufficient notice sometimes meant it was not practical to apply mitigations in the areas likely to be affected. This approach could have been considered reasonable before modern technology was capable of providing reliable short-notice forecasts of intense storms and real-time information about actual amounts of rainfall. However, this was no longer the case after 31 August 2015 when Network Rail had procured a system that was capable, if appropriately configured, of providing staff with information in an appropriate format.
- 219 Short-notice forecasts and actual rainfall data had been available through the internet-based NRWS since 31 August 2015 (see paragraph 355) and included the following:
- a) Route-specific, five-day forecasts identifying whether weather thresholds might be breached in each of the five forecast areas applicable to Scotland (thresholds and areas are shown on figures 51 and 52, a sample forecast is included at appendix J).
  - b) Hour-by-hour, location-specific forecasts, including 52 in Scotland, of which 21 are within the 'Perth' weather area and Laurencekirk was the closest to the accident site, being 15.8 km (9.8 miles) from there.
  - c) Real-time weather observation data from 44 locations within Scotland, including 18 in the 'Perth' weather area. The Inverbervie location is closest to the accident site, 13.7 km (8.5 miles) away.
  - d) Alerts which could be set up by users to provide warnings if the real-time observation data reached specified values, for example, if a specified amount of rainfall fell in a given location.
  - e) Data from observation locations supplemented with data from precipitation radar. This provides a good estimate of rainfall in real time for any location in Britain and allows real-time rainfall alerts to be set for any location on the rail network.
  - f) Tools within the NRWS system included the Precipitation Analysis Tool (PAT) which combines the forecast rainfall and the current soil moisture index (a measure of the amount of water in the soil) to give an indication of the amount of water expected in the soil and, as this water increases the risk of slope instability, an indication of landslip risk. Geotechnical asset management staff were responsible for identifying locations selected for this tool. At the time of the accident, locations in Scotland were limited to those on the 'at risk' list in the A&EWP, so the tool was not configured to assist assessment of landslip risk at other locations.
- 220 The NRWS was being referred to by the route asset management teams when the accident occurred at Carmont and was available to route control staff. Although it could have been configured to provide all these staff with information, including alerts, showing that rainfall thresholds associated with intense rainfall had been reached in the Carmont area, this had not been done. In addition, training necessary to use these features had not been delivered.



221 Data obtained after the accident relating to observations at Inverbervie shows that a total of 54.6 mm of rain fell on 12 August, with more than 40 mm having fallen by 07:00 hrs. Rainfall data is only reported from this location at the end of each hour. Table 2 shows the Inverbervie data available from NRWS on the day of the accident and corresponding data for Carmont obtained by the Met Office after the accident using precipitation radar data.

<b>Time</b>	<b>Inverbervie rainfall in preceding hour (mm) from NRWS</b>	<b>Inverbervie total rainfall since midnight (mm) from NRWS</b>	<b>Carmont total rainfall since midnight (mm) from Met Office radar data</b>
05:00 hrs	0.0	0.0	0.0
06:00 hrs	3.00	3.00	0.5
07:00 hrs	41.6	44.6	17.1
08:00 hrs	5.2	49.8	28.1
09:00 hrs	3.6	53.4	51.5
10:00 hrs	1.2	54.6	51.5

Table 2: Met Office rainfall data for Inverbervie and Carmont

222 Data from Inverbervie and from the accident site (table 2) shows rainfall at both locations significantly exceeding the 10 mm in one hour threshold contained in appendix B of NOP 3.17 valid when the accident occurred (paragraph 198, figure 54), and the 20 mm in one hour threshold being used by the weather forecast provider at the time of the accident (paragraph 198, figure 55). The data from both locations also shows rainfall greater than the 40 mm in three hours threshold at which a post-accident amendment (Emergency Change document NR/BS/LI/455 dated 14 September 2020) to NOP 3.17 triggered implementation of intense rainfall mitigation, which included reduced train speeds in the area affected. Knowledge of earthwork risk (paragraphs 216 to 218) and rainfall data available from NRWS were sufficient for this mitigation process to have been applied in the area of the washout on the day of the accident.

223 The June 2020 emails show that the geotechnical asset management team in Scotland identified the risk presented to earthworks not on the 'at risk' list by the intense storms associated with convective summer rainfall. An email from the RAM (Geotechnics) on 25 June 2020 addressed to the Director of Engineering and other Network Rail staff explains that this type of rain is impossible to forecast with sufficient notice and accuracy to allow deployment of mitigation in the manner envisaged by the A&EWP. This is unlike winter (frontal) storms which can be forecast with reasonable confidence 24 to 36 hours in advance.

224 The email recognises that an operational response based on knowledge of actual rainfall is needed, and that this is a much more dynamic approach than that contained in the A&EWP. Extracts from this email, with explanatory material added by RAIB, include the following which appear to be seeking actions comparable to those which Network Rail had described as 'procured' and 'briefed' in 2015 (see paragraph 410):

- a) *'This requires a different way of working to our established weather procedures and we have had a bit of push back from control around their ability to cater for this.'*

- b) *There are medium to long term plans to do things differently through changes to the Network Rail Weather Service. [A member of the asset management staff] has done a great job of exploring options with our provider than [sic] may be able to be implemented in a matter of weeks.*
- c) *These will still need Control to have the ability to respond more agilely and dynamically to weather events than they are currently able to do.*
- d) *The same approach as frontal weather simply isn't appropriate... the fact there is no EWAT but a risk shows it's probably overlooked at the moment.'*

#### Route control staff actions in response to events overnight 11 August into 12 August

**225 Although aware of multiple safety related events caused by heavy rain, route control staff were not required to, and did not, restrict the speed of train 1T08 on its northward journey from Carmont to Stonehaven.**

#### Holistic overview of the weather situation

- 226 Although extreme weather was included in the forecast issued at 02:57 hrs on 11 August, a 'red' route alert code had not been assigned for that day by the RCM; the alert code issued for the period from 06:00 hrs on 11 August to 06:00 hrs on 12 August was 'adverse' (paragraph 209). The reasons for this decision and its implications are discussed at paragraph 298.
- 227 During the night of 11/12 August 2020, the weather had caused multiple failures and other problems on the railway infrastructure throughout Scotland's central belt and eastern areas (paragraph 44). The cumulative effect of these failures was such that by 05:00 hrs, the only major route in the central and eastern parts of the country which remained unaffected was Inverness – Aberdeen – Dundee and, during the very early part of the morning, trains operated over this route without encountering weather-related problems (paragraphs 45 to 48).
- 228 Shortly before 07:00 hrs, route control began to receive information about weather-related issues between Aberdeen and Dundee and, at 07:01 hrs, train 1T08 was brought to a stand due to the landslip near Ironies Bridge south of Carmont signal box (paragraph 47). At 07:18 hrs route control staff instructed the Carmont signaller to make arrangements for train 1T08 to return to Stonehaven. This journey did not start until about 09:30 hrs (paragraph 57).
- 229 By 09:00 hrs, around 30 minutes before the return journey started, four obstructions of the railway within 17.7 km (11 miles) of train 1T08 had been reported to control (figure 16). These were:
- a landslip near Ironies Bridge, affecting the up line, which led to train 1T08 being stopped (paragraph 49)
  - flooding affecting the down line, also close to Ironies Bridge (paragraph 51)
  - flooding at Newtonhill (paragraph 48)
  - a landslip a short distance south of Laurencekirk station (paragraph 53).

230 Although aware of these obstructions on either side of train 1T08, route control staff did not take any action to assess the risk to the operation of 1T08 on its return to Stonehaven and took no action to run the train at a reduced speed. With the exception of Network Rail's stranded train risk assessment process (see paragraph 232), there was no process requiring route control staff to assess risks to specific trains such as 1T08 beyond general situation awareness possessed by individuals within the control function. The resources available to control (see paragraph 236) and the volume of incidents which were being managed meant that such reliance on individual situational awareness did not assure the safety of individual train operations.

231 The apparent lack of awareness about weather-related risk to train 1T08 contrasts with action taken when train 1A43 was reversed at Laurencekirk station because flooding at Newtonhill meant it could not continue its scheduled northward journey. Train 1A43 had arrived at Laurencekirk station at about 07:16 hrs and remained there until, at 08:28 hrs, route control staff instructed the Laurencekirk signaller to return the train to Dundee as train 1Z43 (paragraph 52). When giving this instruction, an informal exchange between route control and the Laurencekirk signaller identified that the train had been at Laurencekirk for over an hour, and led control to instruct the signaller that he should advise the driver of 1Z43 to run at a reduced speed. The instruction was given, but there was no opportunity for the driver to implement it as he stopped the train shortly after leaving the station because he encountered a landslip (paragraph 53).

#### Stranded train risk assessment

232 It is possible that route control staff would have required train 1T08 to travel northwards at reduced speed if they had given further consideration to the associated weather-related risk after instructing the Carmont signaller to return it to Stonehaven.

233 Train 1T08 was stranded from 07:01 hrs to 09:30 hrs, almost two and a half hours. Network Rail procedure NR/L3/OPS/045/4.15 requires a risk assessment for stranded trains and includes guidance that this should be done within 30 minutes of the train becoming stranded, and with further assessments at intervals appropriate to the circumstances.<sup>23</sup> The procedure states that this is a joint responsibility of the Network Rail control and the train operating company control. The Alliance arrangements in Scotland meant that relevant staff from both organisations were located in the same route control.

234 Stranded train risk assessments are intended to assess the welfare of the passengers to determine whether they should be evacuated from the train. In the case of the passengers on train 1T08, their low numbers and the presence of functional toilets, air conditioning and other on-board services meant that, although the prolonged delay south of Carmont signal box was inconvenient, their welfare was not at risk. Furthermore, the rural nature of the road network in this area, combined with considerable disruption to the roads caused by the weather, meant that any evacuation of the passengers to road transport would have been hazardous.

---

<sup>23</sup> 'Managing Stranded Trains and Train Evacuations', issue 1, dated 2/9/2017.

235 A stranded train risk assessment for 1T08 was not carried out. Witness evidence indicates this was an oversight due to the high workload in route control caused by the large number of incidents being managed (paragraphs 44 to 53). The circumstances of train 1T08, and the lack of immediate welfare issues for the passengers, mean that it is improbable that a stranded train risk assessment would have led route control staff to take action relating specifically to passenger welfare needs. However, although not part of the documented process, it is possible, but unlikely, that an assessment in the knowledge of surrounding infrastructure problems would have triggered a decision by route control staff to require movement of train 1T08 at a reduced speed.

#### Resources available for route control staff

236 Route control is routinely resourced (paragraph 196) to deal with the problems likely to arise as a normal consequence of railway operation. Typically, these will include equipment failures, staffing issues, and the problems associated with adverse weather that is normally encountered. This resource can be insufficient to deal with exceptional events. Evidence that route control staff were overloaded on the morning of 12 August 2020 is provided by witness evidence, the number of events listed in appendix D, the severity of some of these events (for example, the canal breach at Polmont) and omission of the stranded risk assessment for train 1T08.

237 It was possible for further resources to be brought into control to deal with abnormal circumstances. One option was an additional member of staff brought on duty to operate a specific 'weather desk'. This individual would provide additional support to other control staff managing weather-related incidents. This relied on a competent individual being available and willing to work overtime. A 'weather desk' had been introduced in response to adverse weather in Scotland in June 2020 (paragraph 215). However, no 'weather desk' was operated on the night of 11/12 August 2020 and there is no evidence suggesting that serious consideration was given to seeking volunteers to staff this.

238 An alternative source of additional resource is the implementation of senior management incident control, commonly referred to as 'gold command', and described in NR/L2/OPS/250, 'Network Rail National Emergency Plan'. This deploys a cadre of senior managers who can be tasked with managing a specific problem or incident (such as an adverse weather event). Although Network Rail procedures describe this implementation as being decided by an EWAT meeting, the RCMs within the Scotland route control sometimes did so without an EWAT meeting.

239 During the night of 11/12 August, the night shift RCM considered implementing the gold command structure to better manage the weather issues. However, despite the level of disruption already known about and the forecast of further extreme weather received at 02:51 hrs, he did not do so because he judged that, by the time the necessary staff had been mobilised, the need for the additional support would have receded. Had a gold command structure been implemented earlier, it is possible that the railway's ability to respond more effectively would have increased.

240 The following morning, before the accident at Carmont occurred, the day shift RCM, in conjunction with the head of integrated control, decided to implement 'gold command' to manage the recovery from the weather issues. However, the time taken to implement this decision meant that this did not become operational until 10:12 hrs, shortly after the accident happened. A second separate command structure was then created to manage the issues related to the accident.

241 It is possible that, had additional resources been available at route control earlier on August 12, consideration of damage elsewhere in Scotland, including the four events in the Laurencekirk/Newtonhill area, would have led to recognition of the potential threat to train 1T08 from the extreme weather in the vicinity of the train. It is possible that this would have led to actions being taken to mitigate that threat.

### Network Rail route control staff competency requirements

242 Network Rail procedure 2.02 provided the process for the competence management of Network Rail staff working in route control.<sup>24</sup> This process contained 14 units, each of which was to be assessed on a three-year rolling programme. An annual 'competency conversation' was also required between each member of staff and their line manager.

243 There is no specific unit dealing with the combined effect of a large number of concurrent weather-related problems. It is not practical for a procedure to deal explicitly with every eventuality which could be encountered in a route control. However, the relevant actions are provided in two units. Unit 2 covers major incidents and includes the following performance criteria:

- *Mobilise response/assistance, calling in specialist response as required*
- *Communicate with key stakeholders and follow reporting processes as appropriate*
- *Implement a prioritised plan to support management of the incident including regular updates to monitor incident through to conclusion.*

244 Unit 10 covers managing adverse weather and refers to:

- *'underpinning knowledge' including*
  - *arrangements in the case of extreme weather and the role of the Extreme Weather Action Team (EWAT<sup>25</sup>)*
  - *the safety risks associated with the different weather conditions*
  - *awareness of the different weather and associated hazard alert levels*
- *performance criteria including*
  - *'You must consistently ensure that you...mobilise resources in accordance with the appropriate weather plan/actions'.*

<sup>24</sup> National Operating Procedure 2.02, issue 3, dated 7/12/19 was applicable at the time of the accident.

<sup>25</sup> EWAT is used in Network Rail documents to mean both extreme weather action team and extreme weather action teleconference.

245 Although the Network Rail route control staff had been assessed in accordance with this competence management system, the risks to the movement of train 1T08 were not considered, the stranded train risk assessment was not completed, additional resources were not sought and the senior management incident command structure was not initiated in a timely manner. Further shortcomings associated with the competency management system are described in paragraphs 314 to 317.

#### The actions of the signaller and driver

**246 The signaller and driver were not required to, and consequently did not, restrict the speed of train 1T08 to below that normally permitted.**

247 It is normal practice on the national rail system to operate trains at the maximum permitted speed where this is practical, safe and in accordance with train operators' professional driving policies. There are some exceptions, such as systems used by some train operators to allow trains to be driven in a way that reduces fuel consumption while still achieving timetable requirements.

248 The railway is an environment in which compliance with rules and procedures is expected as a fundamental part of ensuring safety. Although drivers and signallers are required to take appropriate action if aware of an infrastructure problem, the rules and procedures are based on an underpinning assumption that the infrastructure manager will give appropriate notice if trains cannot be safely operated at the maximum permitted speeds.

249 The railway Rule Book makes provision for circumstances in which a signaller should instruct a train driver to proceed 'at caution', a speed that would allow the driver to stop their train short of any obstruction. RSSB<sup>26</sup> has advised that in an area of absolute block signalling, such as between Carmont and Stonehaven, this would typically follow application of absolute block regulation 4, 'obstruction danger', a process which applies only if a signaller becomes aware, or suspects, that there is an obstruction or other emergency on the track between them and the next signal box.<sup>27</sup>

250 The Carmont signaller was aware of a number of issues caused by the adverse weather on the morning of 12 August 2020, none of which were between his signal box and the next one in the down direction, at Stonehaven. These included the following:

- The landslip at Ironies Bridge, south of Carmont (paragraph 49); this had been reported by the driver of train 2B13 at 07:00 hrs. At 08:47 hrs, the signaller at Laurencekirk advised the Carmont signaller that there was also flooding at this location and said that train 1A43 had been unable to proceed towards Montrose due to the further landslip south of Laurencekirk.
- The flooding that had blocked the line at Newtonhill, north of Stonehaven (paragraph 48); this was mentioned in a telephone conversation between the signallers at Stonehaven and Carmont at 07:13 hrs.

<sup>26</sup> A not-for-profit body whose members are the companies making up the railway industry. The company is registered as Rail Safety and Standards Board Ltd, but trades as RSSB.

<sup>27</sup> Relevant sections of the Rule Book include section 4 of module TS3, section 20.1 of module TS1 and section 25 of module TW1.

- A lightning strike that had caused a power failure at Carmont signal box (figure 53) at about 08:40 hrs; this had disabled the *block bells* used by signallers to communicate between signal boxes, but the *block instruments* controlling train movements were still working. This meant that trains could still be signalled, but with signallers communicating between boxes using telephone calls instead of the block bells.

251 The driver of train 1T08 was aware of a landslip blocking the up line ahead of his train. He was also advised at 09:13 hrs by the Carmont signaller, when discussing movement of the train back to Stonehaven, that the line was blocked between Stonehaven and Aberdeen (although not stated in the conversation, this was due to the flooding at Newtonhill).

252 Both the driver and the signaller were aware of the heavy rain which had fallen during the morning of 12 August. CCTV images show rainfall throughout the southbound journey of train 1T08 from Aberdeen until about 08:50 hrs, well after the train had been stopped by the Ironies Bridge landslip. The signaller had been on duty when radar data shows approximately 50 mm of rain fell in the vicinity of Carmont signal box (figure 57) between 05:35 hrs and 08:55 hrs. This had included periods of intense rainfall from 06:15 hrs to 07:15 hrs and from 07:45 hrs to 08:35 hrs. Although aware of both the rain and some of its effects on the immediate locality, there is no evidence that either the driver or the signaller were fully aware of the risk to railway infrastructure posed by the heavy rainfall.



Figure 57: Carmont signal box looking north

- 253 The Carmont signaller had no indication that the line was obstructed between his location and Stonehaven when authorising the movement of train 1T08 to Stonehaven. After passing his signal box, train 2B13 had passed the location of the washout at 07:07 hrs and reached Stonehaven station at 07:13 hrs, with its driver subsequently confirming that he had seen no indication of a problem (paragraph 50). The Carmont signaller was told that this train had reached Stonehaven during a phone call with the Stonehaven signaller at 07:19 hrs, during which they concluded there was no known obstruction of the up line, so this could be used for the northbound movement of train 1T08 if necessary (the movement was actually made on the down line). Neither signaller had received any indication of an obstruction at the washout location when, at and after 09:08 hrs, they exchanged the messages needed to authorise the northward movement of train 1T08 to Stonehaven.
- 254 By the time the Carmont signaller authorised this movement at 09:28 hrs, the weather had improved significantly (paragraph 57). Evidence that the driver of train 2B13 had not seen a problem when passing the washout location at 07:07 hrs indicates that the driver of train 1T08 would have seen no evidence of a problem when passing the site in the southbound direction eight minutes earlier at 06:59 hrs. RAIB has concluded that, when train 1T08 headed north towards the washout, there was no rule in place that required the train to proceed any slower than the normal maximum permitted speed of 75 mph (121 km/h) at that location.
- 255 When the signaller gave the driver of train 1T08 authority to travel 'wrong direction' (in the down direction along the up line) as far as the crossover, he also advised the driver that, due to the power failure affecting his signal box, he might have difficulty in clearing the signal permitting train 1T08 to travel along the down line to Stonehaven. In the event, he was able to clear the signal normally. During this conversation, the driver queried whether there was any speed restriction to Stonehaven; the signaller replied that the line was fine between Carmont and Stonehaven, and that the driver could proceed at normal speed. In response the driver said that he would be in no rush to get there.
- 256 After travelling slowly past Carmont signal box and once the rear of train 1T08 was clear of the crossover, the driver of train 1T08 accelerated towards the washout. During this journey, the driver briefly shut off power to carry out a running brake test; this is a routine check of brake operation required because the train had reversed direction at the landslip (paragraph 57).<sup>28</sup> OTDR data shows that, as train 1T08 reached the site of the derailment, it was travelling marginally slower than the average speed of the nineteen trains formed of HSTs that had passed the site of the derailment in the down direction on the previous day, 11 August.
- 257 ScotRail has reviewed the OTDR data for the journey of 1T08 approaching the derailment site, and confirmed that it would be *'more than happy to pass a driver as competent based on the driving style'*, and that there were *'no instructions or even any issues known to the driver that would have made them drive any different than how they did that day'*.

---

<sup>28</sup> Module TW1 of the Rule Book.



### Consideration of factors affecting fitness for duty

258 The actions of the signaller and driver are consistent with the Rule Book, and there is no evidence that other signallers and/or drivers would have acted differently in these circumstances. However, RAIB has considered whether there are other factors which could have influenced the actions of the driver or signaller when train 1T08 returned towards Stonehaven.

### Fatigue

259 There is no evidence that fatigue influenced the actions of the Carmont signaller when he decided to authorise train 1T08 to travel northwards, and it is likely that most other signallers would have made the same decision in the same circumstances. However, RAIB has found that his shift pattern included a number of potentially fatiguing factors identified by ORR in its document 'Good practice guidelines - Fatigue Factors'.

260 The signaller had previously worked a 12-hour night shift from Sunday 9 August into Monday, and a 9-hour night shift from Monday 10 August into Tuesday. He reported having a normal sleep when he returned home at about 08:00 hrs on Tuesday 11 August. His next shift then started at 21:47 hrs, so he had been on duty for nearly 12 hours by 09:28 hrs on Wednesday 12 August. His shift finished at 09:45 hrs. This meant four ORR potential fatigue factors were present when he authorised the northwards movement of train 1T08.<sup>29</sup>

261 Network Rail has advised that the shift pattern complied with standard NR/L2/OHS/003 and National Rostering Principles in force at the time. The matter is not pursued further in this report as RAIB has previously made recommendations concerning fatigue risk management for signallers ([RAIB report 28/2009](#), East Somerset Junction) and for other railway industry staff (for instance, [RAIB report 15/2011](#), Shap; [RAIB report 18/2016](#), Reading and Ruscombe; and [RAIB report 18/2017](#), Sandilands).

262 The driver of 1T08 had not been rostered to work since 5 August. Witness evidence indicates that he retired to bed at about 20:30 hrs on Tuesday 11 August, and RAIB concludes he was probably well rested at the start of his shift, just after 06:10 hrs on 12 August.

### Other factors

263 Rail industry employers including Network Rail and ScotRail have procedures for staff in safety critical roles to inform line managers of the details of any medication or drugs that are being taken before they undertake any safety critical work. Both companies also require employees in such roles who have been involved in an accident or incident to be tested for drugs and alcohol.

264 The Carmont signaller was not tested for drugs and alcohol following the accident; Network Rail has advised that this was because he had fully complied with rules and regulations in respect of train movement and safety critical communications. There is no evidence that the signaller was unfit for duty and his actions during the morning on 12 August 2020 do not suggest that he was in any way impaired.

<sup>29</sup> The potential fatigue factors identified using the ORR guidance were: night shifts covering the period between 00:00 and 05:00 hrs (unavoidable on a 24-hour railway), night shifts over 10 hours long, a shift pattern including less than two days rest after a previous block of consecutive nights, and more than 55 hours worked in a 7 day period. Although not on the day of the accident, his shift pattern also included shifts involving less than 14 hours rest in a 24-hour period.

265 The driver of train 1T08 was taking medication prescribed by his doctor. Although the driver informed his employer (ScotRail) that he was taking medication there is some doubt as to whether it was aware when his prescribed dosage was subsequently increased, despite his doctor's notes indicating that he said that his employer was happy for him to increase the dosage. The post-mortem analysis confirmed the presence of this medication, with no evidence of an excess dosage. Records indicate that the driver had not been involved in any safety incident since being prescribed the medication, other than two incidents caused by members of the public. RAIB has carefully considered the medical evidence and consulted with an independent medical expert. It has found no evidence that the driver was medically unfit for driving duties on the day of the accident.

## Consideration of other issues

266 The following issues cannot be completely discounted as factors in the Carmont accident, but available evidence is insufficient to consider them to be causal. In other circumstances, they could have been a factor in an accident.

### Protection of the front wheelset

**267 The HST lifeguards were less robust than those on more modern trains. Although a stronger modern lifeguard may have been better able to move sufficient washout debris out of the path of the leading wheelset to prevent the derailment, RAIB had insufficient evidence to determine the likelihood of this happening.**

268 Lifeguards on rail vehicles are heavy metal brackets fitted immediately in front of the leading wheels of a train. Their purpose is to prevent small<sup>30</sup> obstacles getting under the leading wheels and causing derailment. Figure 58 shows one of the lifeguards fitted to the trailing power car.

269 To allow for suspension movements and wheel wear, lifeguards are mounted with a clearance between the bottom of the lifeguard and railhead (figure 59) to ensure the lifeguard never contacts the railhead during normal operations. The amount of clearance varies between train types and until 2011 there was no specified value in British railway standards. From 2011 the LOC&PAS TSI<sup>31</sup> (now superseded by the LOC&PAS NTSN<sup>32</sup> which imposes the same requirement) applied to new rolling stock and introduced a height range above the railhead of between 30 mm and 130 mm in all conditions. There is a parallel requirement in British domestic standards, introduced from 2011, for a lifeguard to be positioned as close as reasonably practicable to the railhead taking into account wheel wear, suspension movements, suspension wear and assembly tolerances. The clearance of the lifeguards above rail level on the leading power car could not be measured due to the damage they sustained in the accident. The clearance on the trailing power car was measured by RAIB as 58 mm for both lifeguards. The normal operational range for HST power cars is 48 to 85 mm.

<sup>30</sup> Railway Group Standard GM/RT2100 does not define what 'small' means. If the obstacles are smaller than the clearance between the lifeguard and rail (for example, small stones), the lifeguard will not be able to prevent them from getting under the wheels.

<sup>31</sup> Technical Specification for Interoperability for the 'Rolling stock subsystem - Locomotives and passenger rolling stock'.

<sup>32</sup> National technical specification notice.



Figure 58: HST lifeguard (trailing power car)

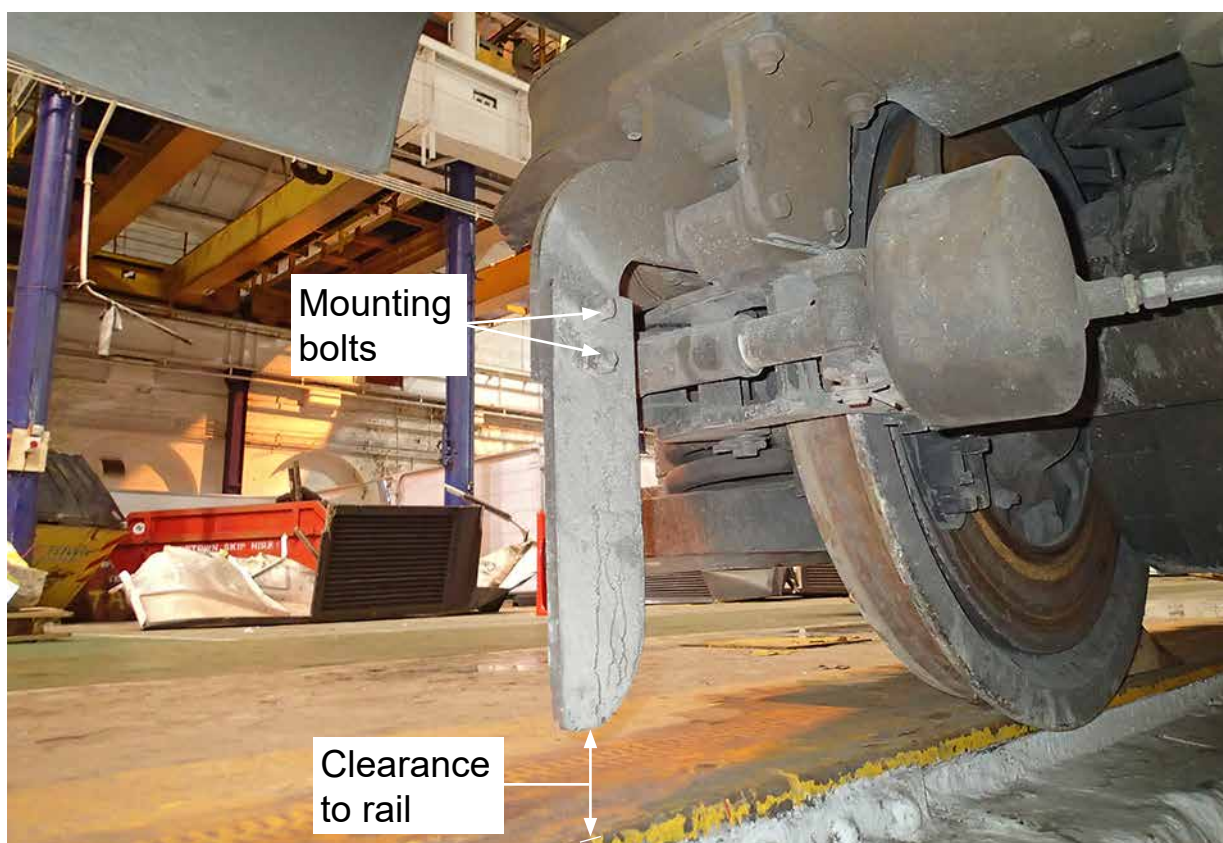

Figure 59: Lifeguard mounting bolts and clearance between bottom of lifeguard and railhead

- 270 Lifeguards are required by modern standards (since issue 1 of GM/RT2100, 'Structural requirements for railway vehicles', July 1994)<sup>33</sup> to be able to resist a sustained concentrated force (proof load) of at least 20 kilonewtons (kN) applied at its bottom edge, horizontally and in a longitudinal direction towards the adjacent wheel without yielding. A simultaneous transverse (that is, side to side) force of 10 kN in either direction is also specified. During deformation beyond the proof load, the lifeguard should deform and be able to resist an ultimate load of at least 35 kN and remain securely attached to the bogie without fouling the track or running gear. If contact with the wheel tread occurs, that contact should not pose a risk of derailment.
- 271 The HST lifeguard was designed before the introduction of GM/RT2100. The lifeguard comprises a vertical blade made from mild steel which is bolted to a bogie-frame mounted bracket by means of two bolts (figure 59). Using design drawings, RAIB has calculated that the ultimate strength of the HST lifeguard is around 15 kN. This is less than half the minimum ultimate strength of lifeguards compliant with current standards. The weakest point of the HST lifeguard is the lower of the two attachment bolts, which shears when the lifeguard is overloaded, allowing the lifeguard to rotate backwards, so preventing it from carrying any significant load and performing a clearing function. At Carmont both lifeguards failed at the bolted joint and rotated backwards. This mode of failure is similar to that seen in a previous accident, but in that case the train struck heavy debris from a fallen bridge parapet, which would have been likely to have damaged a modern lifeguard.<sup>34</sup>
- 272 Both lifeguards of the leading bogie had run through the washout debris, which RAIB has estimated to have been approximately 170 mm and 135 mm deep on the left and right-hand railheads respectively (paragraph 74). The bottom of the lifeguards on the leading power car are likely to have been at a similar height above rail level as those on the trailing power car (58 mm). This means the lifeguards are likely to have engaged with the debris to depths of around 112 mm and 77 mm for the left and right-hand lifeguards respectively.
- 273 The left-hand lifeguard was severely damaged (figure 60), most likely as a result of the leading bogie striking the bridge parapet. The right-hand lifeguard had negligible impact damage on its leading edge, indicating that it probably failed when running through the washout debris and not as a result of subsequent events in the derailment sequence. It is likely that the left-hand lifeguard, which had run through a greater depth of washout debris than the right-hand lifeguard, had also initially failed in a similar manner before sustaining further damage later.
- 274 Had the left-hand HST lifeguard been designed in accordance with modern standards, it might have been better able to cut a path through the washout debris sufficient to prevent the flange of the left-hand leading wheel lifting onto the railhead and into derailment (paragraph 75).

---

<sup>33</sup> Railway Group Standard GM/RT2100 Issue 1, July 1994 'Structural requirements for railway vehicles'.

<sup>34</sup> Collision between a train and a fallen bridge parapet at Froxfield, Wiltshire, 22 February 2015; [RAIB report 02/2016](#), January 2016.



Figure 60: Damaged lifeguards on the leading bogie of the leading power car

### Maintenance and inspection of the drain

275 **Network Rail's process for initiating the inspection and maintenance of new drainage works had not been correctly applied. Consequently, it is likely that the upper section of the 2011/12 drainage system had never been inspected since its completion. Although RAIB has found no evidence to suggest that such an inspection would have changed the outcome, this cannot be entirely discounted. Whether or not relevant to the accident, the absence of proper inspection of a safety critical asset is of great concern.**

276 The drainage teams are intended to carry out an inspection of the drains at frequencies, and using methodologies, that are appropriate to monitoring their condition. RAIB found no evidence that Network Rail undertook any inspection of the drain upslope of CP18 in the period between the inspection of the completed works in March 2013 (paragraph 187) and the accident in August 2020.

- 277 It is uncertain whether an inspection of the drain upslope of CP18 would have led to action which would have prevented the accident. The localised erosion of the drain surface reported in 2012 (paragraphs 186 and 187) suggests that the area of 2011/12 drain near the bund would have shown signs of localised surface erosion throughout most of its life. Even if the damage seen in 2012 had been repaired (there is no evidence of this, but the possibility cannot be discounted), localised erosion is likely to have reoccurred when heavy rain fell subsequently. No problems, such as significant amounts of gravel washed down from upslope erosion, were seen when CP18 and the drain downslope of this were inspected in May 2020 (see paragraph 282). This area was covered in dense vegetation making it difficult for routine inspections to identify problems unless associated with evidence, such as flood debris, extending outside the area of dense vegetation.
- 278 It is therefore likely that any inspection upslope of CP18 in, or before, May 2020 would have found evidence of drain surface erosion limited to a relatively small area. However, it is unlikely that such an inspection would have identified the bund and its potential to divert large amounts of water onto the gravel drain. This is because the bund was outside the railway boundary and became covered with dense gorse in the years following its completion in 2012.
- 279 Since there may well have been no obvious indication that the defect could suddenly become a significant washout, it is not evident that such an inspection would have led to remedial action. Furthermore, it is not possible to determine whether any remedial works would have been sufficient to prevent the washout on 12 August.
- 280 The absence of adequate drainage inspection was a consequence of the failure to fully implement Network Rail procedures for introducing new assets onto its infrastructure, resulting in the completed drain not being entered into Network Rail's maintenance system.
- 281 Information about the lowest section of the drain was held in Network Rail's infrastructure maintenance database, a system called Ellipse. This data originated from a drainage survey undertaken as part of Network Rail's integrated drainage project (IDP). This national scheme was instigated in 2010/11 and was intended to survey earthworks and track drainage where records were incomplete. A survey team visited the Carmont area between May 2011 and April 2012 when only drainage near the railway had been constructed (paragraph 125). The IDP team recorded the parts of the drain that had already been installed: the outlet; the pipe between the outlet and CP19; CP19; and the pipe leading towards CP18. CP18 had not been constructed at this time so the open end of the pipe was recorded as an inflow.

- 282 On 13 May 2020, two members of Network Rail staff based at Perth maintenance depot carried out an inspection of drainage assets in the Carmont area as recorded in Ellipse. This was the first inspection as part of a new programme of drain condition inspections based on module 01 of standard NR/L2/CIV/005.<sup>35</sup> As this only included the drain below CP18, they inspected only these assets plus CP18 which was close to the position where the inlet had been seen by the IDP team. As no other assets were listed in Ellipse, the inspection team did not, and were not required to, climb further up the steep gorse-covered slope to seek additional assets upslope of CP18. The inspection did not find evidence that any washout-related features upslope of CP18 had resulted in flooding or deposition of debris in the area inspected downslope of CP18.
- 283 When construction was completed, the remainder of the Carmont drainage system should have been, but was not, entered onto Network Rail's Ellipse system, to trigger routine inspection and maintenance activities. This did not happen due to a failure to fully implement Network Rail procedures for introducing new assets onto infrastructure as required by standards NR/L2/MTC/088 and NR/L3/MTC/089 (paragraphs 179 to 184).
- 284 Post-accident enquiries identified other projects for which drainage assets had not been transferred into the maintenance process. This is discussed further at paragraph 296.
- 285 An opportunity to recognise that almost all the 2011/12 drain was missing from Ellipse appears to have been missed in May 2016 when the landowner's agent contacted a member of Network Rail's property division by email. Although the correspondence was about a different issue, the message concluded by stating:
- 'No maintenance appears to have been carried out on the interceptor drain for some years, the surface of which is currently now blinded over almost completely and in my opinion will not be able to intercept any surface water flows from adjacent farm land.'*
- 286 There is no evidence that Network Rail replied, or took any other action, in response to this email. While the issue of silting of the drain along the edge of the field is unrelated to the accident, an appropriate response from Network Rail would have identified that the asset was missing from, and so required adding to, its maintenance system.

---

<sup>35</sup> NR/L2/CIV/005 issue 1 published 2 June 2018 'Drainage asset management'.

## Health and safety files

**287 Neither RAIB or Network Rail could find any trace of the health and safety file for the Carmont drainage works. There is evidence that Network Rail's processes related to the creation and management of health and safety files were not being correctly applied in Scotland and elsewhere in the UK.**

### The health and safety file for the drainage works at Carmont

288 NR/L2/INI/CP0047<sup>36</sup> describes Network Rail requirements and arrangements for the application of the CDM regulations. These regulations established the duties of the 'CDM coordinator'. This was a named Network Rail employee, but in practice the role was taken by Network Rail Infrastructure Projects at an organisational level. The purpose of this role was to co-ordinate inputs from other parties with the deliverables needed to create or update a H&S file. Network Rail was therefore responsible for ensuring that correct documentation was collated upon project completion. The standard required Carillion (as Principal Contractor) to pass information to the CDM coordinator for inclusion in the H&S file.

289 The regulations mandate that this file should contain all of the information needed for the safety of future construction activities involving the new asset, and the 'client' (Network Rail in this instance) is required to retain it until the infrastructure is removed. It is generally considered essential to include as-built drawings as part of a H&S file, since they are needed for future construction activities involving the asset.

290 Standard NR/L2/INF/02202<sup>37</sup> applied to Network Rail staff and Network Rail contractors who carried out work where Network Rail was the client. It specified the records management processes for:

- agreeing, before construction started, the content of the H&S file
- the delivery and acceptance of H&S files
- the onwards management and update of H&S files.

291 The standard also required that all as-built records should be delivered to Network Rail's record centre and should be traceable via the H&S file.

292 Although witness evidence suggests the possibility of some associated documentation being provided by Carillion, neither RAIB nor Network Rail has found any trace of the H&S file or as-built records for the Carmont drainage works. Furthermore, Network Rail has been unable to provide evidence that a H&S file was ever received from Carillion and there is no trace of a H&S file in available Carillion records. Arup records indicate that it expected a file to be created, but none is available from these records and there was no requirement for Arup to hold a completed file.

<sup>36</sup> NR/L2/INI/CP0047 issue 4 published 6 March 2010 'Application of the Construction Design and Management Regulations to Network Rail construction works'.

<sup>37</sup> NR/L2/INF/02202 issue 4 published September 2009, issue 5 published June 2011 'Records management of health and safety files'.



- 293 RAIB has considered whether provision of the H&S file in accordance with the CDM regulations would have resulted in a different outcome on 12 August 2020. RAIB concluded that the process needed to generate as-built drawings could have led to a recognition of the critical differences between the design and the installed drainage system (this is covered by paragraphs 130 to 154). However, even had the H&S file and associated as-built drawings been captured by Network Rail's record centre it seems unlikely that this would have led the asset management or maintenance team to identify the risk created by the deficient installation of the 2011/12 drainage system. This is because they would have had no reason to examine the file and drawings until it was necessary to carry out further construction work at that location.
- 294 Transfer of a completed H&S file (with associated as-built drawings) would have been achieved for the Carmont project if Network Rail's standards had been fully applied. With this in mind, RAIB sought to understand the extent to which the absence of compliance with these standards was symptomatic of a wider problem, or related to particular characteristics of the joint Network Rail/Carillion team at the Bishopbriggs office.

*Health and safety files, and transfer of assets into maintenance, at other locations*

- 295 RAIB asked Network Rail for information concerning other H&S files which, as the client, it should have retained for other projects completed by Carillion in 2012. Network Rail used its purchase order system to determine that H&S files should be available for between 48 and 64 projects. Network Rail stated that it held H&S files for only 16 of these.
- 296 RAIB also sought to quantify the extent to which new works had not been transferred into maintenance. In response to a request from RAIB, Network Rail identified 11 drainage schemes completed in Scotland from 2014 to 2019 and which should have resulted in new drains being transferred into Ellipse, the Network Rail maintenance system. Network Rail stated that 5 of these 11 schemes had not been transferred (these schemes did not involve Carillion).
- 297 The above evidence shows that the transfer of information from infrastructure projects to the infrastructure managers was deficient in Scotland. Witness evidence also indicates that the inefficient transfer of asset knowledge from constructors to maintainers was a known problem across other Network Rail routes.

### 'Extreme weather action team' (EWAT) meetings

298 **Custom and practice in Scotland's route control meant that extreme weather action team (EWAT) meetings were not always convened when required by Network Rail's processes, and no such meeting was called on 11 or 12 August 2020 despite forecasts of severe weather. However, even had an EWAT been convened it is considered unlikely that Network Rail would have taken the actions needed to avoid the accident.**

299 National standards required Scotland's route control to declare a red route alert status, with required consequences including convening an EWAT to manage weather-related actions such as safety mitigation, if a breach of an extreme weather threshold was included in a weather forecast and/or actually occurred. Route control staff practice meant that EWATs were not called for some forecast extreme weather events and would not normally be called if thresholds were breached when this had not been forecast. Other variations from national standards included the requirements relating to how an EWAT should be conducted.

300 Potential consequences of these shortcomings included:

- Omitting a fully effective check that all necessary actions were being taken (the EWAT agenda acts as a checklist, but the agenda in Scotland's A&EWP (Section J.3.3) lacked the detail provided by the agendas in national standard NR/L3/OPS/021/12).
- The risk that informal communication, used in practice instead of the formal EWAT process, would lead to omission or loss of important messages.
- The absence of a forum where combined input from several disciplines can lead to identification and resolution of problems which have been missed – particularly important as extreme weather can cause unexpected events which may be outside the experience of some individuals.
- The potential for omission of planned mitigation at earthworks on the 'at risk' list if unexpected intense rainfall means the on-call geotechnical staff have not been alerted by control, a particular risk at night.

301 These shortcomings were not directly causal to the accident on 12 August 2020 for reasons explained at paragraph 209 and were, to some extent, mitigated by teleconferences held every day in which operational matters were discussed by route control, asset management and delivery unit (maintenance) staff.

302 NR/L2/OPS/021 sets out the process to deal with days when weather meets the red status thresholds (and are therefore declared 'red days' by the RCM). 'Red days' are those on which weather-related actions are required, such as applying mitigation for earthworks on the 'at risk' list if the red threshold is met for rainfall. The process was based on a five-day weather forecast issued shortly before 03:00 hrs each day and containing the forecast for the 24 hours starting at 06:00hrs that day and then for each of the following four days. The weather forecast included the status for specific hazards including 'heavy rain accumulation' and 'convective rainfall intensity' (appendix J).

- 303 The NR/L2/OPS/021 process required the RCM to send out the weather forecast and associated alert status information so that other staff, including delivery units (maintenance teams) and asset management staff, could act on these. On receiving a forecast including a red day, the relevant delivery units were required to hold a conference to review the impact of the impending weather conditions and to allocate resources accordingly. Appropriate preparatory actions were also required from asset management staff. Route control staff were required to convene one or more EWATs with purposes that included the assessment of extreme weather impact and agreeing appropriate mitigation, monitoring and contingency plans. Unless a later forecast had removed the red status, mitigation appropriate to the type(s) of weather was then applied on the red days with further EWATs being held if the participants considered it necessary.
- 304 The early part of NR/L2/OPS/021 described the process in the context of receiving several days' notice of the weather event, with a subsequent section providing a variant to the required response if a weather forecast escalated to an extreme event with less than 24 hours' notice or outside of office hours. There was no reference to the frequency at which forecasts should be received, excepting the daily forecast which was required by 03:00 hrs each day. No explicit process was given to deal with circumstances in which red status weather occurs when not forecast. However, the potential for red days to occur without being forecast was apparent in NOP 3.17 and the following definition of a red day in NR/L2/OPS/021:
- 'A Red Day is declared when one of the following applies:*
- a) if the forecast that an Extreme Weather Threshold will be breached;*
  - b) If the forecast that Multiple Adverse Weather Thresholds will be breached;*
  - c) an actual Extreme Weather Threshold has been breached; and*
  - d) actual Multiple Adverse Weather Thresholds have breached.'*
- 305 As required by NR/L2/OPS/021, the forecast (appendix J) included a confidence level for each weather status, ranging from high to low. Neither NR/L2/OPS/021, nor any of its subsidiary processes, provided guidance on how to use this confidence level data.
- 306 Rain-related forecasts received at 02:57 hrs on the morning of 11 August and at 02:51 hrs on the morning of 12 August are summarised in table 3. The 'heavy rain accumulation' and 'convective rainfall intensity' hazards for 12 August (the day of the accident) were not forecast the previous day and were given low confidence ratings when predicted on 12 August. The RCM did not declare a red day, or call an EWAT meeting, as a result of receiving the weather forecasts on 11 August (four extreme weather parameters, in three areas, for that day) or 12 August (one extreme parameter). This was because he concluded the forecast weather was not sufficiently adverse to require this.

<b>Forecast issued</b>		<b>11 August</b>		<b>12 August</b>
<b>Predicted to occur on</b>		<b>11 August</b>	<b>12 August</b>	<b>12 August</b>
<b>Perth area, incl. accident site</b>  <i>Hazard rating (confidence in brackets)</i>	<b>Heavy rainfall</b>	Extreme (Low)	No hazard (Low)	Extreme (Low)
	<b>Convective rainfall</b>	Aware (Low)	No hazard (Medium)	Aware (Low)
	<b>Lightning</b>	Adverse (Low)	Adverse (Low)	Adverse (Medium)
<b>Edinburgh, Motherwell, Glasgow and Highland</b>  <i>Number of areas with each hazard rating, confidence data not tabulated here</i>	<b>Heavy rainfall</b>	Extreme - 1 Adverse - 2 Aware - 1	Aware - 2 No hazard - 2	Aware - 2 No hazard - 2
	<b>Convective rainfall</b>	Aware - 4	Aware - 2 No hazard - 2	Aware - 2 No hazard - 2
	<b>Lightning</b>	Adverse - 2 Extreme - 2	Aware - 2 Adverse - 2	Aware - 1 Adverse - 3
<b>Route alert code allocated by RCM</b>		Adverse	Aware	Aware

Table 3: Rain-related hazards in weather forecasts and route alert statuses (for areas shown in figure 56)

- 307 The wording of NR/L2/OPS/021 was reviewed by RAIB with the individuals within Network Rail responsible for the design and approval of the extreme weather management system. They confirmed that the intent of the process was that a 'red day' would be declared if a forecast included a single 'extreme' element within it. Evidence from other Network Rail control centres indicates that other controls applied NR/L2/OPS/021 in this way.
- 308 Witnesses stated that in Scotland a 'majority of areas' approach was taken so a 'red day' would be declared by the RCM if extreme weather was forecast in three or more of the five forecast areas for Scotland (figure 56). However, events in the lead-up to the accident demonstrates that this approach was not consistently applied (for example, the forecast for 11 August contained extreme weather forecast in three of the five areas and yet no 'red day' was declared).
- 309 The use of RCM judgement to decide whether a red day should be declared is consistent with older versions of NR/L2/OPS/021. Issue 5, published in June 2011, stated '*The route control manager (RCM) shall interpret the [weather] information and assign the status of alert*'. The approach was changed to that described above when issue 6 of NR/L2/OPS/021 was published in March 2016 with a compliance date of June 2016.
- 310 There is evidence that the number of EWATs convened by Scotland's route control in the years before the accident at Carmont was fewer than would have been expected had the national operations standard governing the response to extreme weather events (NR/L2/OPS/021) been implemented in the way intended by Network Rail (for example, RAIB found almost no records of EWATs having been convened in 2014 and 2015) (figure 61). This is surprising given the frequent occurrence of major weather events in Great Britain and the severity of weather in Scotland relative to other parts of the country.

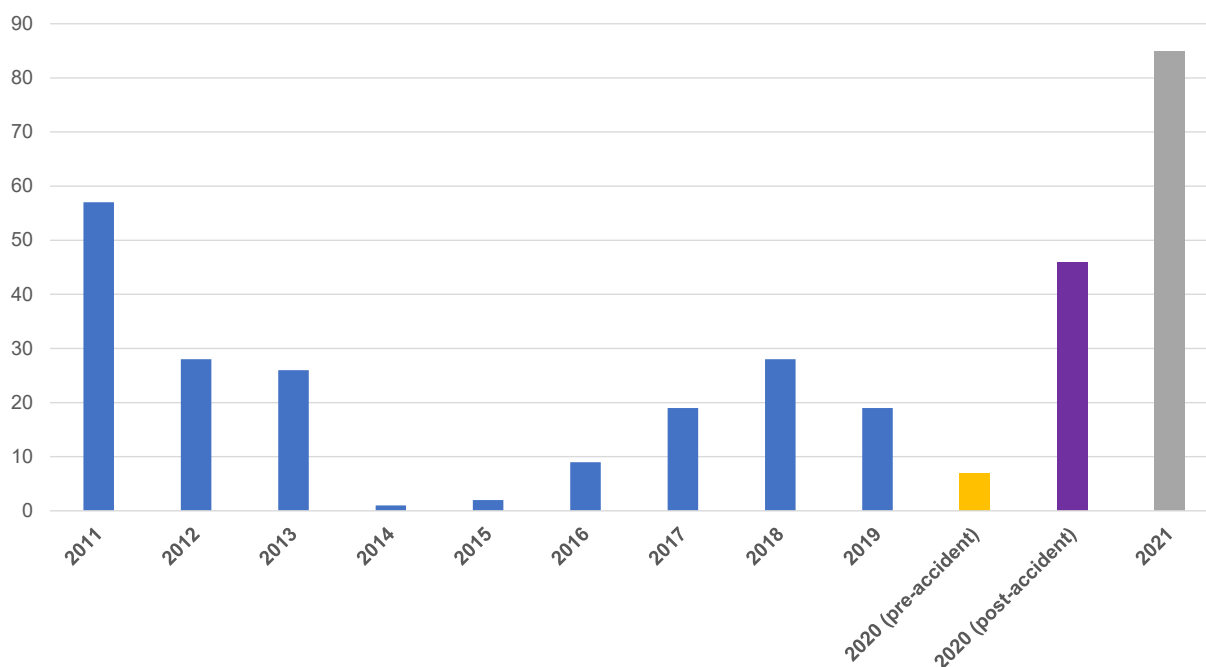

Figure 61: Number of EWATs convened in Scotland 2011 to 2021 (based on records provided by Network Rail and ScotRail)

311 The reason for the relatively low number of EWATs is thought to relate to the publication of a report commissioned by Network Rail Scotland in 2012 following widespread disruption to the network on 3 January 2012 due to a severe storm and high winds. This report identified a number of weaknesses in the management of the incident, including poor management co-ordination and control. It included a recommendation that:

*'detailed analysis of the records of weather forecasts, EWATs and subsequent events should be undertaken to enable the development of an EWAT process more appropriate to Scottish infrastructure and weather. The objective is to hold fewer, better focussed EWATs which will identify days of substantial threat and initiate the appropriate response.'*

312 Although the report appears to have had no official status, witness evidence suggests that it was widely interpreted to mean that EWATs should only be called for the most serious of weather-related events.

313 The actual amount of rainfall in some parts of Scotland on 12 August was well in excess of the red threshold (paragraphs 42, 43 and 199) but no EWAT was called. Responding to real-time weather observations was not mentioned in Scotland's A&EWP, although this did cover management of consequences such as flooding. Witness evidence shows that route control staff did not consider that they were expected to respond to real-time weather observations and were heavily reliant on the daily forecasts issued at 03:00 hrs rather than any subsequent short-term forecasts. The NRWS installed in the control room had not been configured to provide this information and route control staff had not been trained to use it to assist decision making (paragraph 219).

- 314 The competence management system for route control staff (paragraphs 242 to 245) included a section on managing adverse weather which assigned responsibility for allocating the route alert status to RCMs. The RCM on the night of 11/12 August 2020 had been assessed as competent in this module. These competency assessments did not detect that Scotland's control staff were allocating route alert codes in a manner that was not compliant with Network Rail standards.
- 315 Evidence provided by Network Rail indicates that no route control staff in Scotland, or elsewhere, had been systematically trained to use NRWS to identify when real-time weather data had reached the thresholds at which NR/L2/OPS/021 required them to implement the extreme weather management process for events which had not been forecast. There is no evidence that other staff had been trained, or were required, to provide this information to route control staff.
- 316 Unit 10 of the Network Rail National Operating Procedure 2.02 for competence management of route control staff (paragraph 244) required them to demonstrate underpinning knowledge including:
- *appreciation of weather forecasting and how the railway uses weather alerts*
  - *arrangements in the case of extreme weather and the role of the Extreme Weather Action Team (EWAT)*
  - *the safety risks associated with the different weather conditions*
  - *awareness of the different weather and associated hazard alert levels.*
- 317 Although the RCMs on the night of 11/12 August and during the dayshift on 12 August had been assessed as competent, this did not identify that their approach to the calling of EWATs was inconsistent with NR/L2/OPS/021 requirements for an EWAT when a single weather hazard was forecast as red. The competency management system did not include a requirement for route control staff to have the detailed knowledge required to use NRWS, despite this being the source of the short-term weather forecasts and actual weather observations needed for them to comply with the NR/L2/OPS/021 requirement to call an EWAT when the need for this had not been identified in the 03:00 hrs daily forecast.

## Identification of underlying factors

### The management of extreme rainfall events

**318 Network Rail's management processes had not addressed weaknesses in the way it mitigated the consequences of extreme rainfall events.**

### Background to Network Rail's senior management processes

319 Paragraphs 320 to 334 summarise the arrangements that Network Rail had established to assure the safety of its activities as infrastructure manager, nationally and in Scotland.

### Network Rail's national team (HQ)

320 Network Rail sets safety policies and direction for the safety management of the organisation through a structure of formally appointed committees and groups. These were also tasked with monitoring and reviewing safety performance.

- 321 The structure of senior management safety meetings, documented in Network Rail's 'Health and Safety Management System' (HSMS), is summarised below:
- Network Rail Infrastructure Ltd board meets monthly and has overall responsibility for corporate governance.
  - The safety, health and environment (SHE) committee of the board holds roughly four to five meetings per year, and is attended by the chair of Network Rail's board, the chief executive officer, directors, non-executive directors (one of whom chairs the meeting), senior managers and subject experts from within Network Rail. The meetings also include guest speakers and presenters from the routes and other parts of the business. On occasions, ORR's chief inspector would attend at least part of the meeting.
  - The executive committee is a strategic level meeting which is attended by members of Network Rail's executive leadership team (corporate directors and regional managing directors). It is responsible for the day-to-day running of the organisation, but it is also responsible for agreeing the strategy and objectives necessary to deliver Network Rail's safety and sustainability goals. It meets regularly throughout the year, is chaired by the chief executive and is attended by senior managers and nominated directors.
- 322 The part of Network Rail with the overall responsibility for leading the development of safety policy, and developing national safety initiatives, was the Safety, Technical and Engineering (STE) directorate (later the Technical Authority). Included in this directorate was a quality, health, safety and environment team which was responsible for leading the development of strategy, and the setting of the safety standards that routes were required to apply.
- 323 The primary responsibility for the local implementation of Network Rail's safety policy and mandated standards and procedures sat with the managing director of each route and their team. Within each route, the route safety, health and environment team provided support and advice to the route managing director and the chief operating officer.

### Network Rail and the ScotRail Alliance

- 324 In Scotland, since 2014, a formal alliance has been established between Network Rail and ScotRail. The intention of the alliance is to facilitate closer co-operation to make the rail industry in Scotland more responsive to its customers. Although in most respects the two organisations operate separately, the same person is managing director for each. This individual therefore leads two teams and is accountable to the boards of both organisations (figure 62). Oversight of this formal arrangement is provided by an Alliance Board, which is chaired by the Abellio UK managing director and attended by the Scotland's Railway/ScotRail managing director, the chief executive of Network Rail and a senior representative of Transport Scotland (a Scottish Government body).
- 325 Within the two organisations which form the alliance are separate management chains and working meetings, many of which will involve representation from the partner organisation. Top level co-ordination is provided by an Alliance Executive which is chaired by the managing director.

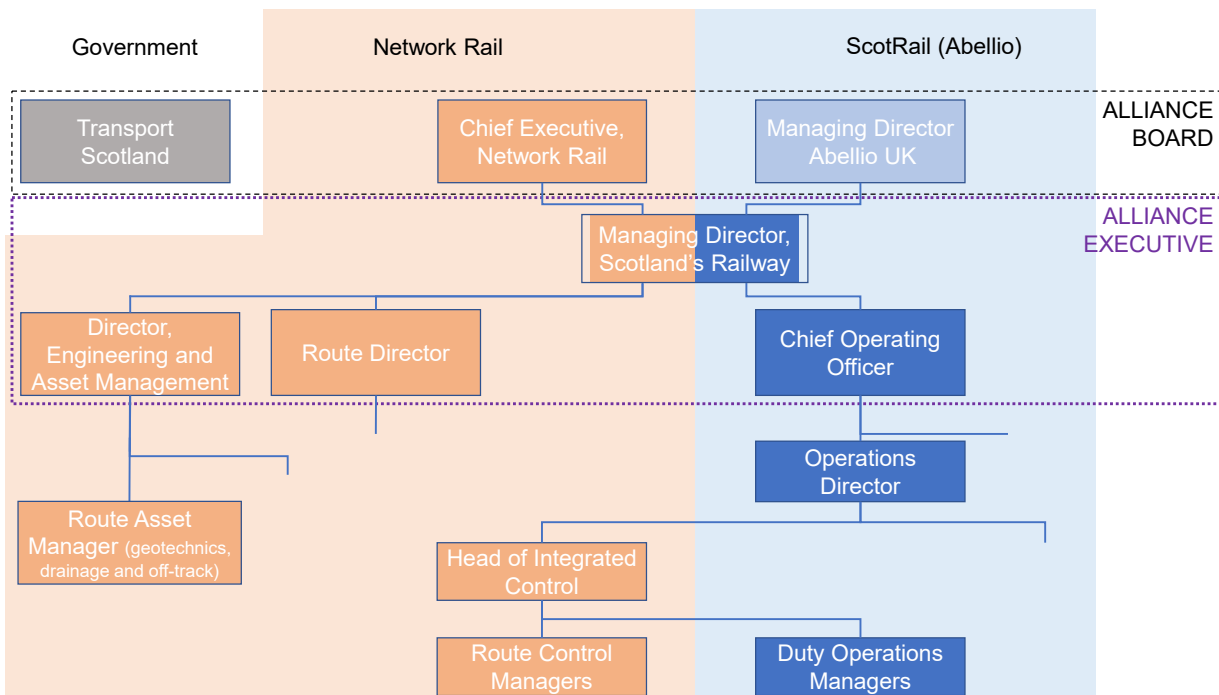

Figure 62: Organisation of the Alliance in Scotland (only selected posts shown)

326 Although the extent of integration between management and delivery teams is limited, the route control was one area which provided a greater degree of integration. For this reason, a single 'integrated' route control had been established under a single manager, the head of integrated control, who reports to ScotRail's operations director. The on-shift staff, including Network Rail RCMs and the ScotRail DOM, report to the head of integrated control.

327 The route's professional lead for the management of geotechnics, drainage and off-track assets was the RAM (Geotechnics). This individual and other members of his team would provide advice to the maintenance delivery units who were responsible for providing the staff to implement mitigations at high risk locations (such as the appointment of a watchman to observe and report conditions).

### Senior management's awareness of extreme weather issues

328 Witness and documentary evidence indicate that the executive leadership team (see paragraph 336) at Network Rail HQ was becoming increasingly concerned about the risk posed by extreme rainfall to the railway's infrastructure in the decade leading up to the accident at Carmont. These concerns were heightened by the landslide just outside the portal of Watford tunnel, Hertfordshire, in September 2016 that caused the derailment of a train and a subsequent glancing blow, inside the tunnel, between the derailed train and a train on the opposite track. Discussions at the meeting of Network Rail's executive committee and the Board's SHE committee in November 2016 covered a range of issues, including:

- the need to review the earthworks and drainage on the approach to Watford tunnel
- the use of *guard rails* at high risk sites such as viaducts and a need for review of the strategy and criteria for their fitment
- more extensive use of satellite images to identify issues on neighbouring land



- the plans for a risk-based review of cutting slopes at tunnel portals taking into account drainage and water flows.
- 329 There was also a detailed discussion about the steps that had been taken by the London North Western Route, after the accident at Watford, to mandate a management review as soon as reasonably practicable in the event of the rainfall forecast being upgraded to ‘adverse’ or ‘extreme’ at short notice. Topics that were raised also included the need to practise the response to extreme rainfall events and to better understand the conditions that lead to convective storms. This also spurred the development of a tool to better predict and track convective storms (development of this ‘Convective Analysis Tool’ was concluded shortly after the accident at Carmont).
- 330 In the period between the accident at Watford tunnel and the derailment at Carmont, the senior management teams continued to consider the potential for infrastructure failure caused by extreme weather. The topics discussed included:
- the reasons for the unsatisfactory management of drainage assets revealed by a level 2 audit (SHE committee, 27 April 2017)
  - the resilience of railway infrastructure to extreme weather (SHE committee, 6 September 2017)
  - the case for investment to fund additional earthworks activity (Board, 7 February 2018)
  - the management of geotechnical and drainage assets by Scotland’s Railway (Board, 20 September 2018)
  - managing the risk of hot weather *buckling* rails (executive committee, July 2018 and August/September 2019)
  - the incident on 13 June 2019, near Corby, when passengers were stranded on trains for many hours due to a landslip blocking the line, and flooding (Board, 28 June 2019) ([RAIB report 04/2020](#))
  - an overview of earthworks management and opportunities to deliver improvements to earthworks stability (based on presentations to the executive leadership team in January and July 2020).
- 331 A primary source of safety performance data for Network Rail’s senior management team was the STE/technical authority Safety, Health and Environment Performance (SHEP) report. The four-weekly report, which included data relating to a number of ‘key performance indicators’ and supporting information, was intended to communicate safety performance against agreed targets, with commentary to explain over and under-achievement, and to explain what was being done to address adverse trends. The report was primarily for leaders across the rail industry but was also shared with the regulator and RAIB and placed in the public domain.
- 332 The SHEP report showed that from early 2018 the risk<sup>38</sup> associated with earthwork failure was rising significantly (figure 63 and see paragraph 385). Consequently, the risk of earthwork failure was seen to be accounting for a greater proportion of the overall train accident risk.

<sup>38</sup> The train accident risk is expressed as an estimate of overall harm per year, a measure known as fatalities and weighted injuries (FWI).

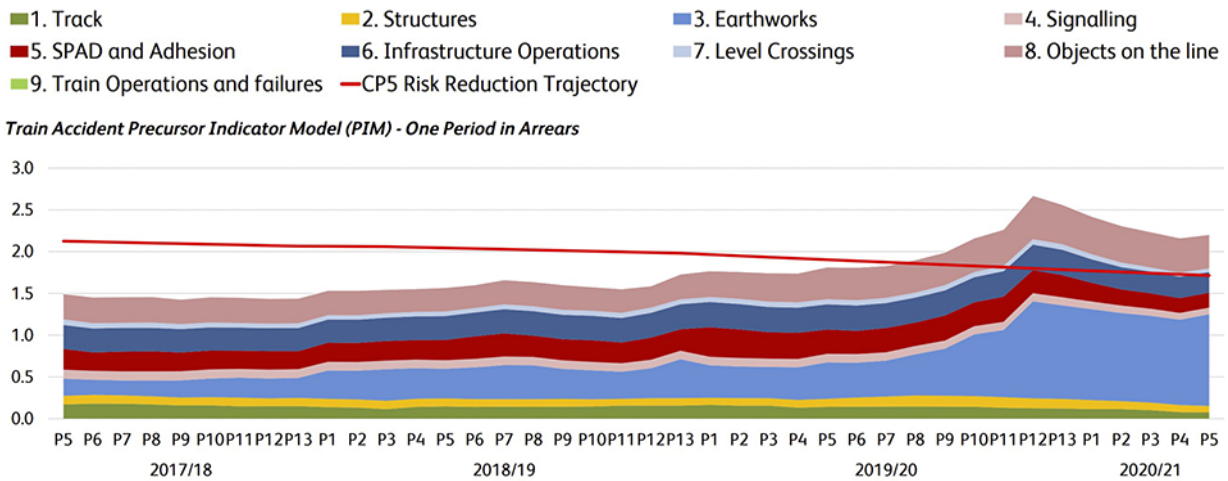

Figure 63: Outputs of the train accident precursor indicator model showing the rise in risk associated with earthwork failure, relative to other precursors. (Extract from Network Rail’s Safety, Health and Environment Performance report for period 6 of 2020/21).

333 Since such failures would often result in a significant disruption of the rail network, discussions at senior management meetings would reflect concerns about the impact on safety and train performance. In particular, the safety implications of sudden and undetected infrastructure failures were often discussed, and concerns were expressed about the potential for a catastrophic derailment.

334 A major focus of the executive leadership team’s discussions (at HQ and within Scotland’s Railway) was the ways in which ageing infrastructure could be made more resilient to the challenge posed by extreme weather. It was with this in mind, that part of the additional funding sought and secured by Network Rail for control period 6 (2019 to 2024) covered the cost of improving the resilience of the infrastructure at a number of locations. In the case of Scotland, this additional funding represented a 22% increase in the overall budget for operations, maintenance and renewals, with one-third of the increase dedicated to weather resilience works.

Network Rail’s approach to the management of extreme rainfall events

335 Network Rail’s management processes had not addressed weaknesses in the way it mitigated the consequences of extreme rainfall events because:

- there was insufficient recognition of significant areas of weakness in its existing mitigation measures (paragraphs 336 to 358)
- areas of weakness in the implementation of extreme weather risk control measures had not been detected by Network Rail’s management assurance process (paragraphs 359 to 373)
- there were gaps in Network Rail’s understanding of the risk posed by extreme rainfall (paragraphs 374 to 396).

Each of these areas is now discussed in turn.

## Network Rail's measures for the management of extreme weather events

**336 Despite an increasing awareness of the threat, Network Rail had not sufficiently recognised that its existing measures did not fully address the risk from extreme rainfall events, such as summer convective storms.**

### The 'Weather Resilience and Climate Change Adaptation Strategy'

337 An internal audit carried out in June 2016, as part of Network Rail's level 2 audit programme (see paragraph 364), examined weather resilience and climate change adaptation (WRCCA) activities. It raised several issues around ownership and governance and concluded that there was '*a lack of a consistently applied, Route understood, methodology to identify at-risk sites for inclusion and exclusion in Adverse/Extreme Weather Plans*'. In response, Network Rail's STE directorate published a strategy in January 2017 for the delivery of weather resilience and climate change adaptation activities in Network Rail.

338 The strategy document described Network Rail's overall vision as '*a railway that is safe and more resilient to the effects of weather, now and in the future*'. The overall objectives of the strategy were stated to be the provision of:

- infrastructure which can withstand the impact of future weather conditions
  - rapid recovery from the impacts of adverse and extreme events
- and consequently:
- improved performance and safety during adverse and extreme weather conditions
  - financial savings through reduced compensation payments and repair costs
  - enhanced reputation and trust in the railway's ability to manage weather events.

339 The strategy document described areas in which Network Rail felt it was making progress, including an improved weather forecasting system, better incident management, liaison with train operators by means of a national task force focused on weather resilience and strengthened operational standards. It also identified a number of areas for improvement that included drainage management, more collaboration with authorities involved in managing and responding to weather events (for example, Local Flood Resilience Forums), identifying locations on the national network which could be affected by flooding and the identification of new and innovative approaches to managing the seasonal impact of leaf fall and ice on the *conductor rail*.

340 Critically, the strategy was silent on the risk to earthworks posed by the kind of intense and volatile rainfall events that cannot be reliably forecast. This omission was significant given that this risk had been highlighted by landslips caused by intense summer rainfall events,<sup>39</sup> had been considered by Network Rail national weather event response programme workshops in November 2014 and was acknowledged in Network Rail responses to RAIB recommendations made in 2014 (see paragraph 397).

<sup>39</sup> For example, landslips at Rosyth and St. Bees in July and August 2012.

- 341 The 'on the ground' implementation of the WRCCA strategy fell to the director of route asset management (DRAM) in each route. Routes were required to develop a Weather and Climate Adaptation Plan which described how it would deliver:
- the identification and implementation of proactive resilience measures
  - designing for future resilience in line with Network Rail's policies and procedures
  - regular maintenance and inspection of drainage, vegetation and other assets
  - operational management of weather events, including incident response
  - identification of lessons learned to improve performance and safety.
- 342 The WRCCA plan for Scotland was issued by Scotland's Railway in September 2014. It identified the plans that the route had formed to address the resilience and safety of its infrastructure and a range of commitments that included increasing the understanding of climate change impacts on Scotland's Railway and improving operational responses to extreme weather events. It also stated that the route was seeking continuous improvement of its weather-based decision support tools, including weather stations and real-time weather forecasting.
- 343 The plan outlined the steps that the route was taking to address the resilience of its infrastructure and the process for managing extreme weather events. However, it made no specific mention of the particular challenges posed by intense and volatile weather events such as convective storms.

#### *The identification of 'at risk' earthworks*

- 344 The vulnerability of earthworks to extreme weather was referred to in Network Rail's Earthworks Technical Strategy (2018). This required the adoption of a risk-based process to identify 'at risk' assets that considered both the likelihood of an earthwork failure and the potential consequence should it occur. This was designed to enable the prioritisation of preventative measures (to reduce the likelihood of earthwork/drainage failure) and mitigation measures (to reduce the consequences of earthwork/drainage failure) during extreme weather events. This requirement was met by standard NR/L2/CIV/086,<sup>40</sup> which laid down a detailed process for the examination, evaluation and risk assessment of Network Rail's earthworks.

#### *Network Rail's overall approach to the management of earthwork failures due to extreme rainfall*

- 345 Before the accident at Carmont, Network Rail's overall approach to the management of earthwork failures due to extreme rainfall can be summarised as follows:
- a) Examine, evaluate and risk assess earthworks (taking account of drainage assets and the potential consequences of derailment).
  - b) Based on the output of a), identify the assets considered to be at particular risk in case of extreme rainfall.
  - c) Consider the need for additional works to improve the resilience of earthworks/drainage assets that are considered particularly vulnerable to extreme rainfall and implement these improvements where appropriate.

<sup>40</sup> NR/L2/CIV/086 'Management of Earthworks Manual' issue 9 published March 2019.

- d) Inspect and maintain the condition of earthworks/drainage assets, particularly those considered to pose a higher risk to trains.
- e) Define appropriate mitigation measures to be implemented in case of extreme weather.
- f) Obtain forecasts of weather events, conduct a multi-disciplinary review (known as an EWAT) and trigger implementation of the mitigation measures as appropriate.
- g) Monitor the situation during the weather event and conduct further reviews as appropriate.

346 As can be seen from the above, Network Rail's strategy for the management of risk associated with extreme rainfall had identified the need to implement engineering works to improve the resilience of assets. With regard to the operational response to extreme weather events, its strategy was critically reliant on the identification of high-risk locations and introducing additional control measures at those specific locations. These additional control measures were generally one of the following:

- deploying people to watch high-risk locations
- cab riding at under 60 mph (97 km/h) to observe the condition of the infrastructure
- train drivers examining the line at low speed
- temporary speed restrictions
- using a train to prove the route (see paragraph 566).

If none of the above control measures could be implemented, it was also permitted to allow trains to pass high-risk locations at reduced speeds, none exceeding 40 mph (64 km/h).

347 RAIB observes that the success of the overall approach adopted by Network Rail was reliant on the following statements being true:

- a) It is possible to forecast rainfall at a particular location with reasonable accuracy, and sufficiently early to plan a response.
- b) It is possible to reliably pinpoint those locations at which the risk of infrastructure failure is highest.
- c) It is possible to deploy sufficient resource to implement the measures that are specified.
- d) It is possible to monitor and respond appropriately to a weather event once it is in progress.

348 With regard to a) above, it was clear from Network Rail's own experience and RAIB investigations that certain types of weather event are very difficult to forecast accurately, particularly intense and volatile rainfall events such as summer convective storms.

- 349 With regard to b) above, there was mounting evidence that implementation of additional risk control measures at locations considered to be high-risk was not the whole solution to the problem. Network Rail classifies its earthworks according to the assessed likelihood of failure on a scale from A to E. Those in category A are considered to have the lowest likelihood of failure, whereas those in category E the highest. In 2019/20, 59% of reported earthwork failures occurred in earthworks which Network Rail had considered to have a relatively low likelihood of failure (categories A to C).<sup>41</sup> Since the population of earthworks in categories A to C is much greater than for categories D and E, this is unsurprising - the likelihood of any individual category A earthwork failing remains much lower than it is for a category E earthwork. However, the prevalence of failures in the large number of low likelihood earthworks demonstrates the inherent unpredictability of earthwork failure and the fact that all earthworks, whether or not assessed to be at high likelihood of failure, may fail, particularly if the ground is already saturated by previous precipitation.
- 350 With regard to c) above, it was clear that in most cases the deployment of sufficient resource to every 'at risk' location required that considerable notice be given to allow identification and mobilisation of the people and equipment required. However, such notice was heavily reliant on accurate forecasting, which was problematic for certain types of weather event, such as convective rainfall.
- 351 With regard to d) above, Network Rail had yet to establish suitable arrangements to manage the network during fast-moving and unpredictable rainfall events, such as convective storms. Controllers had access, via the NRWS, to hour-by-hour local forecasts and real-time rainfall data (paragraph 219). However, at the time of the accident, NRWS had not been configured for the purpose of real-time control, operating procedures had yet to be written and controllers had not been trained in its use. Consequently, controllers were largely dependent on reports from train crew, signallers and outside agencies to understand current weather conditions. Furthermore, they had not been trained and assessed in the skills needed to manage a fast-moving and multi-faceted event such as occurred on the morning of 12 August 2020 (paragraphs 242 to 245).
- 352 The NRWS also provided access to a system which combined forecast rainfall and the current soil moisture tool to give an indication of which slopes might be subject to instability, the Precipitation Analysis Tool. At the time of the accident, the geotechnical asset management team were only using this tool to assess the threat to high-risk earthworks, and it had not been configured to assist the assessment of risk at other locations.

---

<sup>41</sup> In 2019/20, 14% of all failures involved category A earthworks, 20% category B, 24% category C, 27% category D, 8% category E, 7% were not categorised.

353 One of the options listed at paragraph 346 to mitigate the risk of extreme weather was the imposition of temporary speed restrictions in proximity to ‘at risk’ structures and earthworks. Scotland’s Railway had also identified a small number of sections of route adjacent to natural hillsides for the imposition of temporary speed restrictions in case of extreme weather, due to the risk of landslips over substantial lengths of line.<sup>42</sup> However, beyond these known high-risk locations, Network Rail’s processes did not include the option of imposing precautionary speed restrictions in areas subject to forecast, or actual, extreme rainfall events. This meant that although Scotland’s asset managers were well aware of the threat posed by intense rainfall events, such as summer convective storms, neither they nor controllers had any ‘ready-made’ procedural options to mitigate the risk of infrastructure failure in such circumstances.<sup>43</sup>

#### Adequacy of Network Rail’s response to extreme weather

354 The executive leadership team at Network Rail was aware that intense and volatile rainfall events posed a risk to assets that were not subject to special mitigation measures. However, there appeared to be a belief that the newly installed weather forecasting and monitoring tools would provide significant levels of additional protection.

355 In previous decades, the lower prevalence of volatile rainfall events, coupled to the limited capability of rainfall monitoring technology, meant that the potential benefits of a more precautionary approach were likely to have been outweighed by the potential costs of train service disruption. It was also more difficult to implement operating restrictions, such as speed reductions at short notice, in the absence of modern communications technology. However, in more recent years, technological progress makes it possible to track such weather events as they happen and often allows them to be predicted with relatively high confidence a few hours before they occur. For this reason, Network Rail had procured access to weather systems that were capable of providing short-term forecasts and detecting such events in real-time and alerting controllers (via the NRWS). However, although the system went live on 31 August 2015, by August 2020 it had yet to be incorporated into Network Rail’s procedures and controllers had not been trained in its use.

356 RAIB’s findings regarding the sufficiency of Network Rail’s strategy for managing extreme weather events are consistent with those of the Weather Advisory Task Force chaired by Dame Julia Slingo (see paragraph 633). The task force concluded:

*‘The weather alert thresholds, used operationally to mitigate weather-associated risks and manage safe train operations, require a major overhaul. They need to be dynamic in space and time, to be based on multiple predictors and to reflect the variations in exposure and vulnerability across the network.’*

<sup>42</sup> Examples included sections of line on the West Highland line at Loch Treig and Loch Eilt.

<sup>43</sup> Network Rail’s processes did describe an option to impose ‘blanket’ emergency speed restrictions across a broad area without requiring the installation of speed restriction signage. However, this option only related to operation of trains in high winds, or to mitigate the risk of rails buckling in high temperatures. Since the accident, it is also available for heavy rainfall.

357 The task force also reflected on the ability of Network Rail to implement effective measures for the management of weather risk:

*'Weather pervades many aspects of Network Rail's operations, beyond daily weather alerts, and with a diverse range of needs. There does not seem to be a central core of expertise - an 'authoritative voice' - that can be drawn on to ensure that weather science and data are used correctly and coherently across the organisation. There also seemed to be a lack of coherence on the procurement of expert weather and flooding services combined with a lack of knowledge of existing, external capabilities that could be levered rather than procuring something new.'*

358 For the reasons given in paragraphs 345 to 353, there were weaknesses in Network Rail's arrangements for the management of extreme rainfall. Although Network Rail had taken some steps towards implementing modern technology to help monitor weather conditions and better inform operational decision makers, its capability had not been fully exploited before the accident at Carmont. RAIB observes that the roll-out of a technology-based strategy has real potential to manage the risk from extreme rainfall provided those that will rely on it are given suitable procedures and training. Such a strategy, coupled to modern communications equipment, would enable train drivers to be instructed to operate at speeds commensurate with the rainfall-related risk in the locality they are passing through. This would benefit the safety of the line (by restricting train speeds, or suspending operations, when necessary) while reducing the need for imposing blanket speed restrictions over areas that are not at significant risk.

#### Management assurance of Network Rail operational control functions

**359 Network Rail's management assurance processes did not highlight the extent of any areas of weakness in the implementation of extreme weather processes in route controls, or that the controllers lacked the necessary skills and resources to effectively manage complex weather-related situations of the type experienced on 12 August 2020. Consequently, significant areas of weakness in the railway's risk mitigation measures were not fully addressed.**

360 This investigation has identified a number of areas in which the management of the weather events on 11/12 August did not match Network Rail's business processes or expectations. These were:

- a) Contrary to the requirement of Network Rail's standard governing the management of extreme weather events (NR/L2/OPS/021), no extreme weather action team (EWAT) meeting was convened on 11 August despite weather forecasts that exceeded the laid down criteria for triggering such a meeting.
- b) Despite indications that rainfall was sufficiently intense to pose a high risk to the infrastructure, and contrary to the requirement of standard NR/L2/OPS/021, an EWAT meeting was not convened during the night and early morning of 12 August (paragraph 298).
- c) Despite the severity and extent of the disruption on the morning of 12 August no senior management ('gold') incident command structure was established (paragraph 239).



- d) Controllers had not been provided with the tools, training and procedures needed to fully exploit the information available to them via the NRWS (paragraphs 242 to 245).
  - e) Although the NRWS was able to provide real-time information on the location of extreme rainfall, it had not been configured for the purpose of real-time control, and controllers had not been provided with the procedures or training needed to exploit the technology (paragraph 219).
  - f) Route control did not take proactive action based on a holistic view of events when informed of numerous infrastructure failures associated with intense rainfall in the area of the accident (paragraphs 226 to 231).
  - g) Network Rail had not sufficiently developed the route control staff competence to manage complex weather-related situations of the type experienced on 12 August 2020 (paragraphs 226 to 231 and 242 to 245).
- 361 Witness evidence indicates that the management of the railway on the 11/12 August was broadly typical of the way that the Scotland route control responded to extreme weather events. Furthermore, evidence suggests that the use of the new weather technology had not been embedded in other route controls.
- 362 Given the extent of the drift away from Network Rail's corporate expectations in respect of extreme weather management, RAIB has sought to understand why these issues had not been highlighted by the corporate assurance process. This is addressed in the following section.

#### Audits of operational control functions

- 363 Network Rail's audit processes are intended to provide assurance at every level of the organisation that risk management systems are operating as intended.
- 364 'Level 2' audits were designed to provide 'corporate oversight' of Network Rail's core safety management processes. Level 2 audits were focused on particular functions or management systems, were conducted by persons independent from those with the responsibility of implementing the risk controls and were generally performed by Network Rail's central audit team. Since the routes had no audit department of their own, they were reliant on the central team for independent confirmation that mandated processes were being effectively implemented.<sup>44</sup>
- 365 A national level 2 audit issued in September 2013 by Network Rail's Safety and Standards Directorate (S&SD) identified the '*lack of an information technology policy roadmap to identify the most appropriate systems to be adopted to manage extreme weather*' and recommended actions to develop a programme for the development of a 'Future Weather Management System'. This was intended to pull together a wide range of information systems into a single tool to enable the effective management of extreme weather across the network.
- 366 Work continued with the development of a weather management system which led, in 2015, to Network Rail procuring access to the detailed weather data it required to enable short-term forecasting and real-time monitoring of extreme weather events, the NRWS. However, by the time of the Carmont accident this service was not being fully used, and many of the capabilities of the system were unknown to control staff.

<sup>44</sup> At least in Scotland, the route health and safety team undertook some local safety audits which were very unlikely to identify technical shortcomings such as those related to the A&EWP.

- 367 Scotland's Railway routinely reviewed those audits directly relating to the route, or of more general relevance, at its 'business assurance committee'.
- 368 RAIB found no evidence of any level 2 audit that covered the activities of controllers in Scotland. This meant that the limited utilisation of the NRWS, and the fact that the nationally mandated process for the management of extreme weather events was being implemented differently in Scotland, were not highlighted by Network Rail's management assurance process. As a consequence, the Network Rail Board, its SHE committee and the business assurance committee of Scotland's Railway appear to have been unaware of the level of effectiveness of the extreme weather processes or the extent to which modern technology was, or was not, in use to forecast and track intense rainfall.
- 369 In addition to the level 2 assurance process, line managers were required to check that those under their management were applying the mandated processes correctly (one of the level 1 assurance activities). RAIB found that no process existed in relation to assurance checking of the weather management arrangements, or that these routine checks ever looked specifically at weather management, either nationally or in Scotland.

#### *Management awareness of working practices in Scotland's route control*

- 370 The operational response to extreme weather was generally co-ordinated by the head of integrated control and/or the RCM who was on duty at the time. Delivery unit (maintenance) teams provided much of the resource needed to implement the mitigation as directed by control or asset managers. Senior managers, up to and including the managing director, were invited to attend EWATs and would sometimes dial in. Witness evidence suggests that was generally done for information, and senior managers rarely felt it necessary to intervene. On occasions, major decisions such as route closures would be referred to a senior manager for endorsement.
- 371 Witness evidence indicates that the main focus of Network Rail's senior managers during EWATs was to understand the likely impact of any operational mitigation measures and the post-event recovery strategy. They had been confident in the ability of the control managers to apply mandated processes and were apparently unaware of any deficiencies in the process, or the way it was implemented. RAIB has found no evidence of any concerns being raised at any of the senior management meetings about the capability of Network Rail's operational route controls to manage extreme weather events in the way envisaged by the published business processes.
- 372 In the absence of independent audits of control functions, the senior management team was reliant on assurances from the head of integrated control that mandated processes were being effectively implemented. However, no evidence has been found that any issues of concern were ever reported to Scotland's Railway's senior management team. Furthermore, despite occasional engagement with EWATs, none of the senior management team have stated that they observed working practices which they believed to be outside of mandated process.
- 373 RAIB has concluded that the way of working in Scotland's route control had become normalised to the extent that senior managers did not notice the drift from mandated process.

## Risk awareness

**374 The railway industry's risk assessments had clearly signalled that earthwork/drainage failure due to extreme rainfall was a significant threat to the safety of the railway. However, they had not clearly identified potential areas of weakness in the existing operational mitigation measures.**

### Safety decision making in the railway industry

375 The railway industry's safety decision process is recorded in a document developed and issued by RSSB, 'Taking Safe Decisions'. This explains a methodology for assessing whether additional measures need to be implemented to address a known risk, commensurate with legal obligations. This guidance states that railway organisations have a duty to ask themselves whether the risk they are responsible for is being managed 'so far as is reasonably practicable'. This question can be addressed by reference to good industry practice, standards or legal requirements. However, where such benchmarks do not exist it will often be necessary to assess the costs of a new measure against the potential safety benefit by means of a cost-benefit assessment. UK legal precedent provides that where the costs of a safety measure are grossly disproportionate to the safety benefit then there is no legal obligation to implement that measure, even where it is demonstrable that safety will be improved.

### Number of earthwork/drainage failures

376 Drainage systems are an integral part of the earthwork (artificial or natural slope) in which they are situated. Both the cause and consequence (debris deposited on the track) of the Carmont drain washout were similar to washout from a soil slope. Risk control measures provided for earthwork failures of any type would also provide mitigation for debris deposition due to a drain washout. For this reason, it is relevant to examine Network Rail's management of the risk of earthwork failure.

377 The starting place for any risk assessment of earthwork failures is data on the number of earthwork failures. Figure 64 plots the number of failures recorded by Network Rail between January 2006 and August 2020. The blue line plots, for each month, the number of failures in the previous 12 months (for instance, the value shown for July 2007 is the total number of recorded failures from August 2006 to July 2007) and the orange line the rolling mean annual average over the previous five-year period. This figure shows that the frequency of earthwork failures varies considerably year-by-year, as does the weather. However, when viewed over a longer time frame, for instance five years, it can be seen that the average number of failures had risen from about 79 to 131 per year between November 2012 and May 2017. It then fell back to about 100 per year in November 2019 before starting to rise again in the seven months before the accident at Carmont.

378 Data provided to RAIB by ORR indicates that the number of derailments caused by earthwork failures averaged about eight per year between 1994 and 2014. According to this data there were only three such derailments between April 2014 and Dec 2020.

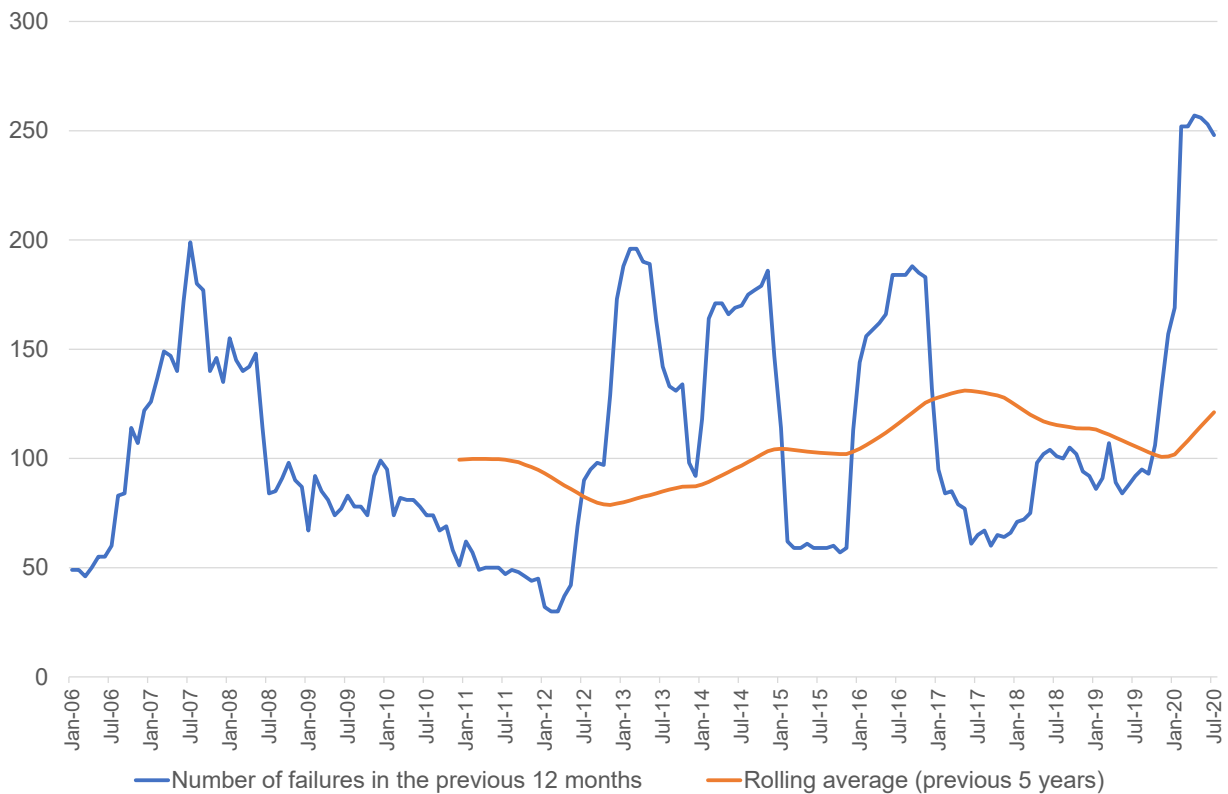

Figure 64: Recorded earthwork failures on Network Rail infrastructure July 2005 to August 2020 (as defined in accordance with Network Rail's standard NR/L3/CIV/185<sup>45</sup>)

379 The variability of the underlying data means that it is inappropriate to conclude that the statistical fall between June 2017 and November 2019 was evidence that the underlying long-term risk was actually falling. Consideration of a time frame longer than five years indicates a gradual increase in the number of earthwork failures over the last decade. This is likely to be a more representative picture of earthwork risk but the variability of failure data, and the relatively short time frame for which it is available, means it is not possible to draw a definitive conclusion based only on this data: it is also possible that part of the increase is due to improved reporting of earthwork failures. These shortcomings can be largely overcome by recognising the correlation between earthwork failures and rainfall, for which large amounts of historical data and long term forecasts are available (see paragraph 387).

### Risk assessment

380 Network Rail assessed the underlying residual safety risk from operation and maintenance using a tool known as the Safety Risk Model (SRM) developed by RSSB. The model is only updated occasionally and the version that was current at the time of the accident (v8.5.0.2) was based on data up to 28 February 2017. The output of the model is an estimate of overall harm, expressed as average fatalities and weighted injuries (FWI) per year.

<sup>45</sup> NR/L3/CIV/185 issue 1 published September 2017: 'Management of Reports of Safety Related Geotechnical Incidents'.

- 381 Based on historical data on earthwork failures and assessments of their potential consequences, the SRM estimated the overall risk associated with earthwork failures to be 0.302 FWI per year (equivalent to one fatality every 3.3 years). This could be viewed as a pessimistic assessment of the risk given that there have been no fatalities as a direct result of trains hitting landslips in the last 60 years.<sup>46</sup> This apparent pessimism arises because the SRM allows for very severe multi-fatality accidents that are likely to occur very rarely. The SRM estimated the risk associated with earthworks failure (0.302 FWI per year) to be 5% of the total risk from train accidents and 31.4% of the total risk from derailment (from all causes). The contribution of drainage assets to this data has not been quantified, but historical data trends show that a high proportion of earthwork failures are associated with drainage issues.
- 382 The SRM identified three precursors to passenger train derailment and the average national frequency for each. These were:
- embankment failure (0.333 events per year)
  - soil cutting failure (0.554 events per year)
  - rock cutting failure (0.22 events per year).
- Combined, these precursors resulted in an average of 1.1 passenger train derailments per year.
- 383 The SRM was not designed to model the frequency of different types of the failure mode. This means that the model provides no insight as to risk associated with the different causes of earthwork failure, or the contribution of extreme rainfall and drainage events to the overall risk. Furthermore, since the SRM is only updated every few years, it has not provided a means for railway duty holders to monitor how risk is changing from one year to the next, or how it changes throughout the year. It was for this reason that RSSB, working closely with Network Rail, developed the Precursor Indicator Model (PIM).
- 384 The PIM is based on a record of precursor events associated with high-risk train accidents, including derailment. The potential risk posed by each of these events is then estimated to generate an overall assessment of risk in each four-week period. Although the PIM does not provide an absolute assessment of underlying risk, it is a powerful tool which enables managers to see how risk is changing over much shorter periods of time than is possible with the SRM. In the case of earthworks, it also enabled Network Rail to plot the risk from earthwork failure in each month correlated with the amount and intensity of rainfall.
- 385 According to the PIM data provided by RSSB, the FWI/year associated with failures of earthworks in 2016/17 was 0.30 (table 4, and figures 65 and 66). In 2018/19, the estimate of FWI/year had risen to 0.53. In 2019/20 the estimated FWI/year had risen to 1.28, driven by the number and severity of storms during 2019/20 that resulted in earthwork failures (figure 67). This meant that earthwork failure now accounted for 27% of all train accident risk and about 60% of the train accident risk associated with asset integrity.

---

<sup>46</sup> The fatality associated with the Ais Gill landslip in 1995 occurred when a member of staff alighted from their train and was then struck by another train.

	Number of failures reported to the PIM		PIM risk weighted indication of safety performance (FWI/year)		
	Embankment failures	Cutting failures	Embankment failures	Cutting Failures	Total
2016/2017	17	67	0.0879	0.216	0.30
2017/2018	22	54	0.107	0.169	0.28
2018/2019	37	71	0.241	0.292	0.53
2019/2020	61	190	0.486	0.791	1.28

Table 4: Outputs from the Precursor Indicator Model (PIM) 2016/17 to 2019/20 (RSSB)

Earthworks PIM Control Chart - One Period In Arrears

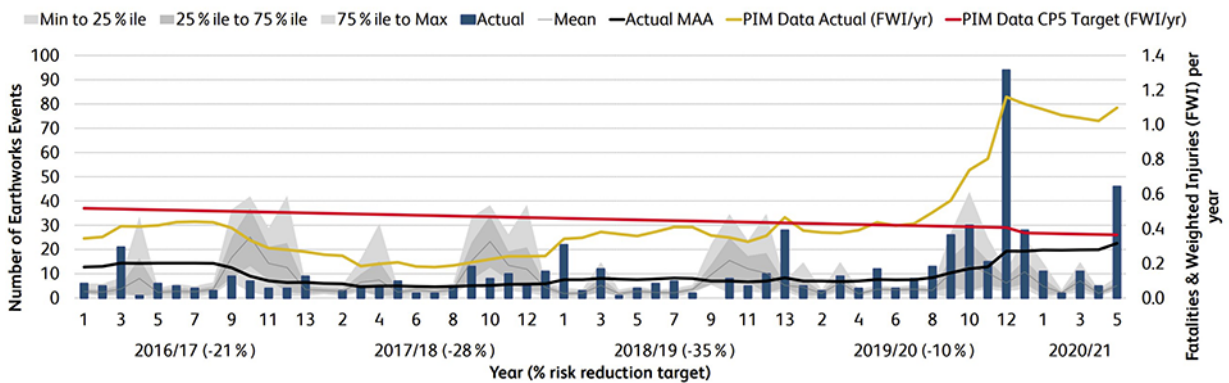

Figure 65: Earthworks PIM 2016/17 to 2020/21 (Extract from Network Rail’s Safety, Health and Environment Performance report for period 6 of 2021/22)

386 Although the PIM is a useful aid to understanding the risk of earthwork failure, it does not provide any detailed insight as to the various failure modes. By way of example, the PIM does not provide data on the frequency and risk of events associated with failures of drainage to perform as designed. However, the earthworks failure data that informs the PIM, which is provided by Network Rail’s geotechnical team, includes more detail of failure modes.

387 At first sight, the presentation of the PIM data in figures 65 and 66 might suggest that the risk from earthwork failures only started to rise in April 2018. However, since this risk is closely linked to the variability of the weather, it is important that risk management decisions are based on a longer view of changes in risk. The earthwork failure data at figure 64 shows that the five-year rolling mean average number of earthwork failures has been gradually rising over the last decade. Furthermore, rainfall data collected over the last 160 years suggests an increase in the UK’s average annual rainfall since the 1980s (figure 68). Since rainfall is closely linked to the risk of earthwork failure, it is likely that the underlying risk of earthwork failure has been rising for some considerable time.

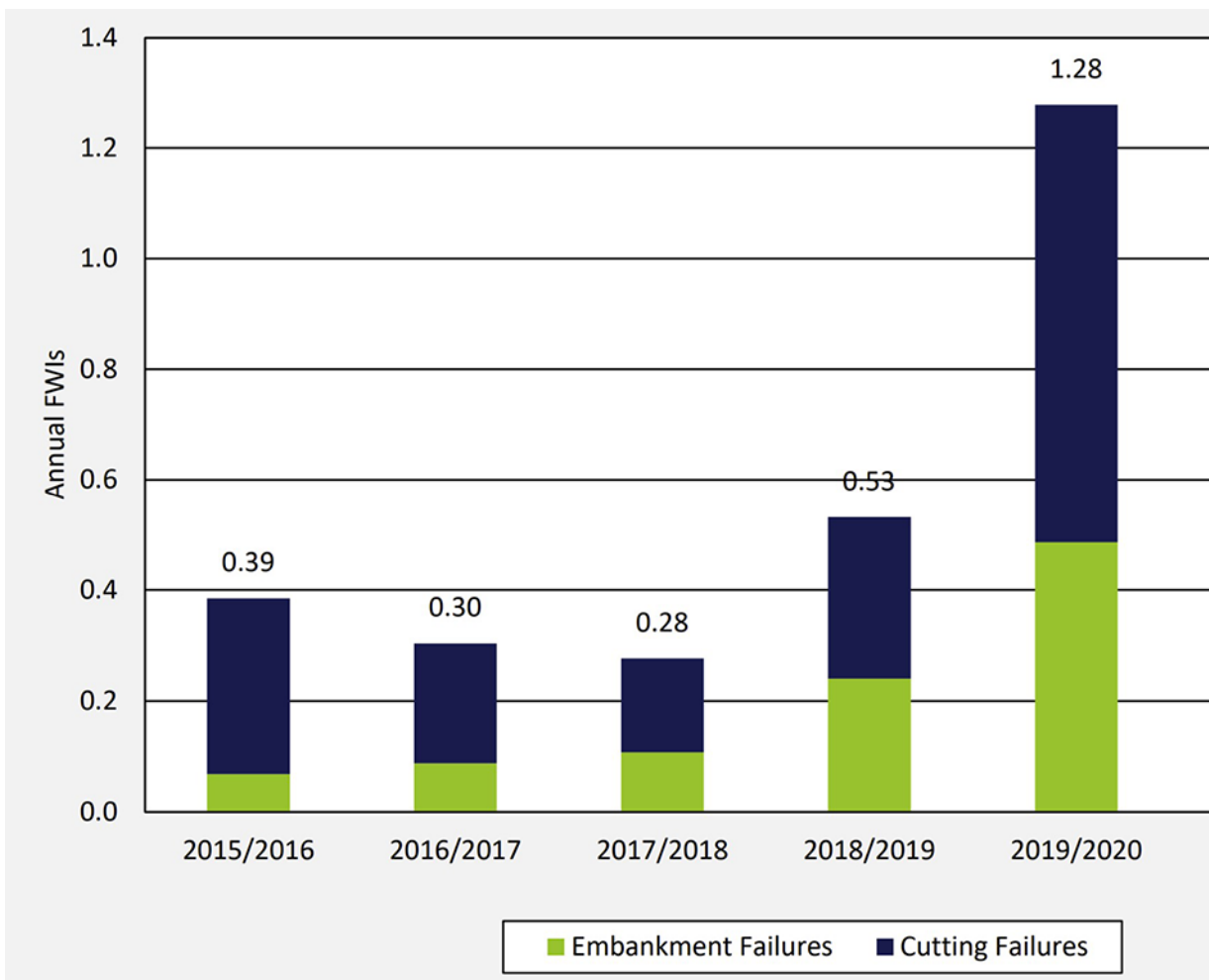

Figure 66: Train accident risk from earthwork failures 2016 to 2020 (RSSB)

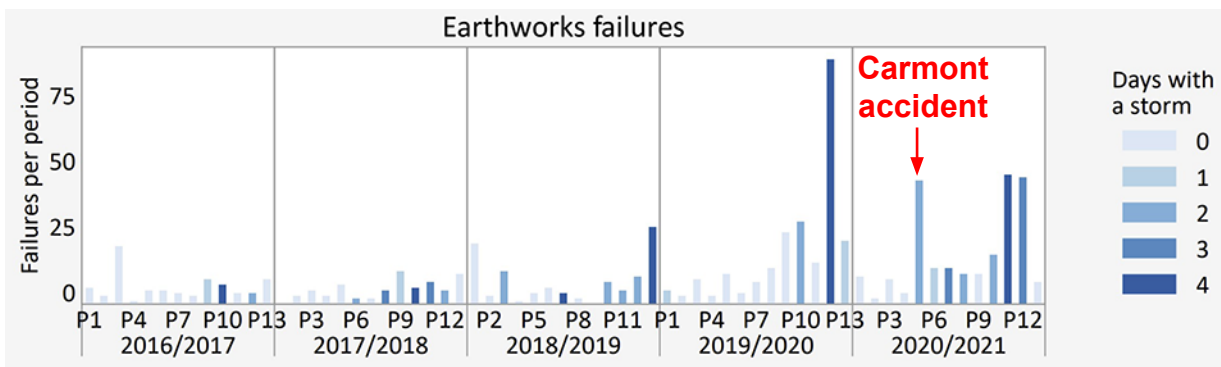
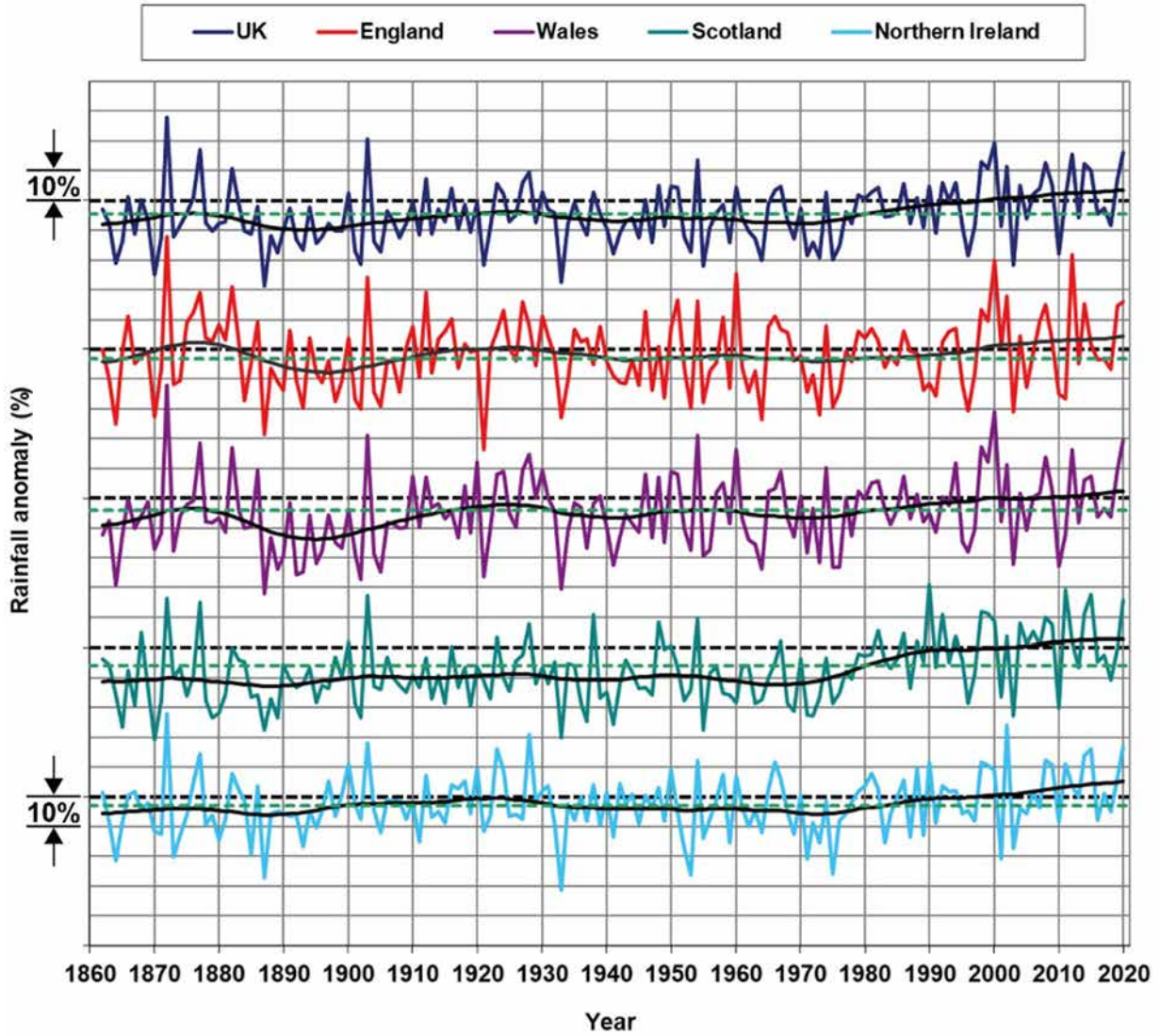

Figure 67: Earthwork failures and storm days plotted against time (RSSB)



Area	1961–1990 average	1981–2010 average	2011–2020 average	2020
UK	1,099	1,150	1,197	1,336
England	827	853	891	989
Wales	1,405	1,463	1,496	1,747
Scotland	1,471	1,563	1,627	1,810
Northern Ireland	1,102	1,136	1,199	1,324

Figure 68: Annual rainfall in UK and nations, 1862-2020, expressed as a percentage of 1981-2010 average with the 1961-1990 average shown by the dashed green line and the 1981-2010 average shown by the dashed black line. The table provides average annual rainfall (mm). Source: Kendon et al. (2020)



388 RAIB concludes that the PIM data presented in the SHEP report is heavily influenced by short-term changes in the weather conditions (which was acknowledged in the SHEP reports). This creates a potential that one or two relatively dry winters will be perceived as evidence that the risk of earthwork failure is less significant than it really is. In reality the underlying level of risk appears to have been steadily growing as the mean average rainfall in the UK increases.

### Engineering risk analysis

389 Since Network Rail had recognised the risk associated with earthwork failures, it put in place a range of processes to manage the risk. These include regular examinations and evaluations to identify areas of potential weakness and deterioration. These evaluations provided the basic information needed to quantify the likelihood of an earthwork failure at a particular location, and the impact of the consequences should it occur. These quantified assessments, combined with the expert judgement of engineers, are used to plot the risk of each earthwork on an Earthworks Safety Risk Matrix. This matrix enables Network Rail to identify earthworks of particular risk, such as earthworks that are more likely to fail in such a way that the safety of trains is endangered.

390 In order to develop its policy in relation to earthworks and drainage, Network Rail (S&SD/STE) undertook a series of 'bowtie' analyses in conjunction with the professional heads and their teams. The 'bowtie' methodology is used to analyse and display causal relationships (the method takes its name from the shape of the diagram that is created, which looks like a bowtie, see figure 69). The diagram is used to identify:

- on the left-hand side, the potential causes of a particular threat materialising and the associated preventative measures that have been established
- on the right-hand side, the potential consequences/impact and the associated mitigations.

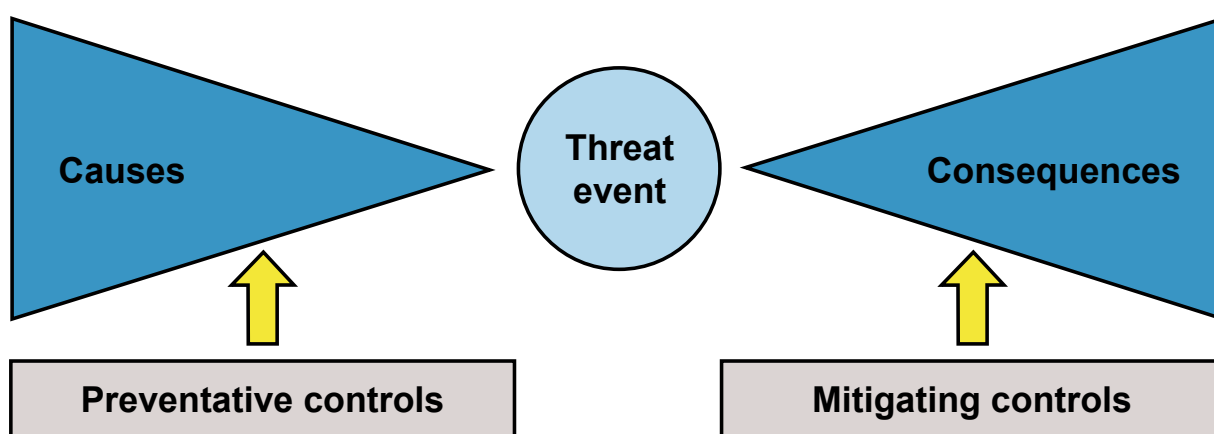

Figure 69: Bowtie methodology for assessing threats

391 Network Rail has developed a bowtie to cover the threat of earthwork failure, and another to cover the threat of loss of drainage function or capacity. In both cases, the left-hand side of the diagram defines various types of failure mechanisms (threats) and the processes that are in place to reduce the likelihood of this occurring (barriers), and the right-hand side shows the controls that are in place to manage the consequences should the threat materialise.

- 392 An examination of the bowtie for drainage is of particular relevance to this investigation. The version that applied at the time of the accident (A01) was issued in September 2019. It reveals that Network Rail had recognised the risk that extreme rainfall could overwhelm a drainage system and had identified a range of preventative controls, including the application of Network Rail standards governing the design and installation of drainage. The importance of asset management was also recognised with reference to standards governing drainage asset knowledge, inspection and maintenance.<sup>47</sup>
- 393 On the right-hand side of the drainage bowtie diagram, Network Rail had identified the mitigating controls that would apply should a failure of drainage result in sufficient damage to infrastructure to derail a train. The most important of these mitigations was described as ‘operation control’ (that is measures to restrict/prevent the movement of trains during extreme rainfall events). However, no detail was provided on the nature of these operational measures, when they would be applied, how they should be managed or the ways in which they might fail. Nevertheless, the effectiveness of the ‘operation control’ mitigation was assessed to be ‘optimal’. According to Network Rail’s definition, a control is defined as ‘optimal’ if the following statement is true:
- ‘Control and mitigating actions are reasonably practicable, comprehensive and commensurate with the risk and are evidenced as working as intended.’*
- 394 Other mitigating controls identified by Network Rail included monitoring equipment to detect infrastructure failure (assessed as ‘inadequate’) and reporting by train drivers, other railway staff and engineering staff (assessed as ‘adequate’).
- 395 RAIB has also reviewed the mitigating controls that were identified in the bowtie diagram for earthworks failures. These refer to ‘operational restrictions’, which were assessed as being ‘reliable’.
- 396 Overall, RAIB has found no evidence that Network Rail assessed the risk of a failure of its operational controls in case of extreme rainfall, or systematically evaluated their effectiveness or completeness. As a consequence, it did not trigger appropriate action to address gaps in its processes or additional operational controls made possible by advances in technology.

### Corporate learning

**397 Despite an awareness of the risk, Network Rail had not completed the implementation of additional control measures following previous events involving extreme weather and the management of operating incidents. It is possible that better delivery of change in response to safety learning would have resulted in actions that would have prevented, or mitigated, the consequences of the accident at Carmont.**

### Previous earthwork and weather-related events

- 398 Precursor events during the 10 years before the Carmont accident provided Network Rail with clear evidence of the risk associated with earthwork drainage.

<sup>47</sup> Although not considered relevant to the cause of the drainage failure at Carmont, the effectiveness of all these controls was assessed as being ‘inadequate’.

399 Including Carmont, RAIB has investigated 11 earthwork failures resulting in debris being deposited on the railway in circumstances with significant similarities to those causing the washout at Carmont (table 5). All were triggered by rainfall and most involve drainage issues and/or surface flows being concentrated into small areas of an earthwork. These characteristics apply to failures occurring within and outside the railway boundary. Earthwork failures triggered by construction work, vegetation and melting snow have insufficient similarity with the Carmont situation to be included in the table. The tabulated events demonstrate:

- the potential for events to occur at locations where examinations had not identified a high risk of failure (7 of the 10 events for which records were obtained)
- the likelihood of rain, particularly heavy rainfall, triggering the event - a rainfall return period of one year or more in 6 of the 8 events for which return periods were obtained
- the importance of providing an effective drainage system (7 of the 11 events involved inadequate drainage systems).

<b>Location of accident</b>	<b>Date of accident</b>	<b>Rainfall return period (approx.)</b>	<b>Earthwork condition (likelihood of failure)*</b>	<b>Nearby feature potentially increasing consequences</b>	<b>Notes</b>
Oubeck North	Nov 2005	Not known	Not known	Bridge	Drainage not maintained
Gillingham	Nov 2009	Not known	Poor	Tunnel entrance	Blocked drain
Clarborough	Apr 2012	Not known	Marginal	Train was exiting a tunnel	Blocked drain
Loch Treig	Jun 2012	1 year	Marginal	Steep downward slope alongside railway (natural slope)	Failure of natural slope
Falls of Cruachan	Jul 2012	< 1 year	Marginal	Steep downward slope beside railway (natural slope)	Blocked drain (blockage outside railway boundary)
Rosyth	Jul 2012	3 years	Serviceable	None	-
St Bees	Aug 2012	57 years	Marginal <sup>##</sup>	Steep downward slope beside railway (natural slope)	Water concentration feature
Bargoed	Jan 2013	7 years	Poor (remedial work in progress)	Steep downward slope alongside railway (natural slope)	-
Watford tunnel	Sept 2016	42 years	B <sup>@</sup>	Tunnel	Water concentration feature Drainage not maintained

<b>Location of accident</b>	<b>Date of accident</b>	<b>Rainfall return period (approx.)</b>	<b>Earthwork condition (likelihood of failure)*</b>	<b>Nearby feature potentially increasing consequences</b>	<b>Notes</b>
Corby	June 2019	< 1 year	Marginal	None	Blocked stream outside railway boundary
Carmont	Aug 2020	100 years 144 years #	C (upper part of cutting)  B (lower part of cutting)	Steep downward slope beside railway (embankment)  Bridge	Water concentration feature  Drainage not constructed in accordance with design
<p>* Earthwork condition on scale from 'A' (statistically least likely to fail) to 'E' (statistically most likely to fail) or, for earlier examinations, on scale of serviceable, marginal and poor.</p> <p>## Outcome of post-accident review of data collected pre-accident. The pre-accident assessment was satisfactory, a difference which had no relevance to the accident.</p> <p>@ Remedial works in progress in area of washout so B is unlikely to reflect conditions in this area. It is likely that the B classification refers to the adjacent earthwork above the tunnel portal.</p> <p># 1:100 years based on 2013 methodology, 1 in 144 years using 1999 methodology (paragraph 102)</p>					

Table 5: Summary of earthwork failures investigated by RAIB

400 As shown by table 6, RAIB's findings are consistent with Network Rail data demonstrating that, in the period 2015 to 2020, 65% of earthwork failures nationwide, and 72% of failures in Scotland, occurred at locations assessed as being at relatively low risk of failure (hazard categories A to C). Only 5.2% of failures nationally, and 1.5% of failures in Scotland, occurred in slopes in the highest hazard category (E).

	<b>Earthwork hazard category</b>					<b>Unclassified</b>	<b>Not recorded</b>
	<b>A (least likely to fail)</b>	<b>B</b>	<b>C</b>	<b>D</b>	<b>E (most likely to fail)</b>		
Failures on all routes	166	189	255	183	49	55	39
Failures on Scotland's Railway	27	23	47	26	2	4	5
Network total as proportion of earthworks in that category on 15/01/21 (%)	0.17	0.4	0.67	2.36	5.04	17.63	

Table 6: Earthwork failures April 2014 to January 2021 recorded by Network Rail using criteria contained in standard NR/L3/CIV/028 until 2017 and then standard NR/L3/CIV/185

401 Earthwork failures (including those involving drainage) are usually related to periods of heavy rainfall. The correlation is apparent in figures 70 and 71 but is stronger than these plots suggest as the rainfall data is a nationwide monthly average, and so does not fully reflect a few days of very heavy rain and/or heavy rain limited to only part of Great Britain. The need for mitigation at earthwork locations is not dependent on recognising the precise mechanism for endangering the railway. As at Carmont, this is often impractical, so safe railway operation depends on recognising that extreme weather can result in unpredictable events at locations not previously considered to present a high risk.

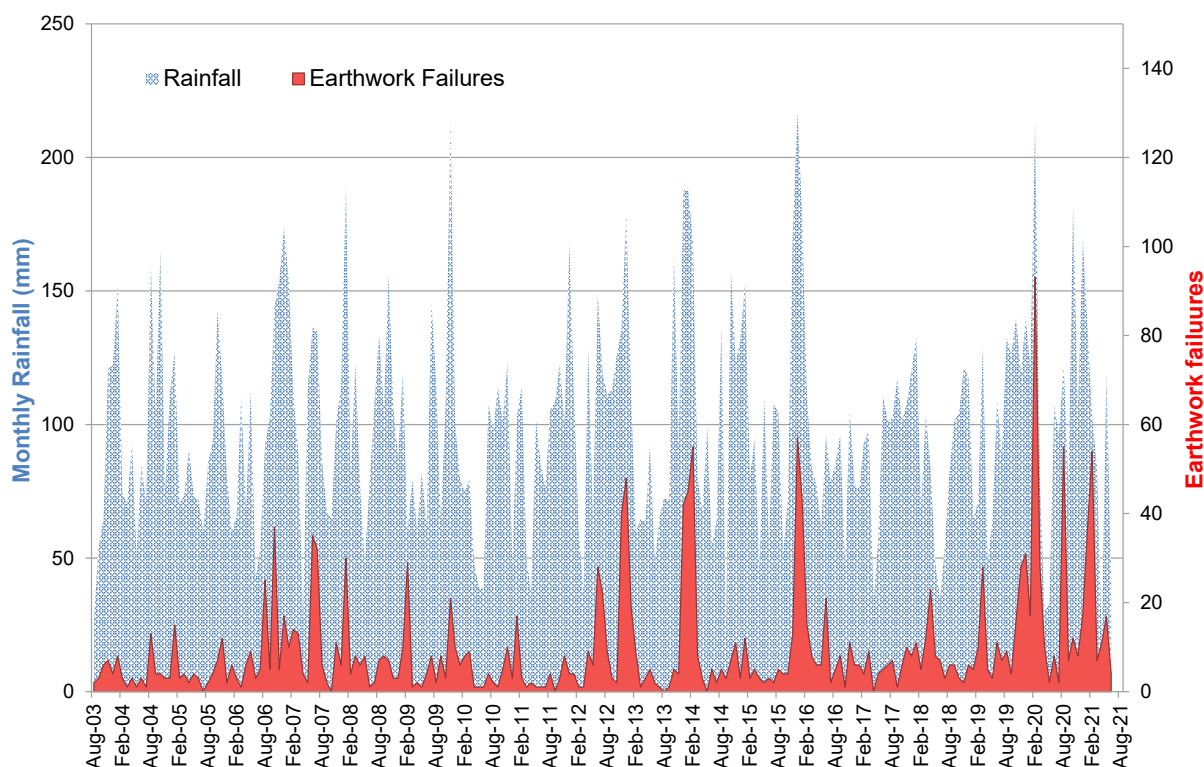

Figure 70: Timeline of earthworks failures and rainfall 2015 to 2020 (Network Rail NR/L3/CIV/185 failures and Met Office national average rainfall data (<https://www.metoffice.gov.uk/pub/data/weather/uk/climate/datasets/Rainfall/date/UK.txt>))

402 The need to mitigate against the effects of extreme weather is not limited to earthworks, as demonstrated at Lamington viaduct on 31 December 2015. In this instance, high flows in the River Clyde caused scour at the base of a viaduct pier, resulting in serious deformation of the track as a train travelled over it at 110 mph (177 km/h). Fortunately, the train did not derail and there were no injuries. The event followed an exceptionally wet December in which flow from the River Clyde into the sea was 249% of the December average measured between 1971 and 2000.

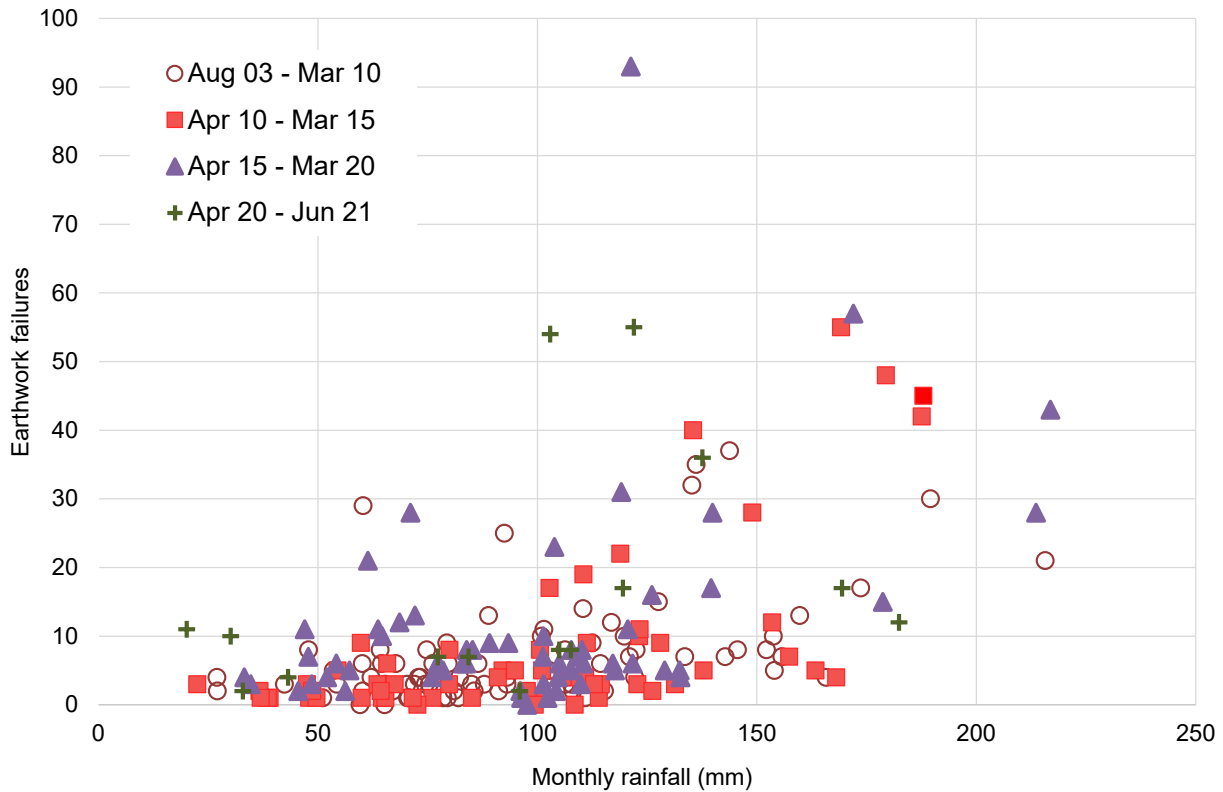

Figure 71: Relationship between earthwork failures and rainfall, 2015 to 2020 (data sources as figure 70)

403 The resulting RAIB investigation ([RAIB report 22/2016](#)) found technical and organisational shortcomings in the flood action procedure (the relevant part of the A&EWP). This plan was intended to use flood warnings as triggers for implementing measures to monitor structures at risk of scour, including Lamington viaduct, and to stop trains using them when necessary. The shortcomings directly relevant to Scotland included:

- route control staff not using the document describing the flood action procedure; most were unaware of it, and it had not been in use for many years
- the absence of effective periodic checks on the flood action plan meant that the lack of a mechanism to provide route control staff with flood warnings was not revealed
- over 100 other structures at risk of scour were affected by the same issues.

404 The combination of factors seen at Carmont relating to route control activities and management of extreme weather were brought together on 16 September 2016 in a cutting at the entrance to a tunnel near Watford. Local topography in an area outside the railway boundary concentrated water onto a small part of a cutting where it washed material onto the track, causing a train to derail as it was entering a tunnel. The derailed train, carrying about 37 people, was struck in the tunnel by a train approaching in the opposite direction with about 242 people on board.

405 It is highly likely that a multi-fatality accident was only avoided because the derailed train was kept close to its own track by equipment on the underneath of the train,<sup>48</sup> and the speed of the approaching train had been reduced from 79 mph (127 km/h) to 34 mph (55 km/h) in response to an emergency radio message sent by the driver of the derailed train. A similar accident at the same location in February 1940 had caused the death of a passenger and resulted in installation of improved drainage. However, Network Rail was no longer aware of this drainage, had not maintained it and it was no longer functional.

406 Similarities between the accidents at Carmont and Watford are apparent in this extract from paragraphs 116 and 118 of RAIB's report on the Watford accident:

*For the four-hour period between 02:45 hrs and 06:45 hrs, the weather radar data indicates that 50.7 mm of rain fell. This was equivalent to a storm with a 1 in 42-year return period at Watford for this period... This rainfall was a summer convective storm. These can be very intense and difficult to predict accurately. Although control staff had access to real time radar via the Network Rail Weather Service, they did not, and were not required to, make use of this information as part of the EWAT process.*

### RAIB extreme weather and earthwork recommendations

407 It is possible that more effective implementation of three RAIB recommendations, addressed to Network Rail, would have at least mitigated, if not prevented, the accident at Carmont. Two of the recommendations related to RAIB's 'class' (thematic) investigation into landslips (published in 2014) and the other relates to RAIB's investigation into the partial failure of the viaduct at Lamington (published in 2016).

408 ORR reviews actions taken by the 'end-implementers' in response to RAIB recommendations, and decides whether they should be considered to be implemented based on information provided. The three relevant recommendations, and the information provided by Network Rail to explain the actions taken in response, are summarised below, together with the shortcomings revealed by the Carmont accident. The full recommendation text and relevant extracts of information provided by Network Rail are given in appendix K.

### Landslips class investigation - Recommendation 3

409 The need to recognise when rainfall presents a risk to railway safety was covered by recommendation 3 of the RAIB Landslips class investigation ([RAIB report 08/2014](#)). This stated that:

*'Network Rail should implement a process for real-time collection (and appropriate use of) intelligence about very unusual rainfall or flooding conditions....'*

<sup>48</sup> The equipment was part of the traction drive system and was not intended to provide such restraint.

410 Network Rail provided the following information to ORR on 15 December 2015 to explain how it had implemented the recommendation:

*'As of the 1st of October 2015 Network Rail has procured a more advanced weather system capability with the ability to utilise actual rainfall data...Current feeds of data being gathered for rainfall are...Forecast [details of 10 day, 5 day and hourly forecasts are given]...Live data and observations [details of 6 hour and 1 hour precipitation are given]...The current technology now allows Network Rail to better predict areas of concern for individual hazards but also act on hazards which may have occurred which were not predicted. Applying this additional intelligence into well a (sic) practiced (sic) incident management approach leaves us in a far better position in terms of risk management for unusual and weather conditions which were not forecast... briefed to key Network Rail and Industry staff for use in operational environments with configurable alert functions available for rainfall and all other weather related hazards.'*

411 RAIB's investigation of the Carmont accident found that Scotland's route controllers had not been trained how to manage the risk of intense rainfall using this weather forecasting and monitoring capability and its configurable functions.

412 Although the words '**briefed to key Network Rail and Industry staff**' suggested that RAIB's recommendation had been implemented, this was not actually the case. Network Rail stated after the Carmont accident that the recommendation had been closed '**based on a review by the Network Rail national control manager and national weather specialist to consider how a new process of real time collection of intelligence about rainfall could be implemented**' (RAIB emphasis).

### Lamington - Recommendation 3

413 Processes needed to trigger appropriate mitigation following an extreme weather event are covered by recommendation 3 of RAIB's Lamington investigation ([RAIB report 22/2016](#)) which stated:

*'Network Rail should review and improve the management and assurance systems for all control centre processes relating to the safety of railway infrastructure used by Scotland Route. The review should encompass both documented processes and the way they are implemented. It should include... procedures directly relevant to control room staff...inputs required from external organisations.'*

414 On 3 December 2019, Network Rail wrote to ORR explaining implementation of the recommendation. Network Rail argued that it had implemented the recommendation by updating its national standards for weather management. It also stated that:

*'Scotland continue to use their updated weather plan to manage extreme weather response, which include responding to structural issues. Work has taken place with the route to map their scour and structure risk sites on the Network Rail Weather Service, which will provide email alerts when pre-agreed thresholds are met. This is a piece of work that is being undertaken by a number of other routes with our forecasting partners, MetDesk.'*



415 No evidence was provided as to how Network Rail had assured itself as to the adequacy of Scotland's weather management processes. However, whether or not such a check was ever carried out, it is evident that the gap between national standards, and Scotland's operating practices had not been properly addressed. Since this gap had started to emerge from around 2012, when the number of EWATs in Scotland started to dramatically reduce, it could have been spotted had adequate checks been carried out in line with the expectation of RAIB's recommendation.

#### Landslips class investigation - Recommendation 5

416 RAIB's Landslips class investigation ([RAIB report 08/2014](#)) recognised that enhanced earthwork mitigation was required for very extreme weather conditions. Recommendation 5 of this investigation stated:

*'Network Rail should formalise the process for implementing additional mitigation if very extreme rainfall conditions mean that the mitigation normally provided in response to a red warning is inadequate for earthworks on the 'at risk' register and/or there is a significant likelihood of landslips at locations not included on this register.'*

417 Network Rail's explanation for stating that this recommendation had been implemented was provided to ORR on 6 July 2016. This stated that a dynamic risk assessment process had been introduced to cover unpredicted changes to weather conditions as part of the operational weather management standard (NR/L2/OCS/021), and that this allowed for the impact of weather on assets that are not listed as being 'at risk'.

418 Network Rail's submission to ORR also included the following extracts from NR/L2/OCS/021 (page 10 of the version published on 6 March 2016 and valid when the justification was provided by Network Rail on 6 July 2016):

*'Route Asset Managers shall:*

- a) Prepare and communicate Route and local adverse and extreme weather plans in accordance with NR/L2/CIV/086-4 and NR/L3/TRK/1010 respectively.*
- b) Distribute asset-specific response guidance based on the weather hazard and its impact on specific assets.'*

419 Module 4 of NR/L2/CIV/086 covers maintenance, repair and refurbishment of earthworks rather than extreme weather mitigation. Module 9 of NR/L2/CIV/086 was first published on 2 September 2017 with a compliance date of 31 December 2017 and remained valid on 12 August 2020. This dealt with adverse/extreme weather, but only for earthworks 'at risk'. Earthwork-related issues covered by NR/L3/TRK/1010 are also limited to 'at risk' earthworks. This means that Network Rail's justification for closure of the recommendation does not actually address earthworks not on the 'at risk' list, but this is only apparent by referring to the referenced documents. However, a reference to dynamic risk assessment for earthworks not on the 'at risk' list was included in module 8 of NR/L3/OPS/021 when this was published in June 2019 with a compliance date of 7 September 2019, three years after Network Rail's response to ORR (paragraph 417).

420 The actions taken on 11 and 12 August 2020 included the geotechnical asset management team monitoring rainfall, an action which would be part of an effective dynamic risk assessment process. However, although the risk to earthworks not on the 'at risk' list had been recognised, there is no evidence that action would be taken to mitigate this risk when it was triggered by rainfall alone. In reality, an actual earthworks or drainage event would have been needed to trigger mitigation (paragraphs 345 to 353). This is certainly the expectation of the route control staff, as evidenced in the email extract quoted at paragraph 211.

421 Network Rail's recommendation system contains an entry made during 2014 (the exact date is uncertain) relating to Landslips Recommendation 5. A copy of this entry was provided to RAIB after the Carmont accident and explicitly notes:

*'This recommendation has been interpreted to relate to real time monitoring of rainfall to facilitate rapid responses to control the dynamic risk posed by short, high intensity showers...in such circumstances the baseline mitigation may need to be supplemented...closure [of the recommendation] requires new weather response process to be fully deployed in Routes'*

422 It is therefore clear that, when progressing this recommendation in 2014/15, Network Rail staff understood the need for real-time rainfall monitoring to assess the need for mitigation at earthworks other than those on the 'at risk' list.

### Route control management

423 RAIB has investigated a number of events involving the operational management of incidents by route control functions. These are summarised in the following paragraphs.

#### Lewisham

424 On the evening of 2 March 2018, in the Lewisham area of London, some passengers on several trains alighted onto the track in an uncontrolled manner, with a few possibly doing so while the conductor rail was still energised ([RAIB report 02/2019](#)). These trains had been stationary for considerable periods of time because ice on a conductor rail prevented another train from obtaining the power it needed to move. The area was overseen by the Kent integrated control centre (route control) staffed by people from both Network Rail and Southeastern, the operator of most passenger services in the area.

425 Opportunities to keep other trains moving around the train which was unable to take power were missed as a result of factors including the following:

- Other members of route control staff did not inform the incident controller, also in the control room, about relevant information obtained from telephone conversations with staff directly involved in the incident.
- Information systems available in the control room were not used by route control staff to recognise the extent of the incident.

- Although the trains were stationary for a significant period of time, they were not formally declared as 'stranded' so contingency plans, required for stranded trains by Network Rail and Southeastern operating procedures, were not developed and implemented in a timely manner. These could have included moving trains using emergency procedures, earlier deployment of additional railway staff to assist on-train management of passengers, and better engagement with the emergency services who assisted passenger management on site.
- Roles and responsibilities of relevant staff were not clearly defined in relevant procedures.

426 RAIB investigations into both the Lewisham and Carmont events revealed significant shortcomings in the use of available information technology and the ability of controllers to respond effectively to a complex, widespread and fast-changing incident. Furthermore, both investigations identified significant issues with route control documented processes.

### Baildon

427 On 7 June 2016, a heavy localised shower resulted in water washing away ballast from beneath the track at Baildon, West Yorkshire, after a culvert passing beneath the railway was unable to carry the runoff from surrounding land ([RAIB report 03/2017](#)). Shortly before this, 17 mm of rainfall was recorded in a 30-minute period at a weather station approximately 1.6 km (1 mile) west of Baildon railway station, but no rainfall was recorded throughout the day at two other weather stations within 1.6 km (1 mile) to the south of the railway.

428 Three trains ran over the washout despite Network Rail incident controllers receiving two reports of the event originating from members of the public. The incident controllers did not correctly identify from these reports that there was significant track damage. Network Rail staff investigating the reports did not go to the appropriate locations, partly because the controllers did not make best use of available information when directing these staff. An opportunity to stop one of the trains was missed because an incident controller did not initiate an emergency stop message on the GSM-R system, something for which Network Rail had provided them with initial training but had not maintained their competency.

429 This incident also demonstrates that some parts of Network Rail were aware that detailed weather forecast systems were available to mitigate weather-related risk. The site was being used for a prototype weather alert system which correctly forecast the intense rain about 30 minutes before it occurred. As alert thresholds (amounts of rain at which mitigation was required) had not been established, no alert was sent to the control room.

430 The need for route control staff to receive and make effective use of the information available to them is a theme in both the Baildon and Carmont reports.

## Corby

431 RAIB's investigation of an incident at Corby, Northamptonshire, on 13 June 2019 found another instance in which route control staff were not receiving data from monitoring equipment intended to identify when railway safety was at risk due to flooding ([RAIB report 04/2020](#)). Although not a cause of the June 2019 incident, it is possible that appropriate use of this data would have prevented an accident in other circumstances. RAIB did not make a recommendation on this topic as the data was made available to route control staff after the June 2019 incident. The overlap between use of technology (water level monitoring at Corby and rainfall monitoring at Carmont) means that the Corby findings support the need for a broadly based route control room recommendation.

## Dock Junction/Kentish Town

432 The need for controllers to take appropriate action was demonstrated on 26 May 2011 when trains became stranded between Dock Junction and Kentish Town, London ([RAIB report 07/2012](#)). A train lost traction power and had been stationary for about two and a half hours when it began moving, with the driver unaware that some passengers had alighted in an uncontrolled manner onto the track.

433 The service was being operated by First Capital Connect whose controllers were not aware of, and so did not apply, the contents of the company's stranded train policy. This required evacuation of passengers from trains to be considered within 60 minutes of a train becoming stranded and commencement of evacuation within 90 minutes. Although the stranded train procedures differed between this incident and the Carmont accident, the ineffective application of stranded train procedures is common to both events.

## Discussion

434 Shortcomings in both the documentation and application of route control procedures were present in all of the above incidents investigated by RAIB. Taken together, they reveal the importance of effective decision making and incident management skills in railway control rooms, and the need to ensure that controllers have appropriate experience and knowledge, along with clearly defined responsibilities and accountabilities. The extent to which these issues overlap findings from the Carmont investigation has led RAIB to a broad recommendation concerning both staffing and equipping of control rooms.

## Other rail events

435 A derailment on 28 December 2010 in Summit tunnel, near Todmorden, West Yorkshire ([RAIB report 16/2011](#)), relates to route proving and so is relevant to the observation at paragraph 566. The train involved was a passenger train operating at normal speeds despite being the first train after a period of three very cold days when no train services had operated. The derailment was caused by a pile of ice which had fallen into the tunnel from a ventilation shaft, a risk which had not been identified, and so was not mitigated by route proving, or by other means, before normal train services resumed.

- 436 In addition to learning from events affecting its own infrastructure, Network Rail had the opportunity to learn from events on other railway systems. The operation of a Northern Ireland Railways train over a washed-out embankment near Knockmore, Northern Ireland, on 28 June 2012 is a good example ([RAIB report 14/2013](#)). A passenger train ran over a 10-metre long section of track which was unsupported because an embankment had been washed away. This was the first train to operate after exceptionally heavy rainfall during the preceding night, but no precautions were taken to manage the risk of infrastructure damage due to the weather.
- 437 Underlying factors included Northern Ireland Railways not being aware of the potential for heavy rainfall to cause flooding in this area, and its weather preparedness procedure not including a plan for flooding or heavy rainfall events. Although Network Rail procedures in place at the time of the Carmont investigation addressed some of the shortcomings identified in Northern Ireland Railways procedures, incomplete understanding of the mitigation required for risk from heavy rain are present in both events.

#### Learning from other industries

- 438 Recent technological developments, such as availability of real-time data and improved communications, and the expectation that route control rooms will use these to manage railway safety, mean that railway route control staff require a significantly higher level of competence than in the past. The use of NRWS is just one example of this. Learning from other industries with roles comparable to that of route control is likely to be an effective means of assisting with this.
- 439 A paper by Dr M Jennings of Aberdeen University published in 2019 relates to the role of the offshore installation manager in the offshore oil industry,<sup>49</sup> a role which has many parallels to that of railway route control staff. In both cases, individuals are required to manage infrequent, but potentially high-consequence events within highly regulated and safety critical industries. The 2019 paper states:
- 'An effective competence assessment system for [offshore installation managers] in controlling emergencies is essential as sadly it has become all too apparent that an incident offshore can lead to significant loss of life and pollution of the environment'.*
- 440 Although the offshore operating environment is very different from a railway, the underlying skills required by control room staff have many similarities. The development of railway route control staff skills would therefore benefit from looking outside the transport industry, in addition to the more obvious sources of learning from transport organisations such as air traffic control and traffic management on highways.

---

<sup>49</sup> Jennings, M., 2019. 'The Oil and Gas Industry, the Offshore Installation Manager (OIM) and the management of emergencies - changes necessary to achieve effective competence assessment of OIMs in controlling emergencies'. The Journal of Loss Prevention in the Process Industries. Vol. 59, pp. 1-13.

### Network Rail audit and reviews of its recommendation management process

- 441 Recommendations made to Network Rail were subject to review by a 'recommendations review panel'. 'Local' recommendations were considered by review panels that were convened by the regions, routes or functions as appropriate. Recommendations made by RAIB or ORR, and those considered to be of national significance, were reviewed by the National Recommendations Review Panel (NRRP). The role of all review panels was to determine Network Rail's response to each recommendation and to allocate a lead manager to take forward the actions needed to implement it.
- 442 Since April 2020, Network Rail extended the remit of the NRRP to include the review and authorisation of 'closure statements' for RAIB recommendations. These statements described the actions taken in response to a recommendation and provided a justification for 'closure' of the recommendation. The purpose of this change was to ensure independent review and challenge of the actions taken and their effectiveness at addressing the recommendation and reducing risk.
- 443 The outcome of NRRP reviews and progress with the implementation of recommendations was discussed at regular meetings (approximately three-monthly) between Network Rail's recommendations management team and ORR. The same team also submitted a paper every six weeks to the SHE Committee on the status of recommendations. Progress with the implementation of certain important recommendations was reported directly to the executive committee (for example, those related to the Margam investigation; [RAIB report 11/2020](#)).
- 444 In July 2020, Network Rail commenced an audit of its business processes linked to the closure of recommendations made by RAIB and its own formal investigations. The purpose of the audit was to establish if there was a sufficient process in place to ensure that actions taken in response to investigation recommendations were effectively implemented. The audit report was issued in September 2020 and concluded that the process for tracking the recorded status of recommendations was working effectively, and noted the expansion of NRRP's remit to include the review of closure statements (as described at paragraph 442). However, it also identified three areas of particular concern:
- the lack of defined criteria to support the verification of recommendations closure
  - the absence of a process to audit the effectiveness and impact of controls modified in response to recommendations that are reported to be closed
  - weaknesses in the process for managing extensions to timescales for implementation.
- 445 Overall, the audit concluded that the process of verifying the closure of recommendations was 'unsatisfactory' and could lead to risks not being effectively mitigated. It identified a number of necessary improvements to the process for reviewing the actions taken in response to recommendations and any requests for extensions to timescales for completion, including greater engagement with functional directors and providing guidance on the criteria to be used when assessing whether or not to close a recommendation. It also identified the need for Network Rail to confirm the implementation of recommendations by auditing the effective implementation of critical and high-risk controls that had been modified in response to recommendations (see also paragraph 620).

- 446 A further audit, published in September 2021, identified that recommendations were sometimes closed on the basis that the risk would be addressed by future activities. The auditors identified the need to update process documentation to clarify that reliance on future activities is not a sufficient justification for closure of a recommendation. The same audit also tasked Network Rail's assurance team with conducting a risk-based review of previous recommendations which were closed on the basis of activities that had yet to be completed, with the objective of confirming that suitable risk controls are in place.
- 447 By November 2021, Network Rail had revised its business process documentation to incorporate learning from the September 2020 and September 2021 audit reports. Network Rail has now issued additional guidance on the criteria to be used by 'recommendation owners'<sup>50</sup> when considering the actions to take in response to a recommendation or whether enough has been done to address the recommendation. Furthermore, the NRRP is now actively engaged with the review and ratification of statements made in support of RAIB recommendation closure, and some closure statements have been rejected on the basis that the panel considered that the evidence in support of closure was insufficient.
- 448 At the time of publication of this investigation report, Network Rail was working to incorporate in its audit programme the consideration of risk controls that have been recently modified in response to recommendations. If successfully implemented, this measure will provide the executive leadership team with much better assurance that closed recommendations have been properly embedded, and provide improved visibility of any residual issues. The risk-based review of previous recommendations that were closed on the basis of future action is reported to be ongoing.

#### *Summary of issues associated with Network Rail's corporate learning*

- 449 RAIB observes that Network Rail had procured new technological tools to assist asset management and operational control. However, Network Rail appeared slow to take the decisive management actions to fully exploit the new technology, despite RAIB recommendations urging it to do so. By the time of the accident at Carmont, Network Rail had yet to introduce the training or written procedures that were needed to enable the routes' operational controllers to use the mass of information available to them. This meant that the value of important corporate learning was seriously undermined.
- 450 Similarly, despite numerous examples of sub-optimal management of operating incidents, Network Rail has yet to implement many of the practical changes needed to enable controllers to better manage operational incidents.
- 451 This investigation has revealed that Network Rail has processes in place that are designed to learn lessons from accidents and incidents. However, on occasions the organisation appeared corporately unaware of the effectiveness of changes following implementation of recommendations, and of how these changes were being implemented at a working level. RAIB concludes that Network Rail would benefit from a process that ensures that valuable corporate learning, from whatever source, is translated into practical measures for improvement.

---

<sup>50</sup> The lead manager with the responsibility for implementing the recommendation.

452 Learning from experience is dependent on an organisational culture that embraces the need for change in response to lessons learnt and is willing to question the effectiveness of the changes that it is making. This requires proactive safety leadership and the creation of a climate that encourages openness, honest reporting, and a willingness to challenge the way that changes are being implemented. Recommendation 6 of RAIB's investigation into the death of two track workers at Margam in July 2019 ([RAIB report 11/2020](#)) addresses the issue of safety leadership and culture in Network Rail, themes which have relevance to the creation of a culture that enables effective corporate learning.

## Examination of consequences

453 **RAIB has considered the following factors in relation to the consequences of the derailment:**

- **the circumstances: train speed, local topography and proximity to a bridge**
- **the unusually low number of passengers on the train because the accident occurred during the COVID-19 pandemic**
- **the structural damage to the vehicles**
- **causes of injury**
- **crashworthiness performance of the vehicles**
- **comparison with modern rolling stock**
- **guidance of derailed vehicles**
- **fire**
- **evacuation**
- **emergency egress.**

**Each of these factors occurred in the context of the derailment sequence in appendix E (figures E.1, E.2, onwards), and is discussed in the following paragraphs.**

### The circumstances of the derailment

454 The derailment occurred at a speed of 73 mph (117 km/h). Speed and train mass both affect the amount of kinetic energy that has to be absorbed before vehicles come to rest. Ideally, a derailed train should remain upright, and run close to its track, thereby avoiding impacts with other trains and infrastructure. This maximises the chances of the train's kinetic energy being absorbed gradually by the train's brakes (working on wheelsets that did not derail) and the ploughing of ballast by derailed wheelsets. Such energy absorption maximises the chances of a safe outcome for those on board.

455 However, in real-world accidents, there are often features of the track (for example, curves, points), surrounding topography (for example, embankments) and vehicle characteristics which cause derailed vehicles to deviate from the track. The vehicles may then scatter, collide with infrastructure or other vehicles, and roll over, all of which significantly increase the risk of injury to those on board.



- 456 The curvature of the track at the location of the derailment was a significant factor in the outcome. Once the train had derailed at the washout, the front of the leading power car deviated away from the track to the left. Most of the deviation (around 1650 mm) was caused by the train running straight ahead along the tangent line as the track curved to the right. A second factor which is likely to have aggravated the deviation was that the cess (paragraph 76) was an estimated 200 mm lower than the top of sleeper level, which would have tended to roll the leading bogie to the left. The third factor could have been greater ballast drag on the left wheels of the leading bogie (as the right-hand wheels were running over sleepers), tending to yaw the bogie anticlockwise (to the left). The increasing deviation of the leading bogie from the track, which resulted from a combination of these factors, helped the right-hand wheels to climb over the left-hand rail (paragraph 79) and put the power car on a collision course with the end of the bridge parapet.
- 457 The train collided with the end of the parapet, with the train's centre line slightly to the right of the parapet centre. The parapet was almost parallel to the track and the position of the impact meant that it could not guide the power car into the area between the parapet walls. The collision knocked a substantial amount of masonry from the end of the parapet (appendix E, figure E.4 and appendix F, figure F.5) before the bogie ran along the top of the parapet skimming off the *coping* (upper layer of) masonry. The force of the collision is likely to have caused the power car to yaw even further to the left and off the bridge.
- 458 The presence of the bridge meant that once the power car ran onto it, in its laterally displaced attitude, its left-hand wheels were no longer supported, causing the power car to veer off the bridge near its mid-span, and down to the embankment below. It came to rest on its left-hand side and at an angle with its leading end around seven metres below track level. The movement of the leading power car to the left is likely to have dragged the leading end of coach D to the left.
- 459 Beyond the bridge other topographical features aggravated the amount of jack-knifing and general vehicle scatter. Firstly, the wooded bank rising above the right-hand side (up-side) of the railway stopped coach C abruptly after it had run through some trees. This led to coach C pivoting about its leading end and rotating clockwise as its trailing end was pushed by the rest of the train. Subsequently, this brought it into collision with coach A and detached bogies, ending its travel by rolling onto its roof on top of coach D. The motion of coach C also pushed the leading end of coach B down the steep embankment to the left-hand side of the railway.

#### Low passenger numbers due to the COVID pandemic

- 460 The accident occurred during a period when the COVID-19 pandemic had resulted in a lockdown of the Aberdeen area in addition to a drop of around 65% in passenger numbers across the entire national network.<sup>51</sup>

---

<sup>51</sup> Department for Transport (DfT) data for 12 August 2020 from <https://www.gov.uk/government/statistics/transport-use-during-the-coronavirus-covid-19-pandemic>.

461 ScotRail provided an estimate to RAIB of the number of passengers it would have expected to be on the train during normal times, at between 25 and 50 passengers. In these circumstances the number of people on the train would have been between three and six times greater than on the day of the accident. The circumstances of the accident and the resulting movements of the vehicles were such that, with normal passenger numbers, the casualty toll would almost certainly have been significantly higher.

### Structural damage to the vehicles

462 As a result of the derailment, the leading power car and all four passenger coaches suffered substantial damage. The extent of the damage reduced progressively towards the rear of the train. The trailing power car did not suffer any significant damage.

463 When the leading power car struck the embankment below the bridge, the driver's cab, which was manufactured from glass fibre reinforced plastic (GRP), broke up and became completely detached (figure 72). The cab front, windscreen, roof and left-hand side remained attached together, and came to rest at the bottom of the embankment slope. The detached cab floor and driver's desk remained close to the leading end of the power car. At the trailing end of the power car, the roof and right-hand bodyside were severely damaged during the interaction with coach D on the bridge (figure 73). The underframe and equipment mounted on it were also severely damaged. The leading bogie became detached and was buried under the power car when it struck the embankment. The trailing bogie remained attached. Both bogies suffered extensive damage, particularly the leading bogie which had collided with the bridge parapet (figure 60).



Figure 72: Front of leading power car (cab became detached during accident)

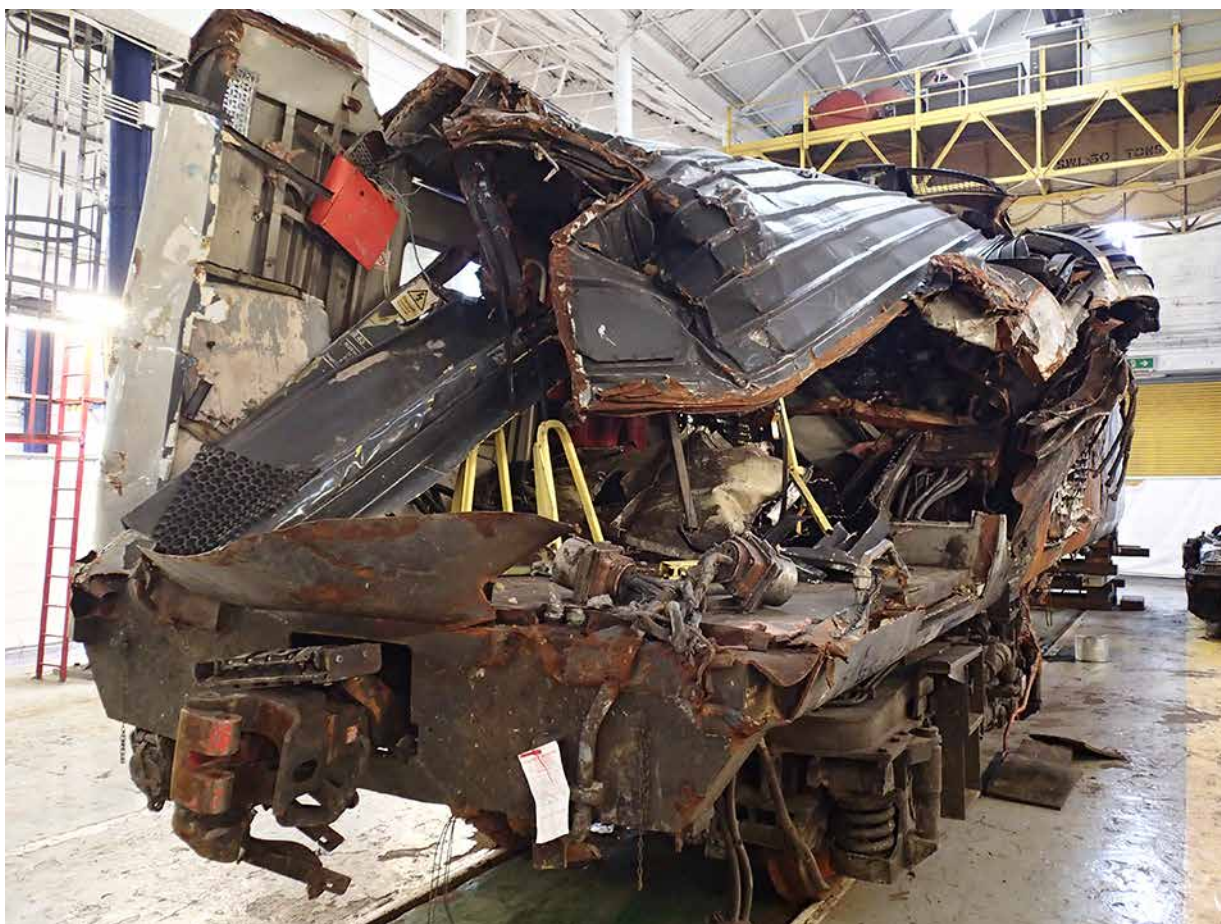

Figure 73: Damage to rear of leading power car

464 The first passenger coach (D) suffered the greatest damage of any passenger vehicle, mainly to the leading half. There was severe damage to the gangway pillars and corner pillars at the leading end of the vehicle which had sheared off at their attachment to the vehicle underframe, resulting in complete loss of survival space in the leading vestibule (figure 74). This damage occurred when coach D overrode the rear of the leading power car just after the power car had impacted the bridge parapet. Later in the sequence of events, when coach D rolled over onto its roof, the prior damage to its leading end meant that the integrity of the bodyside had been compromised and this led to a partial collapse of the leading half of the bodysides, and further significant loss of survival space in that area. The bodysides had creased along a line below the windows and several bodyside skin panels had split along weld lines. This splitting was also seen on other vehicles which had not been subject to such severe deformation and is discussed further at paragraph 501. Both bogies became detached, and there was extensive damage to underframe equipment.

465 The collapsed roof and bodysides on coach D also caused substantial disruption to the interior furniture, light fittings and trim panels in the leading half of the vehicle, but the seats and tables remained attached (figure 75). Almost all the windows in the leading half of the vehicle were broken through. Both bogies became detached and most of the underframe equipment was ripped off.

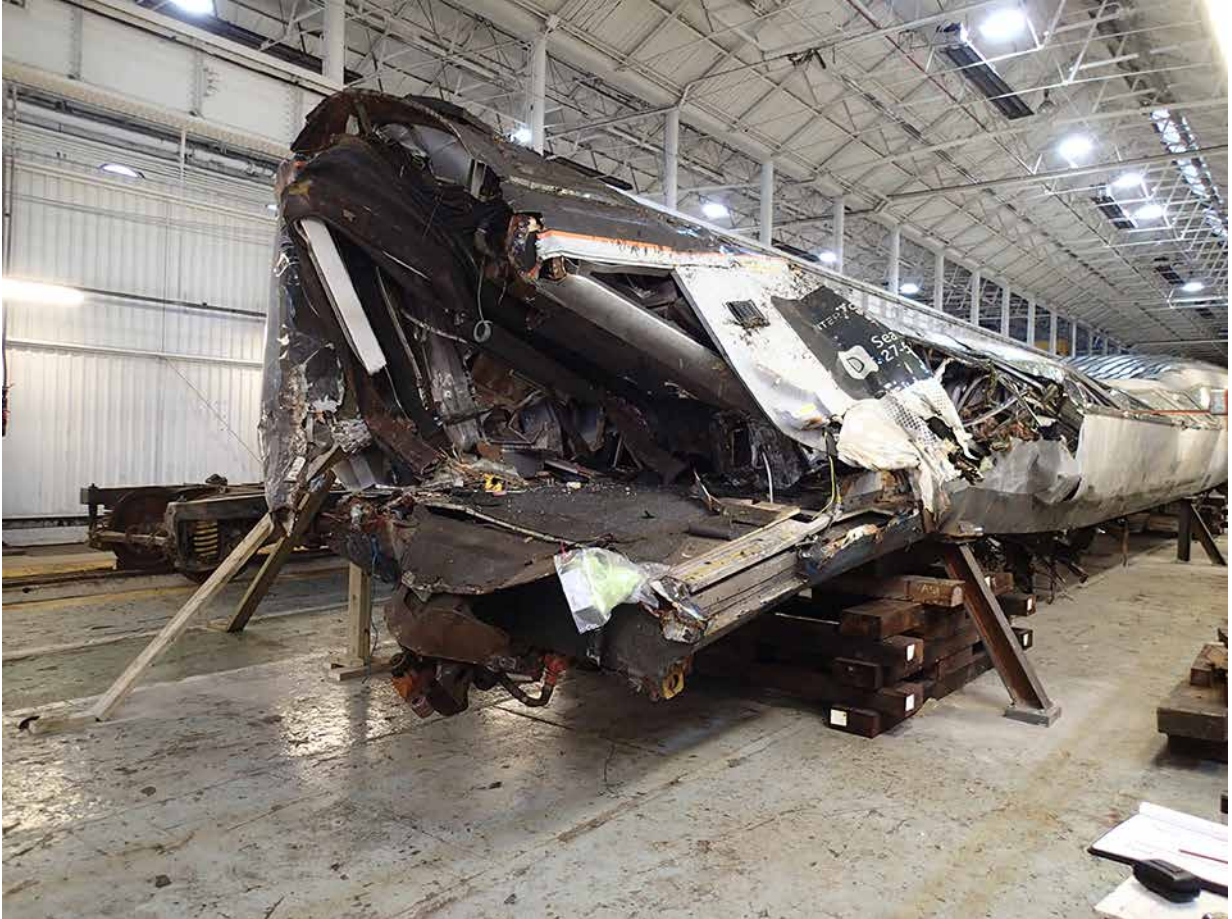

Figure 74: Damage to leading end of coach D



Figure 75: Interior damage at leading end of coach D

466 The second coach (C) sustained damage to the leading vestibule, which had struck trees and the rising bank on the right-hand side of the railway (figure 76). There was localised penetration damage to the trailing left-hand side (figure 77), most likely as a result of impacts with detached bogies. There was also penetration damage to the trailing right-hand side where coach A had struck coach C, leaving a part of coach A's cantrail (a longitudinal structural member running along the vehicle length above the windows) embedded in the side of coach C. Four windows along the left trailing side were broken through. The coach retained its survival space and the interior furniture remained in place, except within a localised area at the trailing end where the seats had been pushed into the aisle as a result of penetration damage to the left-hand body side. Both bogies became detached and there was severe damage to underframe equipment.



Figure 76: Leading end of coach C

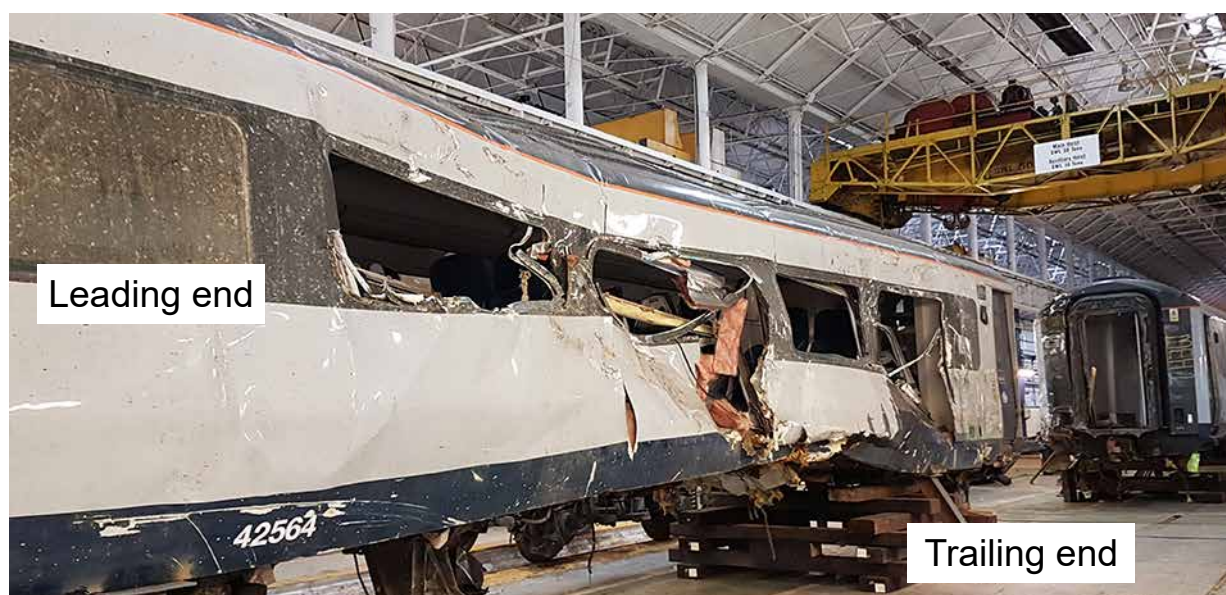

Figure 77: Penetration damage at trailing end of coach C (left side)

467 The third coach (B) sustained substantial damage to the right-hand body side, roof (which had been holed) and its underframe equipment (figure 78), and both bogies became detached. There was damage to the leading vestibule and detachment of an internal roof panel in the adjacent toilet, which had dropped but was held up by its secondary restraint. All the windows on the right-hand side and most of those on the left-hand side were broken through. There was no significant loss of survival space. Coach B later caught fire, which resulted in most of the vehicle's interior being burnt and the detachment of interior furniture in the trailing two-thirds of the vehicle (see paragraph 548).



Figure 78: Damage to leading end and right side of coach B

468 The fourth coach (A) suffered damage to the leading vestibule and localised damage to both bodysides (figure 79). There was no significant loss of survival space. The leading bogie and its pivot became detached and underframe equipment was severely damaged. Several windows were also shattered but not broken through. The interior remained intact.

469 The trailing power car did not suffer any significant damage.

### Causes of injury

470 The investigation analysed the physical injuries sustained by the passengers and staff on board the train to determine severity, likely causes and any safety lessons that could be learned. The analysis has not attempted to capture or assess the degree of psychological trauma suffered by the survivors.

471 Analysis of the injuries was undertaken for RAIB by two medical experts using the following information:

- post-mortem reports
- statements from medical professionals who treated survivors at hospital in Aberdeen
- witness statements

- photographic evidence
- inspection of the damaged vehicles
- reconstruction of the vehicle movements during the derailment.



Figure 79: Damage to leading end of coach A

472 Of the nine people on the train, three suffered fatal injuries: the train driver, the conductor and one passenger. A further three passengers suffered serious injuries. Three others, including the conductor travelling as a passenger, suffered minor injuries.<sup>52</sup>

473 For those who suffered fatal and serious injuries, all of whom had multiple injuries, a more detailed analysis was carried out to grade each injury. This was done using the internationally recognised abbreviated injury scale (AIS) scoring system. In this system each injury is scored from 1 for a minor injury to 6 for an injury that is thought to be 'incompatible with life'. Using these individual injury scores, an overall injury severity score (ISS) was evaluated for each person. The ISS score is obtained from the AIS scores for the three most severely injured body regions. The highest AIS in each of these body regions is squared and the three results added together to give the ISS. The higher a person's ISS score, the higher is the assessed overall severity of injury and their risk of mortality, which also depends on their age. For those who sustained fatal injuries the ISS score is set to 75 by the scoring system.

474 The distribution of injuries on the train, location of occupants, injury severity scores and likely primary cause(s) of injury are summarised in table 7.

<sup>52</sup> The Railways (Accident Investigation and Reporting) Regulations 2005 (RAIR regulations) provide a definition of what constitutes a serious injury for the purpose of injury assessment. Examples include fractures, dislocations, loss of consciousness and injuries requiring hospitalisation for more than 24 hours.

<b>Vehicle</b>	<b>Occupant and location</b>	<b>Injury severity (ISS score)</b>	<b>Likely primary cause(s)</b>
Leading power car	Driver Leading cab	Fatal Multiple injuries (75)	Secondary impact with the cab's windscreen and interior
Coach D	Conductor Leading vestibule	Fatal Multiple injuries (75)	Loss of survival space
	Passenger Leading end - RHS	Serious Multiple injuries (14)	Secondary impact with the vehicle interior, lacerations. Ejection from vehicle near end of its travel.
	Passenger Leading half - LHS	Serious Multiple injuries (17)	Secondary impact with vehicle interior, laceration. Ejection from vehicle near end of its travel.
Coach C	Passenger Leading vestibule	Fatal Multiple injuries (75)	Ejection from moving vehicle and consequent secondary impact with terrain
	Passenger Trailing half – RHS	Serious Multiple injuries (19)	Secondary impact with the vehicle interior
	Passenger Trailing half – RHS	Minor	Secondary impact with vehicle interior
	Passenger Trailing end – RHS	Minor	Secondary impact with vehicle interior
Coach B	None	N/A	N/A
Coach A	Conductor travelling as passenger Trailing half – RHS	Minor	Injury during egress
Trailing power car	None	N/A	N/A

Table 7: Distribution of injury severity on the train and principal causes.

475 The primary causes of the fatal injuries sustained by the people on the train were:

- secondary impact of the driver with the cab windscreen and interior, as the leading power car struck the embankment below the bridge (paragraph 463, figure E.7)
- loss of survival space in the leading vestibule of coach D where the conductor was standing, as the coach overrode the trailing end of the leading power car while on the bridge (paragraph 464, figures E.4, E.5)
- ejection of the passenger through the open gangway at the leading end of coach C, probably when it struck the wooded bank after it had traversed the bridge and run off to the right-hand side of the track (paragraph 466, figure E.8).

476 The primary cause of serious injury to three of the survivors was secondary impact with the vehicle interiors. Two passengers were seated in forward-facing seats and one was in a rearward facing seat. Coaches D and C both underwent extreme movements and rolled over onto their roofs (figures E.12 and E.13) before they came to rest. These movements would have subjected passengers to accelerations in the vertical, lateral and longitudinal directions, and would have caused them to impact the vehicle interior and/or fall out of their seats on the high side and onto the low side as the vehicles rolled over.



- 477 The two survivors in coach D also received multiple cuts and lacerations. Some of the windows in the leading half of this vehicle had been completely broken through and there was ingress of a significant amount of broken glass. Medical experts assisting the investigation considered that the shards of broken glass could have caused the lacerations, but it is also possible some were caused by exposed edges of damaged interior fixtures and fittings.
- 478 Both of the passengers at the leading end of coach D reported finding themselves outside the coach when the vehicle finally came to rest but could not recall how they got there. It is likely they were ejected from coach D as it was coming to rest near the end of its travel.
- 479 The minor injuries to three people comprised bruising to two passengers in coach C, most likely as a result of secondary impact with the vehicle interior, and a sprained ankle to the conductor travelling as a passenger in coach A, most likely caused during egress from the vehicle.
- 480 Despite the severity of the fires on site none of the occupants suffered injuries as a result of fire. At the time of the accident no one was in coach B and the fire broke out a considerable time after the accident (see paragraph 549).

#### Crashworthiness performance of vehicles

- 481 The HST was first introduced into main line service in the mid-1970s. The British Rail mark 3 coach was designed as a *monocoque structure* and manufactured from welded mild steel. The structure was designed to a set of static load cases to enable it to withstand the rigours of normal service operation and resist abnormal loading in accident scenarios. These requirements were similar to current standards for static strength but did not include the additional crashworthiness standards to which modern vehicles are designed to improve survivability in accidents, such as energy-absorbing vehicle ends (or crumple zones) and anti-override features.
- 482 During a long service life on main line railways, HSTs have been involved in some major accidents, the most recent being the derailment at Ufton Nervet (6 November 2004), and collisions at Ladbroke Grove (5 October 1999) and Southall (19 September 1997). Historically, they have generally performed well in terms of maintaining structural integrity and protecting occupants.
- 483 The behaviour of the train at Carmont was affected by characteristics of its design. Some of these positively affected the course of events and minimised the risk to occupants, while others adversely affected the outcome. These are discussed in the following paragraphs.

#### Driver's cab

- 484 The cab of the leading power car impacted the embankment below the bridge (appendix E, figure E.7). The resultant speed of impact is estimated to have been around 45 mph (72 km/h).
- 485 The structure of the driver's cab was manufactured from GRP and bolted directly to a bulkhead at the forward end of the engine compartment and the underframe of the power car. This is unlike most other modern train cabs which have a steel or aluminium cab superstructure covered by a relatively thin non-structural GRP fairing that provides an aerodynamic and aesthetic shape.

- 486 The GRP cab structure detached from its underframe mountings and the rear bulkhead, then broke up into several pieces on impact with the embankment. The cab roof, windscreen and left-hand side remained together and were found a distance of around 22 metres from the power car, towards the bottom of the slope, close to where the leading end of coach B came to rest (appendix E, figure E.10). The driver was found nearby. The cab floor, left and right-hand doors, driver's desk and seat detached to the left of the power car and came to rest at various positions, either close to the power car or further down the slope.
- 487 The cab was subjected to severe impact conditions. The speed of impact was significantly beyond the collision speeds for which even modern cabs are designed to provide protection for occupants. For example, the cab ends of more modern trains (since around 2000) were designed to absorb energy and protect the driver in collisions with an identical train at a closing speed of up to 60 km/h (37 mph).<sup>53</sup> Later train designs (since around 2010) were designed for a closing speed of up to 36 km/h<sup>54</sup> (22 mph), in line with European Technical Specifications for Interoperability. These design collision speeds are equivalent to a single train colliding with an immovable object (or plane of symmetry) at half the design speed. The estimated speed of impact between the power car and the ground at Carmont (paragraph 484) was over twice the higher of the equivalent design speeds into an immovable object. Given the severity of the collision conditions, significant damage to this or any other cab's structure was inevitable.
- 488 Driving cabs of HSTs and more modern trains designed before GM/RT2100 issue 4, December 2010, came into force are not fitted with seat belts or any other specific secondary impact protection (such as airbags and *knee bolsters*) for the driver. Train driving cabs designed after GM/RT2100 issue 4 came into force are required to undergo a dynamic crash test (typically a *sled test*) or validated simulation to prove specified injury criteria are not exceeded. However, these more modern cabs are not fitted with seat belts or airbags for secondary impact protection which previous research has identified as feasible. A significant amount of research work has been undertaken by the rail industry into providing better protections for train drivers. The earliest known work in the UK on improved driver protection measures was carried out as part of British Rail's crashworthiness development programme between 1992 and 1996, and culminated in a full scale dynamic crash test to validate the efficacy of various devices, such as airbags and knee bolsters, in minimising secondary impact injuries. Those tests confirmed that secondary impact protection for drivers was technically feasible. Subsequently, after the Ladbroke Grove rail accident in 1999, studies were carried out into possible options for retrospectively improving the safety of HST cabs in accidents.

---

<sup>53</sup> GM/RT2100 issue 3, 'Structural requirements for railway vehicles', October 2000.

<sup>54</sup> GM/RT2100 issue 4, 'Requirements for Rail Vehicle Structure', December 2010.

- 489 More recently (2003-2007) RSSB undertook a project 'Optimising driving cab design for driver protection in a collision' (T190<sup>55</sup>) to carry out further research into driver protection measures. It concluded that even relatively low speed collisions can result in the driver sustaining serious or fatal injuries, and that it was technically feasible to provide protection for drivers in frontal collisions with a similar train at closing speeds up to 80 km/h (50 mph). A viability assessment concluded that following the introduction of safety systems such as *Train Protection and Warning System* (which reduce the risk of collision), the costs of measures such as air bags, knee bolsters and seatbelts would have been grossly disproportionate to the benefits, and widespread installation within the industry would require wider industry consensus.
- 490 Although the research work to date had focused on train collisions, Carmont demonstrated that train drivers are vulnerable to fatal injuries arising from secondary impact with the cab interior in high energy derailments because these can sometimes lead to collisions with the infrastructure and/or lineside geographical features.

### Vehicle structures

- 491 The bodysHELLS of the mark 3 coaches generally performed well in the accident, resulting in only limited loss of survival space, even in coaches C and D which had rolled over onto their roofs, and resisted injurious penetration of passenger spaces during impacts with other vehicles and bogies.
- 492 However, there was complete loss of survival space in the leading vestibule of coach D, where the train conductor was located. This likely occurred when coach D overrode the trailing end of the power car, just before the power car veered off the bridge. The vestibule is protected by four body-end pillars, comprising two gangway pillars either side of the flexible gangway, and two corner pillars next to the doors. All the pillars at the leading end were sheared off at their bases.
- 493 The mark 3 coach design load cases included compressive forces applied to the body-end structure at specified heights above floor level, which set strength criteria for the pillars. Although the pillars provide a degree of protection, they are vulnerable when overriding occurs and collision forces exceed the strength of the pillars. This is a particular issue on the (lower) overridden vehicle, but pillars on the (higher) overriding vehicle are also vulnerable if loaded by the deformed structure on the overridden vehicle. Mark 3 coaches pre-date the current requirements for vehicle ends to be energy absorbing and so, when the pillars shear off, the body-end structure loses its ability to resist intrusion into survival spaces.
- 494 Mark 3 coaches do not have a door separating the vestibule at the end of the vehicle from the flexible gangway, which some modern trains have. There is no requirement in standards to have such doors and some modern trains have coach end openings extending to almost the full width of the carriages. Consequently, in the event of separation between two vehicles, occupants located in the vestibule or the ends of coaches are at significantly higher risk of ejection if there are no gangway doors.

---

<sup>55</sup> <https://www.rssb.co.uk/en/research-catalogue/CatalogueItem/T190>.

### Corrosion

495 Given the age of the vehicles, it was unsurprising that damaged areas of the mark 3 coach structures were found to have corrosion. RAIB considered whether the extent of corrosion may have significantly affected the way the coach structures deformed, and in particular the loss of survival space observed in coach D. Three areas were examined:

- corrosion in the body-end pillars of coach D
- ‘creasing’ along the bodysides of coach D
- splitting of the bodyside skin panels on coach D and other coaches.

496 Corrosion was observed at the base of the collision and corner pillars on the leading end of coach D (figure 80), where they joined the floor structure. In some areas 5 mm thick plates had been reduced to between 3.0 mm and 3.5 mm. There was also corrosion in the leading part of the underframe which supports these pillars.

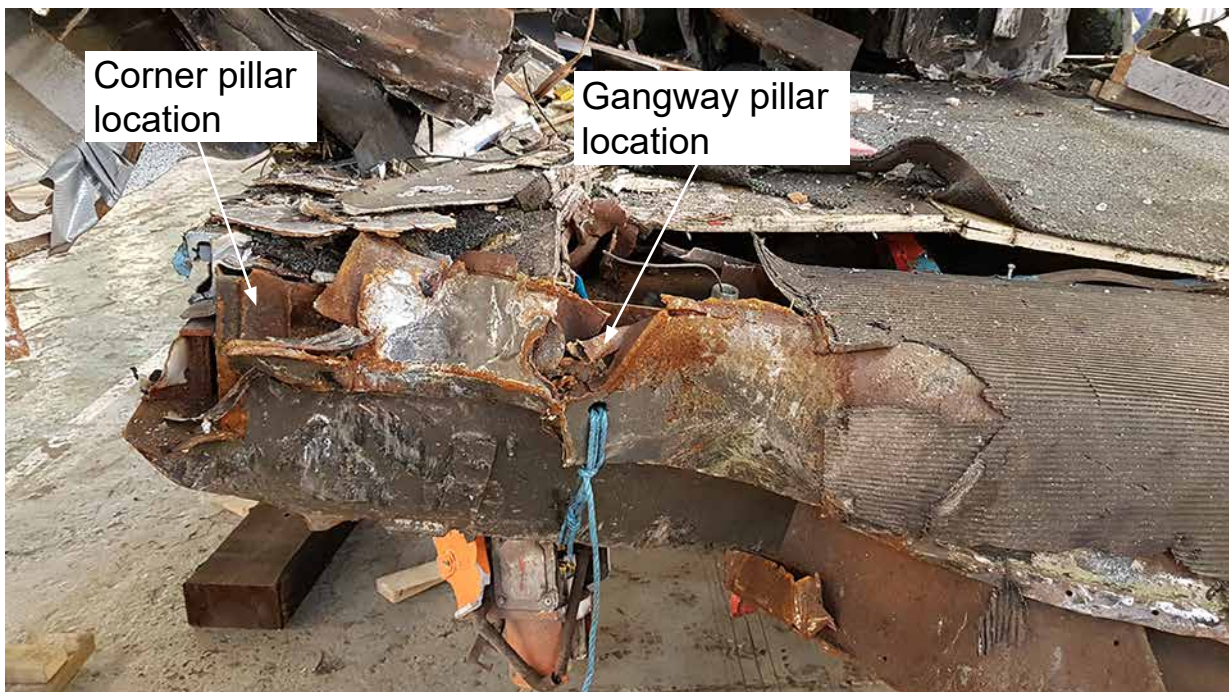

Figure 80: Corrosion on coach D at leading right-hand side of underframe at pillar locations

497 Corrosion repairs were undertaken on coach D by Wabtec from June to August 2019 as part of the power door modifications (paragraph 19). During the conversions that occurred before May 2020, which included the Carmont HST set, no formal corrosion allowances were specified for the body-end pillars. Engineering judgements about whether observed levels of corrosion required repair, were based on the expertise of staff. Wabtec reports that subsequently, in May 2020, guidance was introduced to assist staff deciding when repairs due to corrosion were needed. Records for corrosion repairs provided by Wabtec indicate that some localised corrosion had been identified on the two gangway pillars at the leading end of coach D, and repairs were authorised. There are no photographic records of the work actually done, and the pillars were too severely damaged in the accident for a meaningful retrospective assessment of this work.

- 498 Loss of material due to corrosion of the pillars would have weakened the body-end structure to some extent. The forces applied to the pillars in the interaction with the leading power car are not known, and therefore the investigation was not able to assess whether or not the original strength of the pillars (that is, without any material loss due to corrosion) would have been sufficient to resist the applied forces.
- 499 Finite element structural analysis calculations commissioned by Wabtec as part of the power door modifications showed that the additional structure added at the corner of the vehicle as part of the modifications improved the overall performance of the body-end under the proof design load cases. These analyses also indicated that there was some scope for uniform material loss due to corrosion (of around 20%) before the body-end structure would have started to yield locally under the original proof design load cases. RAIB calculations to assess the ultimate load condition (specified as 1.5 times the proof design loads) indicate that although there were pockets of corrosion with more than 20% material loss on coach D, provided the material loss in the area around the joints that fractured was localised, there should have been sufficient material left to be able to carry the ultimate loads specified in modern railway standards (GM/RT2100 issue 1, July 1994 and later issues). It is also possible that, even if there had not been any corrosion, the forces involved in the overriding could have been sufficiently high to shear the pillars.
- 500 A significant crease was observed along the left-hand side of coach D below the window line (figure 81). There was also a corresponding crease on the right-hand side above the windows. This creasing led to a loss of cross-sectional shape in the leading half of the bodyshell and significant loss of survival space in that area but did not result in splitting of the bodyshell along the crease line. Examinations of the exposed structure revealed no evidence of significant degradation of the structural members by corrosion. The creasing appeared to have been caused by mechanical overload, most likely when coach D rolled over onto its roof at the end of its travel and coach A came to rest on top of it. Having already lost its leading body-end structure, it is likely that coach D could no longer maintain its cross-sectional shape when the weight of the leading half of coach A came to rest on its leading end when upside down.
- 501 Vertical splitting of the bodyside skin panels was observed on all the coaches but particularly on coaches C and D. Examples of the bodyside splits on the left and right-hand sides of coach D are shown in figure 82. On examination, these were found to be due to failure of the welds that were laid to join the panels together during the original build, caused by inadequate depth of weld fusion. Because the mark 3 coach is designed as a monocoque structure the observed splitting of the skin panels is also likely to have aggravated the deformation of coach D.



Figure 81: Creasing along left-hand bodyside of coach D



Figure 82: Bodyside skin splitting on coach D, left side (a) and right side (b)

### Couplers

502 HSTs are fitted with 'Alliance' couplers, which were not able to withstand the forces and relative vehicle movements during the derailment. All the vehicles became uncoupled except at the interface of coach A and the trailing power car. The uncoupling allowed the vehicles to scatter and roll over, and increased the risk of secondary impact with the infrastructure and other vehicles and their bogies.

503 The typical failure mode of the coupler was fracture of either the upper or lower half of the knuckles of the coupler (figure 83). The same failure mode of the Alliance coupler was also noted in the investigation following the derailment at Ufton Nervet.<sup>56</sup>

<sup>56</sup> J H Lewis, P Matthews, S Cokayne, 'Structural assessment of the rolling stock involved in the derailment at Ufton level Crossing on 6<sup>th</sup> November 2004', AEA Technology Rail, February 2005.

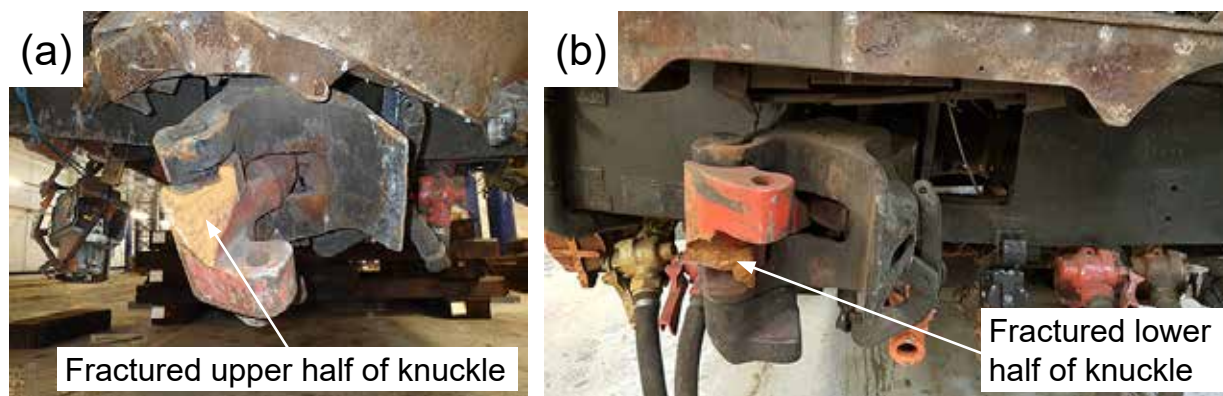

Figure 83: Fractured knuckles on the couplers of coach D leading end (a) and trailing end (b)

### Bogie retention

504 The leading bogie of the leading power car was found under this vehicle on the embankment, with the heavy-duty wire rope retention straps broken. This indicated that the bogie had been retained until the leading power car impacted the embankment below the bridge. None of the other power car bogies became detached.

505 Mark 3 coaches (unlike vehicles designed after July 1994) are not fitted with any form of bogie retention in the vertical direction, and this allowed the vehicle bodies to lift off their bogies during the derailment. With the exception of the trailing bogie of coach A, all the other coach bogies detached. In nearly all cases there was minimal damage to the body-mounted centre pivots, indicating that separation had occurred by the vehicle bodies lifting off the bogies, most likely as a result of severe *pitching* movements.

506 The loss of so many bogies would have adversely affected the ability of the train to dissipate kinetic energy in a benign way by braking, and by bogies running derailed through ballast. As a consequence of losing their bogies, coaches B, C and D were also free to slide and roll in an uncontrolled manner; attached bogies tend to resist sliding because they dig into the ballast. The detached bogies also became obstacles in the path of the vehicle bodies and coach C is likely to have suffered some of its penetration damage (paragraph 466) as a result of striking detached bogies. Detachment of mark 3 coach bogies was also noted in previous accidents at Ladbroke Grove and Ufton Nervet. A study undertaken by RSSB to improve the understanding of accident survivability in relation to the structural crashworthiness and dynamic stability of rail vehicles in the event of an end-on collision concluded that under 'off-track' conditions there are more benefits to be gained in retaining bogies than allowing them to detach.<sup>57</sup>

<sup>57</sup> T118 Whole Train Dynamic Behaviour in Collisions and Improving Crashworthiness Final Report, issue 1 15/12/2008.

### Vehicle interiors

- 507 The vehicle interiors performed well in the derailment; despite the severe movements and roll-over that the vehicles were subjected to, none of the seats and tables in coaches A, C, and D became completely detached. Detached furniture and fittings pose a significant risk to occupants in high energy accidents. At the leading end of coach D, which had been subject to severe structural damage, furniture had become severely distorted but remained attached. All the seats and tables in the burnt-out parts of coach B were completely detached, while those in unburnt parts remained attached.
- 508 Interior trim panels and light fittings generally remained attached except in the leading half of coach D, but even in this area, detached fittings did not encroach significantly into the passenger spaces. A ceiling access panel in the toilet at the leading end of coach B fell down partially but was still held up by one of its two secondary restraint lanyards.
- 509 Penetration damage to the left-hand side of coach C at the trailing end caused the seats in that area to be pushed in (without detachment), fully encroaching on the aisle space. However, because this vehicle rolled over onto its roof, the aisle blockage did not stop the three surviving passengers self-evacuating from the trailing end, which came to rest above coach D.

### Folding tables

- 510 The folding tables used with the single 'priority' seats at four locations in the first class coach A were observed to have a particularly sharp corner when in the folded position (figure 84b). This corner could cause injury to a seated forward-facing passenger in the event of a train collision in which they were thrown forwards into the table. The same folding table design is also used in coach B at two locations adjacent to wheelchair positions. In the coach B positions, it poses less of a risk to a passenger sitting in a wheelchair because the side of the wheelchair frame would impact the sharp corner. When in the flat (down) position, no sharp edge is presented (figure 84a). No occupants were seated next to these folding tables or injured by them during the derailment at Carmont.

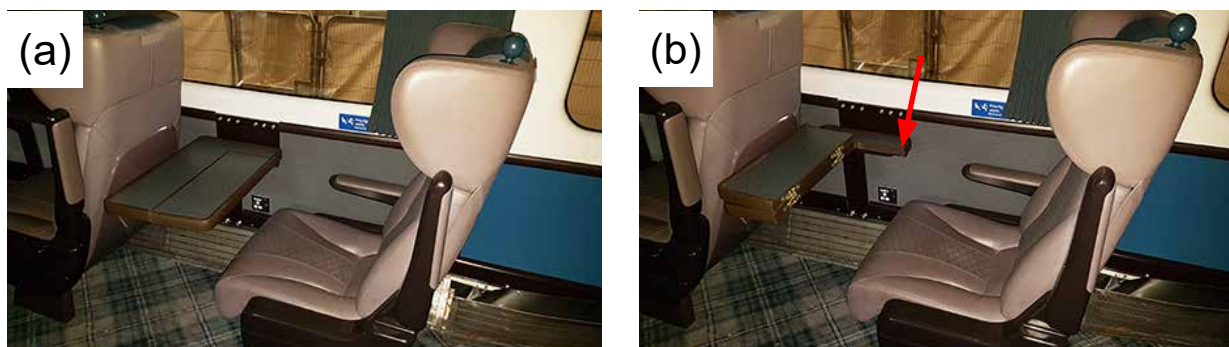

Figure 84: First class folding table from coach A in flat position (a) and folded position (b). Sharp corner indicated by red arrow. The same table design is also used at two positions in coach B



- 511 This design of folding table was first introduced into railway service by Great North Eastern Railway (GNER) as part of its mark 4 'Mallard' refurbishment project in 2002/3. Dynamic testing of the seat and table was carried out at the time to check compliance with railway code of practice AV/ST9001, 'Vehicle Interior Crashworthiness', issue 1, February 2002, which was not a mandatory standard at that time. A requirement of the standard (clause 5.1) was that all areas which could be subject to a foreseeable secondary impact shall be free of sharp areas, inserts, edges and projections. However, there is no evidence from the available records that the sharp corner was ever identified as a potential risk, and the table design was certificated for railway use.
- 512 Subsequently, the same table design was introduced into GNER's mark 3 coaches in 2006 as part of another refurbishment project. Although further dynamic tests and design scrutiny were carried out to check compliance of the folding table and seat in the mark 3 arrangement, the sharp corner was not identified as a potential risk. When the table design was introduced by Wabtec into the ScotRail mark 3 coach refurbishment programme (December 2017 to April 2020), the scope of work did not include a crashworthiness review of the folding tables, and they were accepted on the basis of being unchanged from those previously fitted to the GNER mark 3 and mark 4 coaches.
- 513 By the time of the ScotRail refurbishment, Railway Group Standard GM/RT2100 issue 5, June 2012 was in force. It required (clause 6.1.6) that a secondary impact assessment be made of tables and other furniture to demonstrate that the risk of injury is controlled, and included specific mention of sharp corners as a potential hazard.

### Seat belts

- 514 Mark 3 coaches, in common with all other passenger rail vehicles in the UK and other countries, are not fitted with seat belts. This means that in high energy accidents, train occupants are vulnerable to secondary impact injuries as a result of being thrown around the vehicle interior. Three of the six survivors sustained serious injuries, assessed as being caused by secondary impact. The other three sustained minor injury as a result of secondary impact. Seat belts could have been effective in reducing the severity of the secondary impact injuries if they had been fitted and worn by the occupants at the time of the accident.

515 Following the derailment at Ufton Nervet, the railway-led formal inquiry into the accident<sup>58</sup> recommended that research be undertaken to assess whether there could be a net safety benefit in fitting seats belts on passenger vehicles. RSSB subsequently undertook research on seat belts and concluded<sup>59</sup> that:

*‘Seat belts have the potential to restrain people during accidents, but they can also cause damage to the wearer through their impact on different parts of the body under similar circumstances. More importantly, the analysis of injuries and damage to vehicles showed that, if people were restrained in their seats during an accident, the loss of ‘survival space’ arising from damage and intrusion to the bodysides of passenger vehicles would be likely to lead to more injuries and fatalities than if people are not so restrained. The seat reinforcement required for fitment would also increase injury potential for occupants who, for whatever reason, were un-belted (that is, they would have something harder to strike against). Accordingly, the use of seat belts in passenger trains was ruled out and the passenger and crew containment strategy was established’.*

516 Following the derailment at Grayrigg ([RAIB report 20/2008](#)), RAIB made a recommendation (recommendation 25e) to RSSB to review its previous research on seat belts, because passengers had been thrown around the vehicle interior in that accident but there had not been any significant loss of survival space. Therefore, the additional risk of passengers suffering crush injuries because they had been restrained in their seats (noted in the RSSB research as a significant disbenefit of seat belts) did not materialise. ORR subsequently reported to RAIB that the recommendation had been duly considered by RSSB, but no further research work was done. RAIB observes that survival space was lost in some seating areas at Carmont, but not to the extent that it affected passengers who were seated when the accident occurred.

517 RAIB believes that RSSB’s original (post Ufton Nervet) justification for the non-fitment of seat belts for passengers (paragraph 515) is not supported by the more recent crashworthiness investigations carried out following the derailments at Grayrigg and Carmont. However, RAIB acknowledges the many practical difficulties associated with seat belt fitment (such as standing passengers) and the likelihood that any cost benefit evaluation is most unlikely to show that it is reasonably practicable to fit them.

### Window breakage

518 Breakage of bodyside windows usually occurs in high energy accidents when vehicles roll over, are severely damaged or are struck by debris. Mark 3 coach windows comprise a glazing unit installed within a mounting frame. The main risk from such window breakage is that a hole could form in the side of the vehicle through which passengers may be ejected while the train is moving, usually resulting in fatal injuries. Another risk is that broken glass can cause serious cuts and lacerations to passengers inside the vehicle.

---

<sup>58</sup> Formal Inquiry final report: ‘Ufton level crossing passenger train collision with a road vehicle and subsequent derailment on 6 November 2004’, RSSB, 21 June 2005.

<sup>59</sup> ‘Report on improvements in the safety of passengers and staff involved in train accidents’, RSSB, 2009.

- 519 The bodyside windows on the mark 3 coaches of train 1T08 were installed during a refurbishment in 2006/2007. They were designed to comply with standard GM/RT2456.<sup>60</sup> Additionally, the windows were designed to meet a set of requirements that were issued in 2006 relating to passenger containment, following lessons learned from the derailment at Ufton Nervet.<sup>61</sup> Those additional requirements were subsequently absorbed into the current standard for bodyside windows (GM/RT2100).
- 520 To address the risk of passenger ejection, rail vehicles in the UK are fitted with double glazed bodyside windows which contain a laminated pane on the inside of the vehicle. The glazing units on the mark 3 coaches in train 1T08 comprised a 5 mm thick outer pane of toughened glass, a 6 mm spacer gap and a 7.5 mm laminated inner pane. The laminated pane is designed to provide containment of passengers within the vehicle as far as possible in the event of roll-over and passengers falling onto it. In such circumstances, it is expected that the glass will break but still hold together sufficiently to provide containment.
- 521 Of the 61 main bodyside windows on the passenger coaches, 22 windows were found during post-accident inspection to be completely broken through (no glass left to provide passenger containment). There were five such broken windows on coach D (and a further two that were partially broken through), four on coach C, thirteen on coach B and none on coach A. Generally, those on coaches C and D and the right-hand side of coach B were in areas that had suffered significant bodyside damage and consequent distortion of the window mounting frames. Those on the left-hand side of coach B (uppermost when it came to rest) were likely to have been broken as a result of the subsequent fire in that vehicle, except for the leading left-hand window which had suffered damage to the mounting frame.
- 522 Some other windows on the vehicles had shattered inner and/or outer panes, but the glazing remained in place. In some of those cases windows were partially holed, although insufficiently for a person to be ejected through them. Some windows were also partially holed during recovery operations.
- 523 Two survivors in coach D reported finding themselves outside the coach when the vehicle came to rest. They did not know how they got there; it is likely that they were ejected through broken windows as the coach rolled over near the end of its travel. No passengers were ejected through windows while the vehicles were moving during the derailment sequence.
- 524 Examination of the interior of coach D showed there had been significant ingress of glass 'dice' from the broken windows, and many large shards of glass that had become detached from the inner laminated pane (figure 85). Both passengers who survived the accident in coach D suffered laceration injuries which may have been caused by these pieces of broken glass.

---

<sup>60</sup> Railway Group Standard GM/RT2456 issue 2, April 2002 'Structural requirements for windscreen and windows on railway vehicles.'

<sup>61</sup> Specification for Replacement Double Glazed Window Units Incorporating Laminated Glass for Use in Mk III Vehicles, AEATR-ES-2006-014 issue 1.

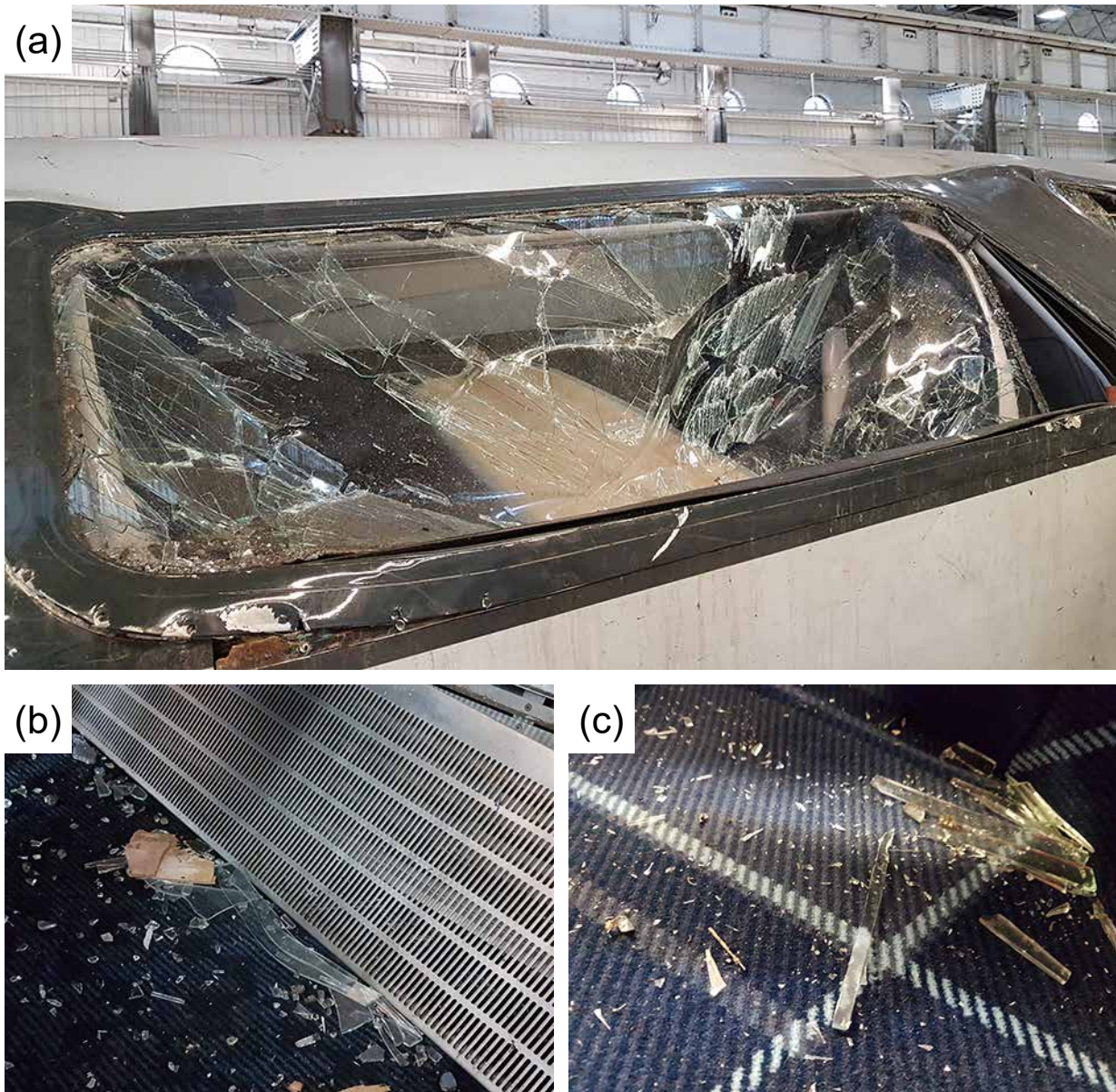

Figure 85: A broken window on coach D with remnants of inner laminated pane (a), ingress of large shards on the floor (b) and on a seat (c)

525 RAIB consulted Independent Glass, the manufacturer of the glazing unit, about the manner in which some of the inner laminated panes in coach D had shattered into large pieces (rather than small dice-sized pieces) and then detached from the interlayer.

- 526 The laminated pane is made up of a 1.52 mm thick polyvinyl butyral (PVB) interlayer bonded on both sides to 3 mm thick panes of clear heat-strengthened glass, using heat and pressure. The manufacturer explained that the additional passenger containment requirement, which was introduced after the Ufton Nerve derailment (to minimise the risk of passenger ejection), required the use of heat-strengthened glass for the laminated pane rather than toughened glass,<sup>62</sup> which would not have provided the required containment performance. The glazing unit was also constrained in thickness to fit within existing frames. The detachment of glass from the interlayer was caused by distortion of the glazing unit as a whole after the laminated pane had been broken, as a result of subsequent deformation of the vehicle structure.
- 527 The performance of the bodyside glass in the circumstances of the Carmont accident (breakage of the glass followed by subsequent distortion of the glazing unit) is not covered in standards. Post-accident, the manufacturer stated that the observed behaviour was as expected for these circumstances. The manufacturer has advised RAIB that there may be scope for improving the performance of bodyside glazing units further to reduce the risk from large shards entering the vehicle interior in accidents, without compromising the passenger containment performance. The manufacturer has stated that such improvements would require further research and the use of alternative materials for both the glass and interlayer.

### Comparison with modern rolling stock

- 528 The investigation considered what might have happened if the accident had involved a train compliant with modern structural and crashworthiness standards (that is, designed and manufactured since the first issue of standard GM/RT2100), to assess if the overall outcome is likely to have been better or worse in terms of casualties. While it is never possible to be certain about what would have happened in the hypothetical situation with different rolling stock in the same accident, the following paragraphs discuss the additional passive safety features modern trains are built with, and whether these could have helped at Carmont.
- 529 Lifeguards, located in front of the leading wheels, are intended to be the first line of defence against relatively small obstacles on the track which could lift a wheel into derailment. Previous accidents involving trains running into landslips (for example, Moy, [RAIB report 22/2006](#) and Watford, [RAIB report 11/2017](#)) have demonstrated that although the trains involved derailed, modern lifeguards are generally capable of withstanding impacts with landslip debris on the track without complete loss of structural integrity. As explained at paragraph 271, a modern lifeguard has over twice the ultimate strength of an HST lifeguard. The evidence from the lifeguards at Carmont (paragraph 273) is that they lost their structural integrity while running through the debris and were unable to perform a clearing function. Although a stronger modern lifeguard might have been better able to move sufficient washout debris out of the path of the leading wheelset to prevent the derailment, RAIB had insufficient evidence to determine the likelihood of this improved outcome.

---

<sup>62</sup> Both types of glass are heat treated but heat-strengthened glass undergoes a slower cooling process than toughened glass and shatters into larger pieces than toughened glass when broken.

- 530 Modern trains designed to Railway Group Standard GM/RT2100 issue 1, July 1994 (and later) with leading axle loads less than 17 tonnes, are also fitted with obstacle deflectors at each end of the train. The minimum axle load of an HST power car is 17.6 tonnes.<sup>63</sup> More recent trains, compliant with European Technical Standards for Interoperability, have obstacle deflectors regardless of axle load. The purpose of these devices is to minimise the risk of derailment in the event the train strikes a large obstacle (for example, an animal or car) on the track. They are mounted off the vehicle body ahead of the bogie mounted lifeguards and span the full width of the track. It is unlikely that an obstacle deflector would have been effective at Carmont because the depth of the washout material covering the track was too low to have engaged with the bottom edge of the deflector.
- 531 Modern trains are fitted with anti-climb features (either as serrated pads fitted to the vehicle ends or built into the couplers) and energy absorbing vehicle ends to prevent override and uncontrolled structural collapse in collisions. Had the train been fitted with these features, overriding between the leading power car and coach D is less likely to have occurred, and in such a case survival space in the leading vestibule of coach D might have been better preserved.
- 532 Generally, modern vehicles feature robust couplers which are better able to resist the large movements and bending forces which couplers are subjected to in derailments, without failure or uncoupling. Although there are limits to the ability of couplers to keep vehicles together, evidence on coupler performance from the accident at Grayrigg in 2007 ([RAIB report 20/2008](#)) indicates that stronger couplers are likely to have led to less vehicle scatter at Carmont.
- 533 RAIB has considered whether, in the circumstances at Carmont, stronger couplers might have resulted in coach D, and possibly other coaches, being pulled off the bridge by the leading power car. While this possibility cannot be discounted, it is considered unlikely. This is because stronger couplers, working together with anti-climb devices (if not fitted within the coupling system itself) and energy-absorbing vehicle ends should have prevented the overriding that occurred at the interface between the power car and coach D. In the absence of overriding at this interface, the rear of the leading power car would be likely to have remained coupled to coach D. This would have increased the likelihood of coach D continuing to run on its leading bogie and thereby provide greater stability to the rear end of the leading power car. This might have been sufficient to keep the leading power car on the track for longer, increasing the likelihood of it completely traversing the bridge still coupled to coach D. However, further jack-knifing between the leading power car and coach D beyond the north end of the bridge might still have occurred.
- 534 Bogie retention is designed into modern vehicles by means of design load cases for body to bogie connections, which have been mandated in relevant standards since around 1988, so that bogies remain attached to the vehicle bodies as far as practicable in derailments and collisions. Retaining bogies increases the chances of keeping vehicles upright and in line and minimises the risk of jack-knifing and vehicle scatter. Additionally, as the bogies run derailed, they dissipate the train's kinetic energy in a benign way by ploughing through ballast. Therefore, bogie retention is likely to have led to a better outcome.

---

<sup>63</sup> The axle load will vary depending on the fuel and other consumables carried by the vehicle; a power car weighs a nominal 70.25 tonnes empty of consumables.

535 For these reasons, RAIB considers it more likely than not that the outcome would have been better if the train had been compliant with modern crashworthiness standards. Although any such comparison is necessarily subjective, a comparison with the derailment at Grayrigg in February 2007 provides some evidence to support this.<sup>64</sup> The nine-car Pendolino train that derailed at Grayrigg ([RAIB report 20/2008](#)), which was designed to modern crashworthiness standards, was carrying 109 people and travelling at a speed of 95 mph (153 km/h). The ratio of kinetic energy to train weight involved in that derailment was around 1.7 times that at Carmont, and it occurred close to a steep embankment which also adversely affected the train's post-derailment behaviour, causing some limited jack-knifing and vehicle separation. One passenger was fatally injured, 30 people (including the train driver and one other crew member) received serious injuries and 58 passengers received minor injuries.

### Guidance of derailed vehicles

536 The curvature of the track to the right after the washout, combined with the cress being lower than sleeper level, meant that the deviation of the leading bogie when it reached the bridge (about 2.2 metres to the left) was sufficient for it to collide with the bridge parapet. Neither the track nor the bogie was fitted with equipment which would restrict deviation from the track after a derailment.

537 At the time of the derailment, no guard rails were installed on the approach to and over the bridge at Carmont. The purpose of guard rails is to contain any derailed wheels so that they remain close to the track and do not allow the train to deviate into collision with the infrastructure (for example, tunnel portals, bridge parapets) or trains on adjacent lines. Guard rails usually comprise a pair of parallel steel rails fitted to the sleepers in the four-foot. The ends of the rails are usually tapered so that they converge to a point at the centre of the track and are able to gather any derailed wheels. Gathering rails can also be fitted outside the running rails. To be effective in guiding a derailed train approaching a high-risk area, guard rails need to extend for a sufficient distance on the approach to the tunnel, bridge or other feature that poses the potential risk to the derailed train. Guard rails have since been installed at the Carmont accident site as part of the track reinstatement works (figure 86).

538 A guard rail or *containment kerb* could have prevented excessive deviation (paragraph 456) of the leading bogie and thereby avoided the collision between the leading power car and the bridge parapet, which is likely to have led to a significantly better outcome. However, to have been effective in containing the lateral deviation of the leading bogie at Carmont, a pair of guard rails would have needed to extend out from the bridge (towards the approaching train) for a minimum distance of around 35 metres. Observations of the wheel paths indicated that at this point the right-hand wheels of the leading bogie had reached the centre of the four-foot. Guard rails significantly shorter than this would not have been able to gather and guide the derailed right-hand wheels of the leading bogie.

---

<sup>64</sup> <https://www.gov.uk/raib-reports/derailment-at-grayrigg>.



Figure 86: Guard rails fitted post-accident at bridge 325. The gathering rails are positioned at the start of the guard rails to the right of the main picture

539 Network Rail standard NR/L2/TRK/2102, 'Design and construction of track' issue 8, September 2016 (compliance date 1 March 2017) was in force at the time of the derailment. Clause 6.5.3 relates to deciding whether guard rails are required and the length of track on which any guard rail should be used. In relation to guard rails, it states:

*'When track is to be renewed adjacent to parapets and the edges of embankments with a vertical face or where the consequence of a derailment is high the RAM [Track] shall consult the RAM [Civils] on what is to be provided.*

*The following factors should be taken into account in the review:*

- a) Line speed;
- b) Curvature;
- c) Height of structure;
- d) Dead load on the structure;
- e) Clearances to structural members;
- f) Ballast depth;
- g) Consequential risk;
- h) Type and frequency of traffic;



i) *Existence of derailment-containment kerbs;*

j) *Condition of the structure and parapet.*

*At the approach end, the parallel portion of guard rails shall extend 18 m beyond the face of the abutment (or the location at risk) and include a set of gathering rails.*

*Where guard rails already exist and they are removed, the justification for their removal shall be recorded by the RAM [Track] in consultation with the RAM [Civils].'*

- 540 There is no evidence suggesting that guard rails have previously been fitted on the approach to the bridge at Carmont. None are shown in a photograph taken shortly before the last track renewal between 1966 and 1970, before standard NR/L2/TRK/2102 was applicable. Ministry of Transport requirements from 1957 state: *On all important bridges and viaducts, where necessary, special arrangements to be made to keep derailed wheels close to the track alignment.*<sup>65</sup> The guidance does not specify what constitutes an important bridge.
- 541 If guard rails had been installed at bridge 325, extending 18 metres beyond the ends of the bridge, as specified in NR/L2/TRK/2102, this is unlikely to have significantly affected the outcome of the accident. An 18 metre long guard rail would not have gathered the right-hand wheels of the leading bogie, which had passed across the centre of the four-foot much earlier, at around 35 metres from the bridge (paragraph 538).
- 542 At locations where there are no guard rails or containment kerbs, excessive lateral deviation from the track could also be prevented by bogie mounted equipment designed for that purpose. HST power car bogies do not have any such equipment and it is not a requirement of railway standards. However, some trains have bogie mounted features which, though designed for other purposes, have had the ability to restrain lateral deviation in the event of derailment so that bogies have remained close to the track while running derailed. Examples of this are the passenger trains involved in the derailments at Watford (September 2016), Barrow upon Soar (February 2008) and Moy (November 2005). The good performance of the trains in these previous accidents in terms of staying close to the track shows that had the train at Carmont had the same capability, it would have been more likely to have remained close to the track and so avoided the particularly destructive sequence of events triggered by striking the bridge.
- 543 Following the derailment at Watford, the industry has undertaken research into infrastructure and vehicle-based derailment mitigation devices in response to RAIB's Watford Recommendation 3 (RSSB project T1143, appendix K). The accident at Carmont reinforces the importance of this work, and therefore RAIB has made two further recommendations on derailment mitigation in this report to build on this recent work, taking into account the learning from Carmont.

<sup>65</sup> Ministry of Transport and Civil Aviation: 'Requirements for passenger lines and recommendations for goods lines' HMSO 1950, reprinted 1957.

## Fires

### Fire in leading power car

544 Immediately after the leading power car came to rest it was seen to be on fire.

To assist with understanding the origin, growth and spread of this fire, and a subsequent fire in coach B, RAIB commissioned investigation work from The Fire Research Centre, part of the University of Edinburgh School of Engineering, and its findings are incorporated in this report.

545 The diesel engine fitted to a class 43 power car is located in an engine room in the centre section of the vehicle. Between the engine room and the cab is a further compartment, known as the clean air compartment, which contains electrical equipment. Bulkheads separate the engine room from the clean air compartment, and the clean air compartment from the cab. The engine is supplied with fuel from aluminium alloy tanks fitted on the underframe of the vehicle. The fuel capacity of each power car is around 1029 gallons (4678 litres). Both power cars of train 1T08 had been refuelled the night before the accident, so were almost full at the time of the derailment.

546 Post-accident examination of the fuel tank of the leading power car showed it had been ruptured during the accident, and the absence of other readily combustible material indicates that fuel from this tank sustained the fire. Although the investigation did not establish the precise mechanism by which the fire started, it is possible that damage to the fuel system sustained during the accident may have given rise to diesel fuel being spilled or sprayed; this fuel could have ignited on hot surfaces, or as a consequence of arcing or sparks from damage to electrical systems.

547 The fire caused severe damage to the engine compartment of the power car. The fire penetrated the clean air compartment of the power car, located directly behind the cab, but did not penetrate the bulkhead separating the clean air compartment from the cab. The fire stayed confined to the leading power car and the vegetation in the area immediately around it (figure 87).



Figure 87: Fire-damaged leading power car

### Fire in coach B

548 Passenger rail vehicles are constructed to standards intended to protect people from the effects of fires. These standards cover areas such as the fire performance of materials used in coach interiors, and the provision of fire barriers along with fire detection, warning and extinguishing systems. RAIB has considered fire-related guidance and requirements current at the time of the accident or earlier, as listed in table 8. Although these were all introduced after initial construction of the mark 3 coaches involved in the Carmont accident, the coaches, including modifications after initial construction, were compliant with the requirements.

<b>Document</b>	<b>Dates applicable</b>
CP/DDE/101 - Code of Practice to improve the safety of passengers and crew in the event of a fire in railway traction and rolling stock vehicles.	1983 to 1990
BS 6853 - Code of Practice for fire precautions in the design and construction of passenger carrying trains.	1987 to 2013
GM/TT 0116 - Fire protection systems on Traction and Rolling stock (superseded by GM/RT2120).	May 1993 to December 1998
GO/OTS 220 - Emergency egress from passenger rolling stock.	May 1993 to December 1999
GM/TT 0080 - Retaining and upgrading the fire performance of rolling stock (superseded by GM/RT 2125).	March 1993 to December 1999
GM/RT 2125 - Fire performance requirements for railway vehicles (superseded by GM/RT 2120).	February 1996 to December 1998
GM/RT 2120 (Issues 1 and 2) - Requirements for the control of risks arising from fires on railway vehicles (superseded by GM/RT 2130).	August 1998 to August 2008
AVST 9002 (Issue 1) - Vehicle interiors - design for evacuation and fire safety (ATOC) (superseded in Aug 2008 by GM/RT 2130).	December 2002 to August 2008
GM/RT 2130 (Issues 1 to 5 inc.) - Vehicle fire, safety and evacuation.	June 2008 to June 2020
RIS 2730 (Issue 1) - Vehicle fire safety and evacuation.	June 2020 onwards
BS EN 45545 - Railway applications - Fire protection on rail vehicles.	2013 onwards

Table 8: Fire standards reviewed by RAIB

549 Coach B caught fire after coming to rest on the embankment flank with its right-hand side on the ground and sloping so its leading end was lower than its trailing end. The fire was not apparent to witnesses until around 11:00 hrs (approximately 90 minutes after the accident). Photographs indicate that no fire was apparent before 10:22 hrs, but by 11:09 hrs a significant fire had developed around the battery box (figure 88). The following paragraphs describe the evidence showing that this was the source of the fire which then entered the coach through a floor opening, required for the ventilation system, before spreading up towards the rear of the coach.



Figure 88: Coach B on fire at 11:09 hrs (Mark Davidson)

550 Coach B equipment included auxiliary batteries located in a battery compartment on the right-hand side of the underframe, between one-third and halfway along the coach from the front. The battery compartment contained 48 individual lead-acid cells, each of which contains 2 kg of a polymer material. These individual cells are packaged in groups of four, each group contained within a polymer box containing sheets of polymer honeycomb (figure 89).

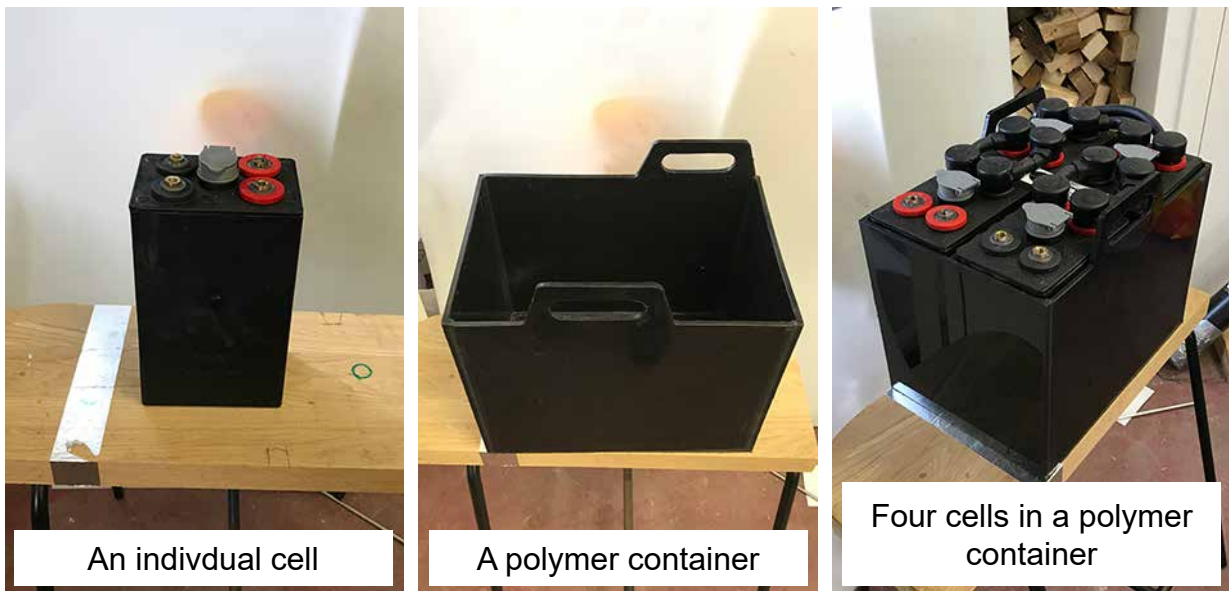

Figure 89: Coach B auxiliary battery arrangement

- 551 In order to understand any possible contribution that the batteries may have made to the development and ultimate size of the fire, a series of laboratory tests, including Cone calorimeter tests to BS ISO 5660-1:2015,<sup>66</sup> were conducted to establish how the materials used in the batteries and associated containers reacted to fire.
- 552 The tests showed that the polymer battery boxes and cell casing materials are easily ignited, sustain burning at ambient temperature, generally burn until little of the material remains, and burn with a comparatively high heat release rate.
- 553 The remains of some battery cells were observed at the accident site adjacent to the left-hand side of the rear of the trailing power car. It is believed that they became detached from coach B as it left the track. These cells had been completely destroyed by fire, to the extent that no unburned plastic remained amongst the debris. This demonstrated the ability of these materials to sustain a fire remote from other heat and ignition sources.
- 554 The means by which the cells, both those detached from and those remaining within, the battery box, were ignited has not been established. The destruction caused by the fire made this impractical. However, the Fire Research Centre reported that it seems probable that the underframe of coach B sustained mechanical damage as the coach was derailing. Such contact would have damaged cells, and electrical wiring, probably shedding battery acid and possibly resulting in friction heating as the underframe was dragged along the rails.
- 555 Electrical heating and/or sparking due to damage caused to electrical circuits are likely to explain the ignition of the battery materials. The large thermal mass (the ability to absorb and store energy) of the lead plates within the cells is considered likely to be the main factor that delayed the growth of the fire, and therefore resulted in the significant time period before combustion was observed on site.
- 556 A heating, ventilation and air conditioning (HVAC) system was mounted on the underframe of coach B, located near to the middle of the coach. Air from this system was supplied to the passenger compartment through sheet metal ducting leading to two rectangular holes in the floor of the coach, one on each side near the centre of the vehicle. Once inside the coach, air was directed along a vented duct running along the floor of the coach where it meets the bodyside. No evidence of any fire damage was found on the HVAC unit, and so this is discounted as the source of the fire.

---

<sup>66</sup> ISO 5660-1:2015 Reaction-to-fire tests — Heat release, smoke production and mass loss rate — Part 1: Heat release rate (cone calorimeter method) and smoke production rate (dynamic measurement).

557 The subsequent spread of the fire was a result of the coach coming to rest on its right-hand side on the slope, with its trailing end uppermost. This orientation meant that the fire naturally extended across the underframe and grew towards the trailing end of the coach. The rectangular hole on the left-hand side, designed to allow air from the HVAC system into the passenger compartment, was likely likely to have been the route of the fire into the coach's interior. This hole, measuring approximately 280 mm by 160 mm, is 2.4 metres away from the battery box, diagonally across the underframe.<sup>67</sup> It was exposed during the accident because the lightweight sheet metal ducting previously connected to it was stripped away from the underframe during the accident. The hole with evidence of surrounding fire damage is shown in figure 90.

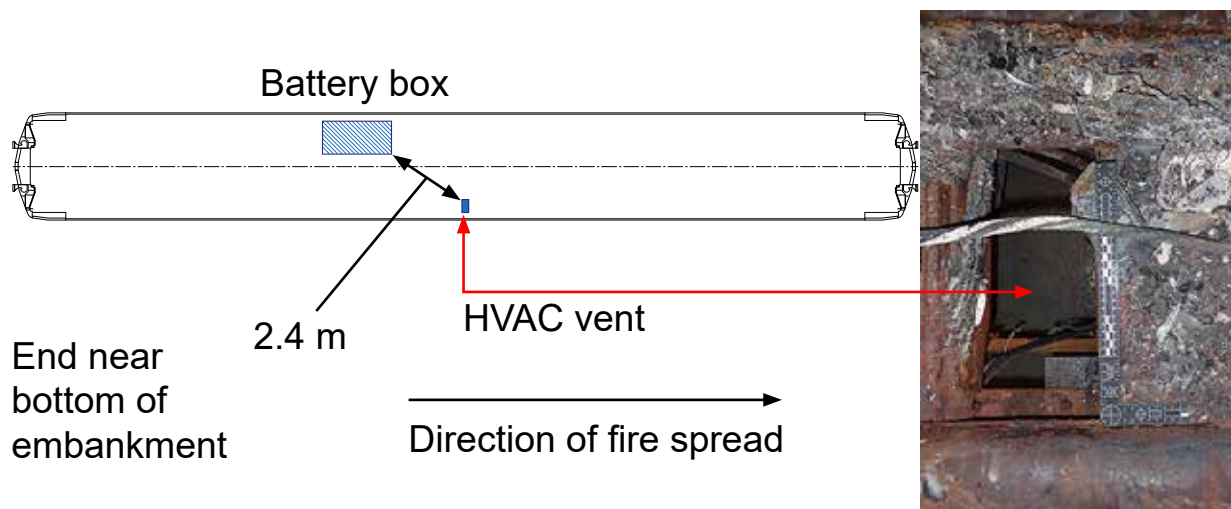

Figure 90: Opening for ventilation system in coach B floor

558 The leading end of the coach, below the battery box in the coach's resting position, was not significantly damaged by fire (figure 91). The glass panels in the five rearmost (of eight) left-hand side bodyside windows were destroyed. A photograph of them before the fire developed shows they were still intact approximately 1 hour and 40 minutes after the coach came to rest, so it is most likely that they were damaged by the fire as it spread through the coach's interior. The fire destroyed the rear two-thirds of the coach, with a clear delineation between the damaged and undamaged sections around the battery box. Where they were exposed to fire, the interior fittings were destroyed, with most seats being reduced to heavily oxidised metal frames (figure 92).

### Evacuation

559 It is likely that the passengers at the leading end of coach D were ejected through broken windows as the coach rolled over near the end of its travel. With the assistance of the contractor's staff on site and at least one member of the public, they were helped to safety and subsequently taken to hospital.

<sup>67</sup> Modern railway passenger vehicles are designed to be compliant with BS EN 45545, which requires measures to mitigate against the risk of fires spreading into passenger compartments. This includes automatic devices that seal such apertures in the event of fire.



Figure 91: Coach B showing fire damage viewed (a) from bottom of embankment and (b) from overhead

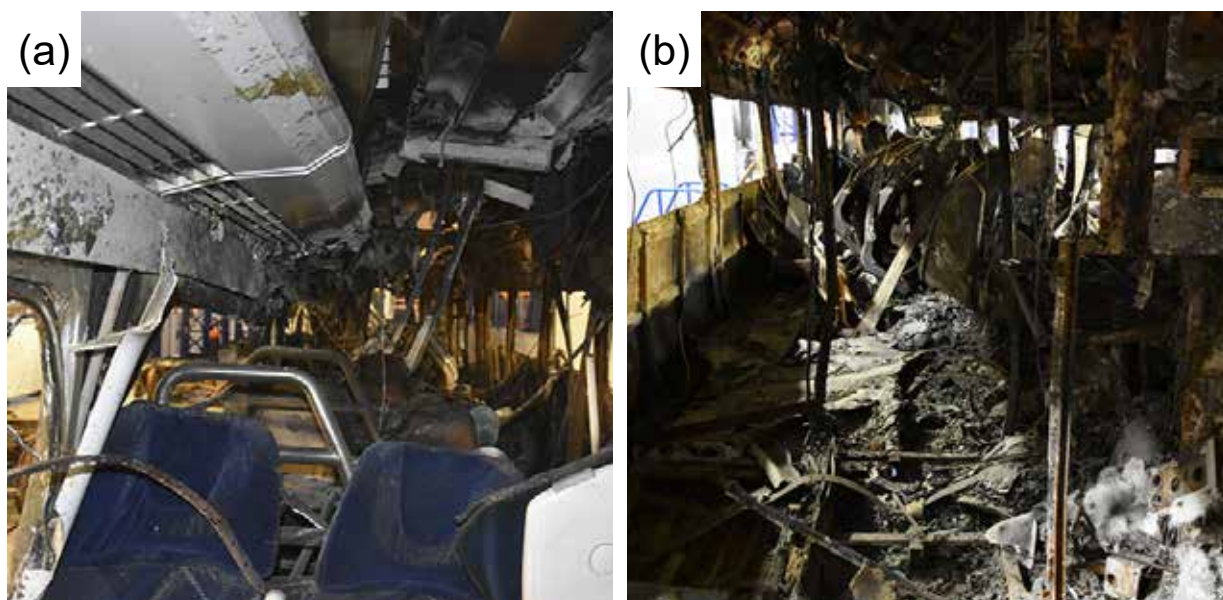

Figure 92: Coach B interior without fire damage at leading end (a) and fire damaged at trailing end (b)

560 The three passengers that had been in the trailing half of coach C (which was upside down and resting on coach D) were able to leave the coach using the open trailing end gangway that was now facing north, to drop down onto the track. One had serious injuries and was helped by the other two. The seriously injured passenger from coach C was taken by helicopter to hospital, and the others by road ambulance.

561 The conductor travelling as a passenger in coach A was able to use the emergency egress handle to open a set of doors at the rear of this coach, and climbed down partially before jumping down to the track.

### Emergency egress

562 Mark 3 coaches have six emergency egress routes comprising a gangway at each end and two doors per side, located at the ends of the vehicle. Bodyside windows are no longer considered a viable exit route on British trains as the glazing is designed to remain in place even when broken (as far as possible), to minimise the risk of passenger ejection.

563 Due to the severe damage of the vehicles and their disposition following the derailment, some emergency exits were not available to survivors: either because they were completely blocked off by debris or the doors were jammed and could not be opened (after activation of the emergency door release), most likely due to distortion of the body structure.

564 Post-accident inspections of the train after it was removed from the accident site were undertaken to determine the status of the egress routes, taking into account the disposition of the vehicles on site. The forces required to manually open the doors after activating the emergency door release (where possible) were also measured. Those which required a greater force than 250 Newtons (25 kg force) were considered too difficult to open and considered unavailable. Figure 93 shows the available egress routes.

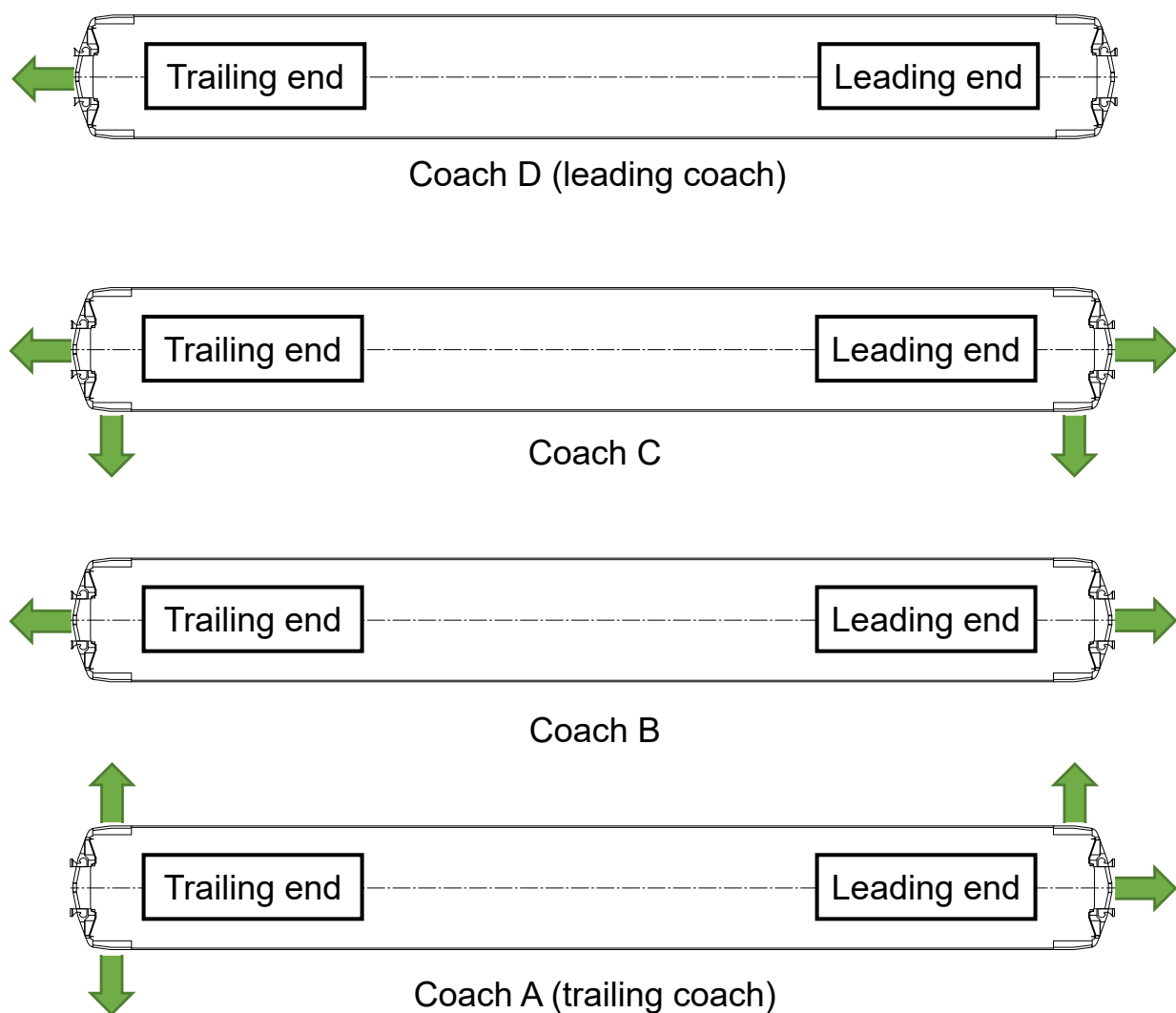

Figure 93: Egress routes available to survivors from each vehicle



565 Coach D only had only one egress route available (discounting broken windows). All the other coaches had a minimum of two routes available. Coach B, which had rolled onto its side, only had two routes because the doors on the low side were blocked and those on the high side would have been difficult to open due to their position above anyone in the coach. There were no egress issues resulting from the power door modifications to the mark 3 coaches.

## Observations

### Route proving

#### **566 Railway industry processes for the operation of route proving trains were poorly defined and inconsistent.**

- 567 During the course of the morning of 12 August, the ScotRail DOM at route control decided that train 1T06, the 05:36 hrs Aberdeen to Glasgow Queen Street service, would be used for 'route proving'. Neither ScotRail nor Network Rail have been able to identify a formal documented record of the reason for this decision; witness evidence indicates that it was made due to concerns about the risk to passenger welfare on trains which might have become stranded between stations.
- 568 As a result of weather-related issues on the railway more generally in Scotland, it was not anticipated that train 1T06 would proceed beyond Dundee. At 05:32 hrs, a member of ScotRail staff at route control telephoned staff at Aberdeen station to advise them that 1T06 would operate without conveying passengers, and the train was redesignated as 5T06. The station staff advised the traincrew and the few passengers who were expecting to travel on the train.
- 569 Train 5T06 was not the first train to operate on the Aberdeen to Dundee railway on the morning of 12 August. Train 2B12, the 05:06 hrs Aberdeen to Montrose service, had already departed; this train arrived at Montrose at 05:51 hrs having encountered no problems during its journey. From the south, train 1H25, the 05:39 hrs Dundee to Inverness via Aberdeen service, departed from Dundee at approximately the same time as 5T06 left Aberdeen; these two trains passed each a short distance south of Montrose. With the exception of about 3 km (2 miles) south of Montrose, the route proving train was on a route (not necessarily the same track) which had been 'proved' earlier in the day by a previous train.
- 570 At 05:38 hrs, the driver of 5T06 made a call using the GSM-R cab radio system to the DOM in route control seeking confirmation of route proving requirements. The manager advised the driver that he should "*drive at a speed which you deem safe to do so*"; the driver replied "*OK, just wanted to double check*". Duty operations manager training does not explicitly cover route proving, but does deal with management of stranded trains.
- 571 Train running records show that train 5T06 passed Stonehaven six minutes behind the schedule for the passenger train 1T06; the train was seven minutes behind schedule passing Carmont signal box, but it arrived at Dundee on time at the scheduled time (for 1T06) of 06:46 hrs.

572 Network Rail's sectional appendix for Scotland<sup>68</sup> provides some information on the operation of route proving trains. This document states that a *'route proving run is conducted to assess the integrity of the infrastructure before the restoration of normal train services'*. The sectional appendix further states that:

- *'Network Rail control will contact the controlling signal box and brief the signaller on the planned route proving services.'*
- *'The signaller will advise each driver in charge of a route proving train before the commencement of the journey that they are being used to prove the route and the sections of line(s) which need to be proved.'*
- *'Route proving drivers will proceed over the affected portion of line at caution and prepared to stop short of obstructions.'*

573 The operation of train 5T06 on the morning of 12 August was inconsistent with the sectional appendix instructions. The decision to 'route prove' was made by ScotRail, not by Network Rail. The advice to the driver came via station staff, with no involvement from signallers, and the train running times show that the train was not operated at caution;<sup>69</sup> it ran at the timings which would be expected for a train in passenger service.

574 RAIB has established that the concept of 'route proving trains' is widely used as a risk mitigation throughout Great Britain. Typically, a route proving train is run after engineering works, following adverse weather, or after a route has been closed for a significant period. However, the description of 'route proving' contained in the Scotland sectional appendix is unique to Scotland; neither the railway Rule Book, nor the sectional appendices covering other parts of Britain contain guidance or instructions for the operation of route proving trains.

575 Despite the widespread use of route proving trains, there are no documented rules for the operation of such trains and the expectations placed on their drivers. It is unclear whether (or when) a driver is expected to 'route prove' adjacent track(s) in addition to the one their train is traversing, and unclear in what circumstances (if any) that route proving can take place at night.

576 Module TW1 of the Rule Book covers 'examining the line'. However, this concept differs significantly from the apparent expectations of 'route proving'. 'Examining the line' is implemented by instruction from a signaller to a driver in response to a known, or suspected, specific problem and requires drivers to drive at 'caution' (a speed which allows them to stop before an obstruction). This differs from 'route proving' which is intended to establish or confirm the condition of a route when there is no specific information about a known or suspected problem.

<sup>68</sup> NR30018/4, 'Scotland Route Sectional Appendix to the working timetable and books of rules and regulations'. Route proving is covered by an instruction dated 25/01/2020.

<sup>69</sup> The rules for driving 'at caution' were covered by module TW1 (issue 14) of the railway Rule Book. These required drivers to proceed at a speed which takes account of conditions and will allow them to stop the train short of any obstruction.

## Emergency communication

### **577 Use of the GSM-R radio system by ScotRail staff would have broadcast emergency information to other railway staff more quickly.**

578 All trains operating on the national rail network are equipped with the GSM-R cab radio system. This includes the ‘railway emergency group call’ (REC) facility which sends a ‘stop’ message to the drivers of all trains in the local area and connects the caller to the signaller responsible for the area in which the train is travelling. Using this facility also broadcasts the call to the drivers of other trains in the area and to route control staff.

579 The GSM-R cab radio is registered on the network by the driver when a driving cab is activated; this identifies the train using its reporting number and allows signallers to contact the driver directly. The radio is powered down in inactive cabs, such as in the trailing power car of an HST. However, it is possible to power it up and use the REC facility in an emergency situation without activating the cab or registering the radio first.

580 The railway Rule Book contains a number of requirements about drivers (and in some situations, guards or conductors) contacting signallers as quickly as possible in the event of flooding, obstructions of the line, accidents or emergencies.<sup>70</sup> Although the REC facility of the GSM-R system will usually be the quickest and most effective way of contacting the signaller, the only explicit requirement to use it is when other trains are put in danger, including by an obstruction of the line (section 43.1 of module TW1).

### Driver of 2B13

581 The driver of train 2B13 passed the site of the landslip blocking the up line at Ironies Bridge at 06:57:57 hrs. He was approaching Carmont signal box and started sounding a series of short blasts using the train’s horn to attract the signaller’s attention<sup>71</sup> at 06:58:56 hrs; he also flashed the red tail lights at the front of the train (where they would not normally be illuminated). He reported the obstruction to the signaller after stopping at the signal box at 07:00:08 hrs, two minutes after passing the landslip. Train 1T08 passed Carmont signal box at 07:00:26 hrs, travelling towards the landslip at 66 mph (106 km/h). Witness evidence indicates that the signaller ran back into the signal box and started a call to alert the driver of 1T08 using the REC facility at 07:00:35 hrs. The driver of 1T08 stopped the train about 570 metres short of the landslip at 07:01:11 hrs; this distance is equivalent to 20 seconds’ travelling time at 66 mph (106 km/h).

### Conductor travelling as passenger

582 Immediately after the accident, the conductor travelling as a passenger on train 1T08 made a 999 call from her mobile phone, during which the emergency services operator advised her to get off the coach. She then walked towards Carmont signal box, and was first able to contact the signaller from a lineside telephone at 10:15 hrs, after walking about 1.7 km (1.1 miles) (paragraph 65).

<sup>70</sup> Relevant sections of the Rule Book include section 4.1 of module M3, section 43.1 of module TW1, section 4.1 of module G1, section 2.1 of module M1 and section 39.2 of module TW1.

<sup>71</sup> The ‘train in distress’ warning described at section 38 of Rule Book module TW1.

583 Her training and assessment to act as a conductor on HSTs had not included where to find the GSM-R equipment in the cab of an HST power car, and witness evidence indicates that she had never been in an HST cab. Even if her training had included the location of the GSM-R equipment, it would not have been possible for her to her to use it. The trailing power car had come to rest alongside the leading power car which was on fire before she alighted from her coach. Additionally, she had lost her train keys in the accident (needed for her to access the driving cab) and had sustained an ankle injury.

### Earthworks inspections

**584 Network Rail's standard relating to the examination of mixed cuttings was open to differing interpretations, and so left a potential gap in the management of risk from soil components of mixed slopes. Although it was generally understood by local examiners that it was desirable to traverse the slope of a mixed cutting to view it from the bottom and top, the inability to do so was not always reported to Network Rail.**

585 Network Rail procedures require routine examinations of cuttings, such as that at Carmont, to identify their condition and to trigger appropriate remedial action where needed. The earthworks examinations were undertaken on behalf of Network Rail by staff employed by Amey. Amey had been awarded the Civils Examination Framework Agreement (CEFA) contract for earthworks examinations for Scotland for Network Rail's control period 5 (2014-2019). The contract had been extended and remained in place in 2020.

586 The section of cutting in the area of the washout was last examined on 14 June 2020, and this inspection resulted in the slope being assigned a 'low to medium' likelihood of failure. It was assigned an earthworks hazard category of C on a scale from A (lowest risk) to E. This was based on the condition of the soil cutting scoring C and the underlying rock slope section scored B. The examiner found no serious issues, such as water flowing over the top of the cutting.

587 A previous examination report, from January 2017, recorded 'drain flowing freely', based on the examiner seeing water flowing from the outlet at track level. This examination resulted in the cutting slope being classified as C. The preceding examination, in February 2015, also classified the slope as C and stated that the crest drainage was a 'french drain' and was 'free draining'. Since earthworks examiners are not given any information on drainage arrangements and are not expected to open catchpits, observations of drain flows are affected by weather conditions.

588 Network Rail standard NR/L3/CIV/065<sup>72</sup> describes the required examination process. Earthworks are considered in 5-chain (about 100 metre) lengths with each length being the subject of a separate report. Clause 5.10 of standard NR/L3/CIV/065 described 'soil slope' examinations as requiring an examiner to traverse a slope (from bottom to top) at three locations, not more than 2 chains (40 metres) apart, over each 5-chain length. Furthermore, appendix B to the standard, which related only to soil slopes, required the examiner to record evidence, including the effectiveness of drainage systems, in order to calculate a soil cutting hazard index (SCHl), or an equivalent for embankments.<sup>73</sup>

<sup>72</sup> Standard NR/L3/CIV/065 issue 6 published September 2017 'Examination of earthworks manual'.

<sup>73</sup> SCHl is an index calculated using numerical values assigned to slope-related features.

589 Clause 5.12 of this standard covered the examination of mixed cuttings. These are cuttings with both soil and rock slopes, such as at Carmont, where the cutting was excavated through soil (glacial till) and the underlying rock (Carron sandstone).

590 Clause 5.12 states that:

*‘where cutting failure modes are likely to be due to shear strength of soil then a SCHI examination will be carried out.’*

591 It also states that examiners should:

*‘gather and record data to enable hazard index scores to be determined for both soil and rock components’.*

592 In describing requirements for mixed cuttings, clause 5.12 does not state how data required for the SCHI calculation should be obtained, does not explicitly refer to ‘soil slope’ examinations and does not explicitly state that examiners of mixed slopes should traverse the slope from bottom to top (as is required by clause 5.10 for soil cuttings and which provides examiners with an opportunity to view the cutting crest). Guidance on data needed to populate the SCHI is provided in Module 02 of NR/L3/CIV/065.<sup>74</sup> This includes data relating to the type, size and gradient of slope crest drainage, together with an assessment of how well this was conveying water. The crest drainage elements of SCHI did not require further information to be gathered about drain condition.

593 Module 02 states that the majority of parameters needed to calculate the SCHI should be determined by field observation of the cutting and adjacent areas. It also states that a small number of parameters can only be determined from desk study. A desk study would not be a reliable way of obtaining some information which would only be seen by visiting a cutting crest.

594 Witness evidence confirms RAIB’s view that the requirements documented in standard NR/L3/CIV/065 relating to mixed cuttings were unclear in respect of whether the examiner should traverse the slope (or visit the crest by another route) in order to report the examination as complete. This lack of clear instruction left a potential gap in the management of risk from soil components of mixed slopes. Nevertheless, it was generally understood by examiners that it was desirable to traverse the slope and/or view a cutting from the top.

595 Witness evidence indicates it is likely that during the earthwork examinations at Carmont, the cutting face was only viewed from at or near track level. This meant that the examiners could not examine the surface above the drain, except for the lowest section and the section leading to its outlet. Examiners understood they were not required to climb to the top of the cutting unless they considered this to be practicable and safe. Despite traverses being impossible due to the steep rock face, and the likely lack of visits to the cutting crest (except at its lowest part), both the examiners and Network Rail considered the examinations at Carmont to be complete and in accordance with the requirements for examination of a mixed cutting.

---

<sup>74</sup> NR/L3/CIV/065 module 02, ‘Definition of soil cutting hazard index’, issue 1, dated 2 September 2017.

596 As explained in paragraph 595, Amey staff had not marked their examination reports as incomplete. Had they done so, Clause 5.16 of standard NR/L3/CIV/065 required that a risk evaluation be carried out to identify any interventions or mitigating measures which needed to be implemented before completion of the examination.

597 Had Amey staff reported the inspections as incomplete it is possible that, following a risk assessment, dispensation would have been granted to view the slope by remote means from track level, or from the top of the slope, or that access would be enabled by rope or some other means. However, it is far from certain that any issue with the drain which might have existed at the time of an examination would have been observed and recognised as a risk to the railway. The reasons for this are as follows:

- Earthwork examiners would be focused on slope condition, and are only required to observe any obvious evidence of the effectiveness of drainage systems. They were not tasked, trained or provided with the information needed to carry out a detailed evaluation of drainage system condition.
- Any examiners accessing the slope by rope, or some other means, would not necessarily see the drainage trench at the point at which any issue would have been apparent.

598 RAIB has evidence to suggest that the number of geotechnical roped access inspections undertaken in Scotland in 2018/19 and 2019/20 was significantly less than in another Network Rail route. There is no apparent technical explanation for this difference.

## The role of the safety regulator

599 The Office of Rail and Road (ORR) regulates the railway industry's health and safety performance. Its role includes the monitoring of health and safety performance, carrying out inspections and taking action to enforce compliance with health and safety law. ORR is also tasked with ensuring that appropriate action is taken in response to RAIB recommendations.

600 ORR plans its routine work on the basis of risk and its analysis of where it can secure the most significant improvements in safety management. Its inspections and assessments aim to draw systemic conclusions which will promote improved safety arrangements across a wide range of activities, rather than only identifying specific shortcomings.

## Earthwork management

601 Earthwork failures in late 2011 and early 2012 resulted in Network Rail informing ORR that the report commissioned by Scotland Route in 2012 (paragraph 311) would include consideration of earthwork risk due to extreme weather. ORR notes of a meeting with Network Rail on 19 July 2012 show that the review did not cover this issue to ORR's satisfaction and an improvement notice<sup>75</sup> covering earthworks failures in Scotland during adverse weather was issued on 3 August 2012.<sup>76</sup> Network Rail responded by implementing a more structured approach to the identification of earthworks to be included on the 'at risk' register, which considered both the likelihood of an earthwork failure and the potential consequence (this applied in Scotland and all other routes). ORR considered that this addressed the concern raised in the improvement notice and recorded a compliance date of 14 December 2012.

602 ORR publishes a strategy for regulation of health and safety risks in which chapter 6b covers civil engineering assets and, before the accident at Carmont, was last updated in April 2017.<sup>77</sup> This document clearly articulated ORR's concerns about the significant risk posed by earthwork and drainage assets, and describes its regulatory strategy as summarised below:

- Engage with the industry to ensure increasing understanding of the relationship between asset condition, consequences of failure and control of risk, and the need for improved asset knowledge.
- Ensure that improved industry intelligence about likelihood and consequence of failure informs prioritised programmes of renewal to modern resilient designs – and underpins interim contingency arrangements to mitigate the effects of failure.
- Promote industry adoption of appropriate asset management regimes.
- Encourage the industry to improve engineering innovation so that there is a reduction in the reliance on human systems.
- Engage with industry to secure a suitable system engineering approach to the management of civil engineering assets.

---

<sup>75</sup> 'Improvement notices' are issued by ORR when an inspector is of the opinion that an organisation is not complying with Health and Safety legislation. Improvement notices are used to ensure that statutory standards for health, safety and welfare are complied with and will specify the time period for compliance.

<sup>76</sup> Enforcement notice reference I/ENF-NOT-57/JPMcG.

<sup>77</sup> 'Strategy for regulation of health and safety risks - chapter 6b: Civil Engineering Assets', published by ORR in April 2017.

### Construction activities

- 603 In response to an RAIB request for information about ORR activities relating to construction work in the five-year period commencing in April 2009, ORR stated that, on the basis of risk, it did not always allocate a great deal of time and resource to major works/capital projects and, where it did so, the resource was directed towards the front end of the processes (risk assessment and option selection) where shortcomings can be very troublesome and expensive to rectify. CDM compliance was among topics assessed by ORR, and areas of concern related to the early stages of this process, particularly how Network Rail was addressing the client role responsibilities. During this five-year period, ORR identified concerns about Network Rail assurance processes relating to track work, and expected the resulting improvements to feed into other Network Rail disciplines.
- 604 Witness evidence (as documented records no longer exist) refers to ORR assessing Network Rail's process for transferring signalling assets from the installation phase into the maintenance phase. The underlying process for doing this (NR/L3/MTC/089) also applied to civil engineering works such as the Carmont drain. ORR's consideration of the signalling transfer process took place in around 2009/10 and identified patchy achievement of the requirement to provide accurate and timely 'as-built' drawings, sometimes due to practical issues and sometimes apparently due to it not being given a high priority. Although it no longer holds records of feedback given to Network Rail, ORR believes that the processes were generally fit for purpose provided the mandated processes were applied more consistently and rigorously.
- 605 ORR's role does not normally include direct oversight of construction work, although a small number of sites are visited as part of ORR health and safety inspection activities. Therefore, even if ORR had applied significantly greater resource to monitoring of construction work, it is extremely unlikely that this would have directly identified the uncontrolled design changes at Carmont.

### Recommendation handling

- 606 ORR stated that it assesses the actions taken in response to RAIB recommendations against clear criteria, with inputs from specialist expertise as appropriate. This assessment is based on the information provided by the organisation required to implement the recommendation. ORR does not routinely carry out formal assurance to see if an 'end-implementer' is continuing to do what they said they were doing in response to a recommendation. However, ORR does look at implementers' actions if these coincide with ORR's inspection priorities (paragraph 600). This approach reflects ORR's position that responsibility for controlling risks lies with the duty holder. The information provided to ORR in respect of selected recommendations relevant to events at Carmont is discussed at paragraph 397 onwards.



## Other occurrences

- 607 RAIB investigations referenced in this report are listed in appendix L.
- 608 The Carmont accident site is in the area subject to a temporary speed restriction which was exceeded by six trains on 4 December 2020. A 40 mph (64 km/h) 'blanket' emergency speed restriction had been imposed between Laurencekirk and Portlethen because of a forecast of heavy rain with the associated risk of an earthwork failure obstructing the line. Fortunately, no earthwork failures actually occurred so there were no physical consequences from this incident. RAIB's investigation ([RAIB report 08/2021](#) published on 15 November 2021) into these speeding incidents found that Network Rail had introduced a nationwide process for implementing 'blanket' emergency speed restrictions after the Carmont accident to reduce the likelihood of another accident due to similar causes. However, RAIB concluded that the railway industry needed to do more work to establish a suitable method for the imposition of speed restrictions in these circumstances, and issued a recommendation addressing this issue.
- 609 The circumstances of a parapet failure on 15 January 2021 at bridge 328, on the line from Carmont to Stonehaven and about 1.6 km (1 mile) north-east of the accident site, were reviewed by RAIB to establish whether there was any overlap with factors relating to the Carmont accident. RAIB concluded there was no such overlap (appendix M).

## Summary of conclusions

### Immediate cause

610 Train 1T08 derailed because it struck washout debris (paragraph 72).

### Causal factors

611 RAIB's investigation concluded that had the drainage system been installed in accordance with the design it is highly likely to have safely accommodated the flow of surface water on 12 August 2020. However, as installed, the drainage system was unable to do so (paragraph 91). This occurred because:

- a) The gravel in the drainage trench was vulnerable to washout if large flows of surface water concentrated onto a short length of drain (paragraph 100, **Recommendation 3**).
- b) Carillion did not construct the drain in accordance with the designer's requirements (paragraph 114, **Recommendation 1**).

612 RAIB also identified the following possible causal factors:

- a) Network Rail's project team were probably unaware that the 2011/12 drain was significantly different from that intended by the designer and therefore did not take action. Had the team been aware of this, it is possible that the consequent risk would have been recognised and remedial actions taken (paragraph 160, **Recommendation 1**).
- b) Network Rail's processes that were intended to ensure a managed transfer of safety related information from constructor to infrastructure manager were ineffective. Had this managed transfer taken place in accordance with Network Rail's processes, it is possible that the divergence between the design intent and the asset that had been delivered would have been noted and remedial action taken (paragraph 179, **Recommendations 1 and 2**).
- c) No action was taken by Network Rail or Carillion when water flow in gully 1 caused slight erosion to the gravel surface of the new drainage trench before the works were completed. This was a missed opportunity to recognise the effect of the bund on water flows and is therefore considered to be a possible causal factor in this accident (paragraph 185, **Recommendation 1**).

613 With regard to railway operations, RAIB identified the following causal factors:

- a) Network Rail did not have suitable arrangements in place to allow timely and effective adoption of additional operational mitigations in case of extreme rainfall which could not be accurately forecast (paragraph 189, **Recommendations 6 and 7**).
- b) Although aware of multiple safety related events caused by heavy rain, route control staff were not required to, and did not, restrict the speed of train 1T08 on its northward journey from Carmont to Stonehaven (paragraph 225, **Recommendations 6 and 7**).

- c) The signaller and driver were not required to, and consequently did not, restrict the speed of train 1T08 to below that normally permitted (paragraph 246, **Recommendation 6**).

## Consideration of other issues

614 The following issues cannot be completely discounted as factors in the Carmont accident, but available evidence is insufficient to consider them to be causal. In other circumstances, they could have been a factor in an accident:

- a) HST lifeguards were less robust than those on more modern trains. Although a stronger modern lifeguard may have been better able to move sufficient washout debris out of the path of the leading wheelset to prevent the derailment, RAIB had insufficient evidence to determine the likelihood of this happening (paragraph 267, **Recommendation 14**).
- b) Network Rail's process for initiating the inspection and maintenance of new drainage works had not been correctly applied. Consequently, it is likely that the upper section of the 2011/12 drainage system had never been inspected since its completion. Although RAIB has found no evidence to suggest that such an inspection would have changed the outcome, this cannot be entirely discounted. Whether or not relevant to the accident, the absence of proper inspection of a safety critical asset is of great concern (paragraph 275, **Recommendation 2**).
- c) Neither RAIB or Network Rail could find any trace of the health and safety file for the Carmont drainage works. There is evidence that Network Rail's processes related to the creation and management of health and safety files were not being correctly applied in Scotland and elsewhere in the UK (paragraph 287, **Recommendation 2**).
- d) Custom and practice in Scotland's route control meant that extreme weather action team (EWAT) meetings were not always convened when required by Network Rail's processes, and no such meeting was called on 11 or 12 August 2020 despite forecasts of severe weather. However, even had an EWAT been convened it is considered unlikely that Network Rail would have taken the actions needed to avoid the accident (paragraph 298, **Recommendations 6 and 7**).

## Underlying factors

615 RAIB's investigation identified the following underlying factors:

- a) Network Rail's management processes had not addressed weaknesses in the way it mitigated the consequences of extreme rainfall events (paragraph 318). The underlying reasons for this were:
  - i. Despite an increasing awareness of the threat, Network Rail had not sufficiently recognised that its existing measures did not fully address the risk from extreme rainfall events, such as summer convective storms. Consequently, areas of significant weakness had not been addressed (paragraph 336, **Recommendations 6 and 10**).

- ii. Network Rail's management assurance processes did not highlight the extent of any areas of weakness in the implementation of extreme weather processes in route controls, or that the controllers lacked the necessary skills and resources to effectively manage complex weather-related situations of the type experienced on 12 August 2020. Consequently, significant areas of weakness in the railway's risk mitigation measures were not fully addressed (paragraph 359, **Recommendation 8**).
  - iii. The railway industry's risk assessments had clearly signalled that earthwork/drainage failure due to extreme rainfall was a significant threat to the safety of the railway. However, they had not clearly identified potential areas of weakness in the existing operational mitigation measures (paragraph 374, **Recommendation 6 and 10**).
- b) Despite an awareness of the risk, Network Rail had not completed the implementation of additional control measures following previous events involving extreme weather and the management of operating incidents. It is possible that better delivery of change in response to safety learning would have resulted in actions that would have prevented, or mitigated, the consequences of the accident at Carmont (paragraph 397, **Recommendation 9** and Margam report recommendation 6).

## Examination of consequences

616 When considering the consequences of the accident, RAIB took into account:

- the circumstances of the derailment; speed, local topography and proximity to a bridge (paragraphs 454 to 459)
- the structural damage to the vehicles (paragraph 462 to 469)
- the unusually low number of people on the train because the accident occurred during the COVID-19 pandemic (paragraphs 460 and 461).

617 The crashworthiness of the vehicles involved in the derailment (paragraph 481 to 483), and the severity and cause of injuries suffered by those on the train (paragraphs 470 to 480) were examined by RAIB. The findings are presented in the following sections of the report:

- a) driver's cab (paragraphs 484 to 490, **Recommendation 17**)
- b) structure of the mark 3 coaches and the effect of corrosion (paragraphs 491 to 501, **Recommendation 18**)
- c) couplers and absence of bogie retention on the coaches (paragraphs 502 to 506, **Recommendation 19**)
- d) vehicle interiors and bodyside mounted folding tables (paragraphs 507 to 517, **Recommendation 16**)
- e) window breakage (paragraphs 518 to 527, **Recommendation 15**)
- f) comparison with modern rolling stock (paragraphs 528 to 535, **Recommendation 19**)
- g) guidance for derailed vehicles (paragraphs 536 to 543, **Recommendations 12 and 13**)

- h) fire causation and effects (paragraphs 544 to 558, **Recommendation 20**)
- i) evacuation of survivors and emergency egress (paragraphs 559 to 565, no recommendation).

### Additional observations

618 Although not linked to the accident on 12 August 2020, RAIB observes that:

- a) Railway industry processes for the operation of route proving trains were poorly defined and inconsistent (paragraph 566, **Recommendation 11**).
- b) Use of the GSM-R radio system by ScotRail staff would have broadcast emergency information to other railway staff more quickly (paragraph 577, **Learning point 1**).
- c) Network Rail's standard relating to the examination of mixed cuttings was open to differing interpretations, and so left a potential gap in the management of risk from soil components of mixed slopes. Although it was generally understood by local examiners that it was desirable to traverse the slope of a mixed cutting to view it from the bottom and top, the inability to do so was not always reported to Network Rail (paragraph 584, **Recommendations 4 and 5**).

## Actions reported as already taken or in progress relevant to this report

### Actions reported that address factors which otherwise would have resulted in a RAIB recommendation

619 ScotRail has stated that it intends to change training for conductors working on HSTs so that it will include entering the driving cab and locating the GSM-R equipment (paragraph 583).

### Other reported actions

620 A new drainage system, with greater capacity than the 2011/12 system and with features intended to prevent another washout, was installed at Carmont to replace the 2011/12 system.

621 Guard rails were fitted on both up and down lines on the approach to bridge 325 when the track was relaid after the accident (figure 86). The protection includes gathering rails (paragraph 537) and, on the down line, extends beyond the site of the washout.

622 Network Rail stated that, before the accident at Carmont, its project teams had started to review historical projects (up to 10-years old) in Scotland to ascertain whether a H&S file, if required, had been accepted by the National Records Group (NRG) and stored appropriately; and this process is continuing. Where it is found that H&S files do not exist for these projects, the relevant asset database (for example Ellipse for a drainage asset) will be interrogated to understand whether sufficient information has been captured to adequately operate and maintain the asset. If that information is sufficient then it will be recorded by the relevant route asset manager and the requirement for a retrospective collation of the information, which would have been contained in the H&S file, will not be required. Where the asset database does not capture sufficient information then, in agreement with the relevant route asset manager, information will be collated to allow the asset database to be populated so the asset can be operated and maintained. NRG will be informed of that decision. The process being applied in Scotland will be presented to the executive leadership team of Network Rail to be adopted nationally.

623 NR Standard NR/L2/INI/02009 was updated and reissued as NR/L2/RSE/02009 issue 7 dated 4 March 2021. This update is intended to strengthen the management of technical queries raised during construction and the process for controlling changes to the design.

624 Network Rail introduced expanded drain design requirements in December 2018 (NR/L2/CIV/005/09) which, in addition to enhanced requirements relating to selection of design methodologies, requires consideration of impacts on other assets, such as earthworks and track, during extreme events. Specific requirements are included if exceedance of design capacity could have catastrophic operational consequences. However, the standard does not explicitly state whether consequences beyond flooding (for example, a washout onto the track), should be considered.

- 625 Scotland's Railway has established a permanently staffed weather desk position. Network Rail has informed RAIB that suitably qualified people have been recruited to cover this position, which is responsible for monitoring weather conditions and advising controllers on the necessary precautionary actions.
- 626 A process requiring blanket speed restrictions in areas without earthworks on the 'at risk' list was implemented, where considered necessary by Network Rail, throughout its network in September 2020. These changes were accompanied by an update to module M3 of the Rule Book (which also introduced revised instructions on the reporting of flooding and earthwork damage). The revised processes included enhanced use of weather data, including an enhanced capability to identify convective rainfall which can be difficult to predict until shortly before it falls. This process formed the background to the event described at paragraph 608.
- 627 Network Rail intends to review whether signallers in remote areas should be provided with the competencies and equipment needed to apply clamps and scotches to secure points. It also intends to resolve the mismatch between the weather thresholds in NOP3.17 and those provided to its weather forecast provider (paragraph 198).
- 628 Following a number of audits that revealed weaknesses in its recommendations management process, Network Rail has implemented a number of process changes that are designed to improve the way that Network Rail manages its response to recommendations (see paragraphs 441 to 447 for details).
- 629 Network Rail has also reported that it is implementing a programme of level 2 audits to check the correct implementation of risk controls that have been introduced in response to previous RAIB recommendations.
- 630 RSSB has commenced a project to assess the effectiveness of blanket speed restrictions in managing and mitigating risks from trains running into trees or landslips (reference T1252). This considers the effectiveness of current UK practice regarding weather-related speed restrictions, and alternative approaches to such speed restrictions that have proved effective in other countries. RSSB has also launched project T1269 'Development of a system risk model for extreme rainfall events'. The project aims to evaluate the risk from collisions and derailments due to extreme rainfall, associated blanket speed restrictions, and knock-on delays, developing a whole system risk model for these events.
- 631 ORR's oversight of work being undertaken by Network Rail in response to learning from the Carmont accident is evident from an exchange of letters between Network Rail and ORR in March and April 2021. ORR provided information about findings emerging from its own investigation, and Network Rail indicated the steps it was taking in response to both this information and its own internal investigation. ORR's acknowledgement refers to close monitoring of Network Rail plans and, where these are merely conceptual at present, a willingness for ORR to help develop these into practical improvements.

### Network Rail Task Forces

- 632 For many decades, Network Rail and its predecessors have been aware of the risk to the infrastructure from extreme rainfall events, including the general risk to assets that are not considered to be at particular risk of failure. However, following the accident at Carmont, and in the light of the likelihood that climate change will exacerbate this risk still further, Network Rail decided to commission two task forces to advise on the ways that it could improve its understanding of earthworks management and potential improvements to its mitigation measures.
- 633 Lord Robert Mair CBE FREng FRS, a geotechnical expert, led an earthworks management task force to advise Network Rail on how it can improve the management of its earthworks portfolio, looking at past incidents, latest technologies and innovations and best practice from across the globe.
- 634 In parallel, Dame Julia Slingo FRS, former chief scientist at the Met Office, led a weather action task force with the objective of better equipping Network Rail to understand the risk of rainfall to its infrastructure, drawing on the latest scientific developments in monitoring, real-time observations and weather forecasting.
- 635 Both task forces issued reports in February 2021 which have been reviewed by RAIB as part of its investigation into the factors that caused the accident at Carmont. The weather action task force report is to be found at:  
[Network Rail Weather Advisory Task Force Final Report](#)
- 636 The earthworks management task force report is to be found at:  
[Network Rail Earthworks Review Final Report](#)
- 637 Neither task force was asked to investigate the accident at Carmont in any detail. However, their findings will inform Network Rail's ongoing asset management and operational mitigation strategies. The work of the task forces therefore complements that of RAIB which relates more closely to the specific factors that contributed to the accident at Carmont.



## Recommendations and learning point

### Recommendations

638 The following recommendations are made:<sup>78</sup>

- 1 *This recommendation recognises the evolution of Network Rail's processes since the Carmont 2011/12 drainage scheme was constructed and is intended to ensure that current processes ensure works are appropriately constructed and transferred into maintenance regimes with the records needed for safe future management of the asset.*

Network Rail should review its contractual and project management arrangements to identify effective measures to:

- a) substantially reduce the risk of contractors modifying an approved design during construction without the appropriate approvals from the designer, the client and any other body affected by the change
- b) ensure the timely provision of the accurate records needed for future management of the asset.

The review should include consideration of:

- contractual conditions and penalties for non-compliance with mandated process
- assurance and quality control requirements
- change management procedures
- appropriate client checks during construction
- the timely preparation and hand-over of 'as-built' drawings and health and safety files
- the requirements of the Construction (Design and Management) Regulations 2015
- ways of guaranteeing access to asset records should a contractor go out of business

<sup>78</sup> Those identified in the recommendations have a general and ongoing obligation to comply with health and safety legislation and need to take these recommendations into account in ensuring the safety of their employees and others.

Additionally, for the purposes of regulation 12(1) of the Railways (Accident Investigation and Reporting) Regulations 2005, these recommendations are addressed to the Office of Rail and Road to enable it to carry out its duties under regulation 12(2) to:

- (a) ensure that recommendations are duly considered and where appropriate acted upon; and
- (b) report back to RAIB details of any implementation measures, or the reasons why no implementation measures are being taken.

Copies of both the regulations and the accompanying guidance notes (paragraphs 200 to 203) can be found on RAIB's website [www.gov.uk/raib](http://www.gov.uk/raib).

- current levels of compliance and reasons for any significant levels of non-compliance.

The measures identified by the review should be incorporated into Network Rail's contractual and project management systems, and those tasked with implementing the improved arrangements should be provided with clear guidance and suitable briefing (paragraphs 611b, 612a, 612b, 612c).

- 2 *The intent of this recommendation is to identify and correct instances where new works have not been incorporated into appropriate maintenance processes (at present these include Ellipse and Maintenance Scheduled Tasks).*

Network Rail should:

- a) take steps necessary to ensure that all elements of infrastructure constructed in Scotland since 2012 that require routine inspections and maintenance are included in the appropriate asset management processes
- b) dependent on findings from the above activity, extend the timeframe, to an extent determined on the basis of safety risk, to include work constructed before 2012
- c) determine, based on safety risk, the extent to which similar steps are required on Network Rail infrastructure outside Scotland and, if necessary, implement these steps
- d) conduct an audit review covering the implementation of existing arrangements to identify, report and correct asset database management and data quality issues.

(paragraphs 612b, 614b, 614c)

- 3 *The intent of this recommendation is for Network Rail to use learning from events at Carmont and the subsequent investigation of this to improve the design of drainage systems.*

Network Rail should review and update its drainage-related procedures so that the output from the design process takes full account of likely impacts on railway safety due to flooding and/or debris washed from drains and/or surrounding ground. The review should take account of:

- water flow return periods and climate change allowances appropriate for both normal operation of the drain and for assessment of drain performance during more extreme events
- the extent to which site-specific information about topography and ground conditions should be obtained, taking into account the extent to which modern technology (such as LiDAR) can assist this
- the full range of drain types available, including those recently developed

- the circumstances in which each type of drain should be used and the detailed specification necessary to suit particular locations
- potential failure modes such as blocked pipes and catchpits
- preventing flooding and/or material displaced from a drain endangering the safety of train movements, allowing for potential exacerbating factors such as the use of gravel-filled drains on steep slopes.

(paragraph 611a)

**This recommendation may also apply to other infrastructure managers in the UK.**

- 4 *The intent of this recommendation is to evaluate the way that examinations of mixed cuttings are being conducted to ensure that the approaches adopted across the network meet with the intent of the relevant standard.*

Amey and Network Rail should jointly review the way that they are implementing the requirements of standard NR/L3/CIV/065 (and the associated module 02) that relate to mixed cuttings and the reporting of incomplete examinations in order to establish any improvements that are required to working practices during examinations. The review should consider the extent to which working practices are compatible with the intent of the standard, consistent with best practice elsewhere and appropriate for effective management of risk.

The areas for improvement identified by the review shall be implemented by means of a timebound plan (with reference to any improvements to the standard arising from implementation of Recommendation 5).

(paragraph 618c)

- 5 *The intent of this recommendation is to reduce the risk that incomplete examinations are not reported to Network Rail.*

In parallel with the implementation of Recommendation 4, Network Rail's Technical Authority should evaluate the adequacy, and ways of improving the clarity, of standard NR/L3/CIV/065 (and the associated module 02) requirements that relate to the examination of mixed cuttings. Steps should then be taken to improve the clarity of the standard and to incorporate any necessary changes into the examination process.

(paragraph 618c)

- 6 *The intent of this recommendation is that the railway industry should review extreme weather processes and ensure that these adequately address rainfall-related risk at earthworks and drainage assets. The recommendation effectively requires a review of the changes introduced shortly after the accident and an assessment of their effectiveness.*

Network Rail should review and, where necessary, improve its processes for mitigating rainfall-related threats to the integrity of its earthworks and drainage infrastructure which could potentially affect the safe operation of trains. This review should include:

- a) identification of any additional mitigation measures to manage the risk to assets, including those that are not considered to be at particular risk of failure in extreme rain-fall, and the circumstances in which these measures should be applied
- b) identification of enhanced methods for the monitoring and measurement of extreme rain-fall and thresholds for applying and disapplying mitigation measures
- c) consideration of resource availability during extreme events (allowing for any mobilisation time)
- d) a plan for ongoing review of the mitigation measures taking account of technological improvements and changing circumstances
- e) possible extension of learning to other weather conditions and/or other types of asset.

Any improvements to existing processes that are identified by this review should be implemented throughout the network.

(paragraphs 613a, 613b, 613c, 614d, 615a.i, 615a.iii)

- 7 *This recommendation is intended to enhance the ability of route control staff to contribute to the safe operation of a modern railway by making good safety decisions in difficult circumstances based on a holistic assessment of the most relevant information. It is intended to build on the work already undertaken as part of Network Rail's 21st Century Operations programme.*

Network Rail, in conjunction with train operating companies, should review the capability of route control rooms to effectively manage complex, widespread and unusual situations such as abnormal weather conditions and multiple infrastructure failures. This review should consider the steps needed to ensure that route controls have sufficient staff with appropriate skills (technical and non-technical), experience and knowledge, all with clearly defined responsibilities and accountabilities. The review should therefore examine how Network Rail ensures that route control staff are provided with appropriate training, learning and professional development for their roles, supported by means of a comprehensive competence management system, that enables them to feel confident and empowered to make difficult decisions.

As part of this review, Network Rail should also compare its railway control safety-related decision-making frameworks with those in other organisations (such as off-shore exploration and air traffic management) to determine if good practices can be imported into the railway environment.

The review should be used to inform the development of a timebound programme for the implementation of the measures that are needed to develop the incident management capability of route controls (paragraphs 613a, 613b, 614d).

- 8 *The intent of this recommendation is to improve the effectiveness of Network Rail's management assurance processes related to safety critical functions of route control rooms, so that it provides a more realistic assessment of the extent to which mandated safety systems are being correctly applied, and the overall level of safety performance.*

Network Rail, in consultation with staff representatives, should undertake a project to improve the way its management assurance system operates in areas directly affecting the safety critical functions of route control rooms. This project should include an in-depth management review to identify gaps or weaknesses in route control management arrangements and the underlying reasons for any areas of non-compliance that are identified.

The output of this project should include a structured and validated programme, endorsed by the Network Rail board, for implementing the necessary improved management assurance arrangements, and briefing the changes to those on the front line (paragraph 615a.ii).

- 9 *This recommendation is intended to ensure that Network Rail makes effective use of safety learning from previous events.*

Network Rail, in consultation with the Office of Rail and Road, should review the effectiveness of recent changes to its processes for ensuring that appropriate action is taken in response to safety recommendations. The review should aim to identify current obstacles to the thorough implementation of lessons learned from the investigation of previous events, and any additional measures that are needed to address them. As a minimum, the review should consider:

- a) the business process and cultural change needed to ensure that agreed responses to recommendations are implemented in an appropriate and timely manner
- b) ways of encouraging the open and accurate reporting of progress with implementation of agreed action plans
- c) the monitoring and senior management review of the extent to which closed recommendations have been effectively implemented and embedded at a working level.

(paragraph 615b)

- 10 *The intent of this recommendation is to identify and address any further areas of weakness in the mitigating controls that relate to weather-related failures of earthworks, drainage and structures (that is, the right-hand side of Network Rail's 'bow-tie' analyses).*

Network Rail, in conjunction with RSSB, should undertake a detailed and systematic risk assessment of the mitigating controls, including operational responses, that relate to weather-related failures of earthworks, drainage and structures. The purpose of the review shall be to rigorously assess the robustness of each control and to identify any further areas of weakness that warrant further examination.

The output of this risk assessment should then be used to devise a timebound programme to address the areas of weakness identified, so far as is reasonably practicable (paragraphs 615a)i, 615a)iii).

- 11 *The intent of this recommendation is to provide a consistent risk-based approach for establishing when trains are to be run to prove a line is safe for normal use by subsequent services, and the procedures, including the operating speeds, applicable to these trains. Implementation should consider all types of route proving, including if required after engineering works and after a prolonged period when train services are not operated.*

Network Rail, assisted by RSSB and the Rail Delivery Group (RDG) should:

- a) determine the objectives of the operation of route proving trains, including consideration of the risks which the operation of such trains is expected to mitigate, and the risk posed to the operation of route proving trains themselves
  - b) identify the hazards which staff operating such trains are expected to identify, and the responsibilities for reporting any identified hazards
  - c) identify the circumstances (including those not related to weather conditions) in which route proving trains should be operated
  - d) identify how route proving trains should be operated (considering factors such as train speed and the effect of reduced visibility)
  - e) introduce documented processes for implementing these findings.
- (paragraph 618a)

- 12 *The intent of this recommendation is to take account of learning from the Carmont accident in the development of a coherent long-term strategy for derailment mitigation. It is anticipated that implementation of this recommendation will be informed by work, including RSSB project T1143, already undertaken by the rail industry as a result of Recommendation 3 of RAIB's investigation of the Watford derailment.*

RDG and Network Rail, in conjunction with RSSB, should consider and incorporate all relevant learning from the Carmont accident into the assessment of rolling stock and infrastructure design features that can provide guidance to trains when derailed. Particular features to be taken into account include:

- a) the risk of derailment from relatively small landslips and washouts
- b) position of track relative to adjacent ground on which derailed wheels may run (that is, features that can affect the deviation of a derailed train)
- c) proximity to features with the potential to increase the consequence of an accident (bridge parapets, tunnel portals etc)
- d) topography likely to increase the extent of vehicle scatter.

The above-mentioned assessment should then be used to develop a systemic, risk-based strategy for the provision of additional measures for the guidance of derailed trains that takes into account the appropriate balance between infrastructure-based mitigation and vehicle-based mitigation. The strategy should also include a plan for implementation of changes to the appropriate industry standards (paragraph 617g).

- 13 *The intent of this recommendation is to enhance the processes for implementing infrastructure-mounted derailment containment devices (such as guard rails and kerbs) at high-risk locations, including bridges and tunnels (currently covered by standard NR/L2/TRK/2102).*

Network Rail should review and improve its processes linked to the installation of guard rails and containment kerbs so that such derailment containment is available at high-risk locations until such time, if any, when rail vehicles carry onboard devices to perform a similar function.

This review should include:

- a) risk-based criteria for selecting sites for the fitting, or enhancement, of guard rails and containment kerbs, taking into consideration relevant learning from the accident at Carmont
- b) the criteria used to determine the distance guard rails or kerbs should extend on the approach to a risk feature (for example, bridges and tunnels)
- c) the criteria used to determine whether derailment containment should be retrofitted as soon as possible or installed during planned asset renewal.

(paragraph 617g)

- 14 *The intent of the recommendation is to reduce the derailment risk of HST power cars caused by running into obstacles on the track.*

Owners of HST power cars should:

- a) investigate the feasibility of enhancing the strength of the bogie mounted lifeguards to a level as close to modern standards as reasonably practicable
- b) if appropriate, develop a timebound programme for carrying out modifications identified in a).

(paragraph 614a)

- 15 *The intent of this recommendation is to minimise the risk of serious cuts and lacerations to passengers caused by broken glazing in any future accidents.*

RSSB should:

- a) investigate the performance of the bodyside windows on the leading coach of train 1T08 to understand the detachment of large shards of glass into the vehicle interior (including the effects of bodyside deformation) and how this relates to the requirements of relevant standards regarding spalling and passenger containment, and disseminate the findings to owners and operators of both mark 3 coaches and any other relevant rolling stock
- b) in the light of findings from (a), review the current acceptance tests and criteria in railway glazing standards to determine if there are practicable improvements (including retrofit options) that should be made to minimise the quantity and size of broken glass that could enter vehicle interiors in future accidents, without adversely affecting the passenger containment performance of the glazing
- c) where appropriate, integrate practicable improvements into revised standards for railway glazing.

(paragraph 617e)

- 16 *The intent of this recommendation is to minimise the risk of serious injury arising from secondary impact with the vehicle bodyside mounted folding tables fitted at some positions on the ScotRail HST mark 3 coaches.*

Angel Trains, in conjunction with ScotRail, should:

- a) review the design of the bodyside mounted folding tables fitted to train 1T08 with respect to minimising the risk of secondary impact injury in the folded position, and its compliance with the requirements of applicable standards



- b) develop a timebound plan for the modification or replacement of similar tables in trains leased by Angel Trains to a design which does not feature potentially injurious edges.

(paragraph 617d)

**This recommendation may apply to owners of other types of rail vehicles on the UK main line network featuring similar table designs.**

- 17 *The intent of this recommendation is to reduce the risk of injury to drivers due to secondary impact during accidents.*

RSSB should:

- a) review its previous research on fitting secondary impact protection devices for train drivers (including seatbelts) in light of the circumstances of Carmont, future train accident risk (including derailment) and the capabilities of current technology
- b) in consultation with relevant stakeholders, evaluate the case for fitting specific secondary impact protection devices into new and existing trains
- c) where justified by a) and b), incorporate requirements for improved protection measures into standards for train driving cabs.

(paragraph 617a)

- 18 *The intent of this recommendation is for corrosion limits in maintenance and overhaul plans to be based on an adequate engineering analysis so that ageing rail vehicles retain their structural integrity to original design standards.*

Owners of mark 3 coaches and other rail vehicle fleets susceptible to significant levels of corrosion and operating on the mainline network, should develop and implement a timebound plan to:

- a) Review vehicle maintenance and overhaul plans to check there are clear criteria in place for the allowable extent of corrosion in safety critical areas. These criteria should be supported by an adequate engineering assessment that takes into account the intervals between corrosion inspections, so that vehicles maintain compliance with their original structural design load cases throughout their service life.
- b) Amend vehicle maintenance and overhaul procedures as necessary to take account of findings from the review in a) and any practical issues with inspection of areas which are not normally readily accessible.

(paragraph 617b)

- 19 *The intent of this recommendation is to evaluate the additional risk to train occupants associated with the continued operation of HSTs, which entered service before modern crashworthiness standards were introduced in July 1994. This will enable the future planning of HST deployment to be informed by a fuller understanding of any additional risk and the costs and safety benefits of any potential mitigation measures. This learning should also inform thinking about the mitigation of similar risks associated with the operation of other types of main line rolling stock.*

Operators of HSTs, in consultation with train owners, ORR, DfT, devolved nations' transport agencies and RSSB should do the following:

- a) Assess the additional risk to train occupants associated with the lack of certain modern crashworthiness features compared to trains compliant with Railway Group Standard GM/RT2100 issue 1 (July 1994), also taking account of age-related factors affecting condition (such as corrosion). This assessment should include a review of previous crashworthiness research (including driver safety), a review of previous accidents, consideration of future train accident risk, the findings presented in this report and any relevant engineering assessments.
- b) Based on the outcome of a) and cost benefit analysis, identify reasonably practicable measures to control any identified areas of additional risk for HSTs, and develop a risk-based methodology for determining whether, and if so when, HSTs should be modified, redeployed or withdrawn from service.
- c) In consultation with operators of other pre-1994 passenger rolling stock, develop and issue formalised industry guidance for assessing and mitigating the risk associated with the continued operation of HSTs and other types of main line passenger rolling stock designed before the introduction of modern crashworthiness standards in 1994.

(paragraphs 617c, 617f)

- 20 *The intent of this recommendation is to reduce the risk from train fires originating in or around batteries fitted to passenger vehicles, recognising the trend towards increased use of battery systems to store energy for motive power. To address this recommendation, it is envisaged that RSSB will investigate the fire-related properties of products used in other transport sectors.*

RSSB should investigate alternative designs of batteries, and their casings, which may offer improved fire-related properties compared to those currently fitted to rolling stock. The output from this investigation should be shared with the UK train and tram industry (paragraph 617h).

## Learning point

639 RAIB has identified the following important learning point:<sup>79</sup>

- 1 Railway staff are reminded that, if available and they are trained to use it, GSM-R radio is normally the most appropriate way to communicate urgent safety information to signallers (paragraph 618b).

---

<sup>79</sup> 'Learning points' are intended to disseminate safety learning that is not covered by a recommendation. They are included in a report when RAIB wishes to reinforce the importance of compliance with existing safety arrangements (where RAIB has not identified management issues that justify a recommendation) and the consequences of failing to do so. They also record good practice and actions already taken by industry bodies that may have a wider application.

This page is intentionally left blank

# Appendices

## Appendices

### Appendix A - Glossary of abbreviations and acronyms

A&EWP	Adverse and extreme weather plan
CCTV	Closed-circuit television
CCQ	Colour coded quality – coloured chart showing track quality
CDM	Construction (Design and Management)
CEFA	Civils Examinations Framework Agreement
CIRIA	Construction Industry Research and Information Association
CP	Catchpit
CRT	Critical rail temperature
DOM	Duty operations manager
DPE	Designated project engineer
ECN5	East Coast (Northern) – reference for part of the railway network
EWAT	Extreme weather action teleconference or Extreme weather action team
FEH	Flood estimation handbook
FTN	Fixed telecom network
FWI	Fatalities and weighted injuries
GNER	Great North Eastern Railway
GRP	Glass fibre reinforced plastic
GSM-R	Global System for Mobile Communications – Railway
HSMS	Health and safety management system
HST	High speed train
HVAC	Heating, ventilation and air conditioning
IDP	Integrated drainage project
IWMP	Integrated weather management plans
LNW	London North Western
LOM	Local operations manager
MOM	Mobile operations manager

NOP	National operating procedure
NRG	National Records Group
NRRP	National Recommendations Review Panel
NRWS	Network Rail Weather Service
NW&C	North West and Central
ORR	Office of Rail and Road
OTDR	On-train data recorder
PCLS	Principal contractor licensing scheme
PIM	Precursor indicator model
P/Way	Permanent way (track)
RAIB	Rail Accident Investigation Branch
RAM	Route asset manager
RCM	Route control manager
REC	Railway emergency group call
RSSB	Trading name of Rail Safety and Standards Board
SCHI	Soil cutting hazard index
SEPA	Scottish Environment Protection Agency
SHE	Safety, Health and Environment
SHEP	Safety, Health and Environment Performance
SRM	Safety Risk Model
TQ	Technical query

## Appendix B - Glossary of terms

All definitions marked with an asterisk, thus (\*), have been taken from Ellis's British Railway Engineering Encyclopaedia © Iain Ellis. [www.iainellis.com](http://www.iainellis.com).

Absolute block	A form of signalling that only allows one train on each track between each signal box.
Abutment	The ends of a bridge. For a masonry arch bridge, the abutments resist the lateral force of the arch.
Angle of attack	The angle between the running edge of the rail and the plane of the wheel flange.*
Block bell	A single stroke electromechanical bell used for communication between control points.*
Block instrument	Device used for obtaining permission for trains to proceed from one signal box to the next.
Buckling	Sudden, severe and short bending in the track caused by a lack of lateral stability, poor maintenance and (generally) high rail temperatures.*
Cant (crosslevel)	The measured difference in level between the two running rails of a track at a particular location.*
Carrier drain	A drain intended to carry water from one point to another. The pipes are un-perforated, and not intended to collect water along their length.*
Catchpit	Chamber to allow maintenance inspection and access.
Cess	The part of the track bed outside the ballast shoulder that should be maintained lower than the sleeper bottom to aid drainage.*
Chain (as a distance measurement)	Equal to 22 yards or approximately 20 metres. One mile equals 80 chains.
Colour-light signals	A signal or signals which convey movement authorities to train drivers by means of coloured lights.*
Conductor	A member of train staff with roles including ticketing duties and passenger assistance.
Conductor rail	An additional rail, used to convey and enable collection of electrical traction current at track level.*
Containment kerb	A robust structure extending at least 300 mm above rail level running parallel to and outside the running rails for the purpose of preventing excessive lateral deviation of a derailed train.



Convective rainfall/storm	Convective storms are severe local storms associated with thunder, lightning, heavy rain, hail, strong winds and sudden changes in temperature. They can occur all year round but are most common during the summer months.
Coping (stone)	The finishing or protective (stone) that forms the top of an exterior masonry wall.*
Crossover	Two turnouts or single leads connected to permit movements between adjacent tracks.*
Diesel-electric	A traction unit that utilises a diesel engine to drive an electrical generator. This current is then used to power electric traction motors.*
Diesel multiple unit	A multiple unit train whose source of power is a diesel engine.*
Facing point lock	A device which secures points in position and is required on points while passenger trains are passing over them in the diverging, or facing, direction.
Filter drain	A trench filled with gravel and sometimes, as at Carmont, containing a perforated pipe.
Flange climb	A situation where the flange of a rail wheel rides up the inside (gauge) face of the railhead while rotating.
Four-foot	The area between the two running rails of a standard gauge railway.*
Guard rail	Rails provided either between the running rails or on the sleeper ends to limit lateral movement of vehicles wheels after a derailment.
Geotextile	A permeable fabric with uses including, as at Carmont, preventing the passage of soil particles while allowing the passage of water.
Global System for Mobile Communications – Railway	The radio system used on the national rail network for purposes including communication between train drivers and signallers.
Knee bolster	A form of secondary impact protection comprising a pad of energy-absorbing material fitted to the console of the driving cab where a driver’s knee would be expected to impact in the event of a collision.
Local operations manager	An individual who manages the day to day operation of a given area of Network Rail controlled infrastructure.*
LiDAR	Light detection and ranging. A form of survey using reflections of a pulsed laser beam emitted from airborne or ground based survey equipment.

Mobile operations manager	A member of Network Rail staff who provides first-line response to incidents that affect the operation of the railway.
Monocoque structure	An integrated stressed-skin structure in which the whole structure, including skins panels and roof, works together to carry the required loads (unlike older designs of railway vehicles which relied on a stiff chassis or underframe to carry the loads).
On-train data recorder	A data recorder collecting information about the performance of a train typically including: speed, regulator and brake control positions, activations of the horn etc.
Overland flow	Surface runoff of rainwater.
Overline bridge	A bridge spanning over the railway.
Parapet	A low wall along the side of a bridge.
Pitching (of a vehicle)	Rocking motion of a vehicle, back and forth parallel to the direction of travel.
Points	An assembly of switches and crossings designed to divert trains from one line to another.*
Possession	The closure of specific sections of track to enable engineering work to take place.*
Railhead	The bulbous upper part of a rail section.*
Return period	The likelihood of an event. A 50 year return period means a 1 in 50 likelihood of the event occurring in any particular year.
Route control	The Network Rail organisation in each Route responsible for monitoring the operation of the railway and coordinating any action required when out-of-course events occur.*
Scotches	Wedge-shaped pieces of timber placed between a switch rail and a stock rail to ensure an open switch remains so.*
Scour	Erosion by water, including undermining of bridge foundations by high river flows.
Sediment flow	A mixture of water and sediment particles including grains of silt, sand, gravel, cobbles and boulders.
Semaphore signals	Mechanical signals generally consisting of moveable arms.*
Sled test	A means of reproducing the dynamic conditions of a collision event. Parts to be tested (for example, driver's seat, console, windscreen) and a test dummy, are fitted to a sled which is subjected to accelerations simulating a collision.
Topography	Shape of the ground surface.

Train Protection and Warning System	An automatic trackside and on-train system which enforces limits on the speeds of trains so as to reduce the frequency of collisions and overspeeding at critical locations.*
Train reporting number	An alphanumeric code allocated to every train operating on Network Rail's infrastructure.
Tread corner mark	A witness mark left by the outer edge of the tread of a rail wheel (tread corner).
Underline bridge	A bridge supporting the railway.
Voiding	Space (if any) between underside of sleepers and underlying ballast.
Wingwalls	Side walls of an abutment.
Yaw	The rotation of a bogie about the vertical axis.

## Appendix C - Investigation details

### *Appendix C.1 Sources of evidence used in this investigation:*

- aerial photography
- Carmont project construction records
- closed-circuit television (CCTV) recordings taken from trains
- drainage design review report commissioned by RAIB from AECOM Ltd
- ground investigation including both on-site and laboratory testing of soil and rock
- information taken from the train's on-train data recorders (OTDR)
- information provided by witnesses
- LiDAR (ground topography) surveys
- railway industry records and documents
- signalling and railway operations data
- site photographs and measurements
- telephone voice recordings
- weather reports and observations at the site and surrounding area
- a review of previous RAIB investigations that had relevance to this accident.

### **Appendix C.2 Organisations assisting RAIB**

In addition to the organisations listed in paragraphs 10 to 17, RAIB acknowledges with thanks the assistance provided by the following:

- Abbott Toxicology Ltd
- AECOM Ltd
- British Transport Police
- Dunelm Geotechnical & Environmental Ltd
- Emeritus Prof W Angus Wallace & Professor Ben Ollivere, University of Nottingham, Queen's Medical Centre
- Forbes-Laird Arboricultural Consultancy (FLAC)
- Forensic Healthcare Services Ltd
- Independent Glass
- Optima Health
- Police Scotland
- Principal Forensic Services Ltd
- Raeburn Drilling & Geotechnical Ltd / Terra Tek
- RAF Medical Services
- RSSB
- Socotec UK
- Surescreen Scientifics Ltd
- The Railways Archive
- Unipart Rail
- University of Edinburgh, School of Engineering.

## Appendix D – Weather-related disruption in Scotland on 11/12 August 2020

Known infrastructure failures at 06:55 hrs on 12 August 2020 – refer to figure 14

	<i>Time of initial report</i>	<i>Location</i>	<i>Nature of failure</i>
1	15:58 hrs, 11 August	Hilton Junction to Blackford	Axle counter failure, caused by lightning strike
2	16:55 hrs, 11 August	Blair Atholl	Various failures of signalling equipment caused by lightning strikes
3	19:56 hrs, 11 August	Newtongrange	Flooding of track
4	22:26 hrs, 11 August	Kinghorn tunnel	Track circuit failure due to flooding
	00:00 hrs, 12 August	Kinghorn to Kirkcaldy	Landslip affecting safety of the line
	01:26 hrs, 12 August	Burntisland to Kinghorn	Landslip affecting safety of the line
5	23:07 hrs, 11 August	Edinburgh Waverley	Fire alarm activation caused by water ingress
6	23:16 hrs, 11 August	Edinburgh - Mound Tunnel	Flooding of track
7	23:28 hrs, 11 August	Pye Road Crossing (near Perth)	Level crossing failed due to lightning strike
8	23:32 hrs, 11 August	Craightinny depot (Edinburgh)	Overhead line trips due to lightning strikes
9	00:50 hrs, 12 August	Cowdenbeath	Track circuit failure due to flooding
10	00:52 hrs, 12 August	Edinburgh – Suburban line	Track circuit failures due to flooding
11	00:54 hrs, 12 August	Niddrie West Junction	Track circuit failure due to flooding
12	00:54 hrs, 12 August	Craiglockhart Junction	Track circuit failure due to flooding
13	00:54 hrs, 12 August	Armadale	Track circuit failure due to flooding
14	00:54 hrs, 12 August	Lochgelly	Track circuit failure due to flooding
15	00:54 hrs, 12 August	Ladybank Junction to Hilton Junction	Axle counter failures due to flooding
16	01:16 hrs, 12 August	Niddrie Junction to Craiglockhart Junction	Garden wall collapsed onto railway and ballast washed away
17	01:26 hrs, 12 August	Aberdour	Two landslips affecting safety of the line
18	01:49 hrs, 12 August	Craiglockhart Junction	Flooding of track
19	02:08 hrs, 12 August	Redford Junction	Flooding of track
20	02:41 hrs, 12 August	Perth	Multiple track circuit failures and flooding

	<b><i>Time of initial report</i></b>	<b><i>Location</i></b>	<b><i>Nature of failure</i></b>
21	03:11 hrs (approx.), 12 August	West of Scotland Control Centre, Cowlairs, Glasgow	Telecommunications equipment failures affecting Control, meaning back-up mobile phones having to be used for some calls
22	03:20 hrs, 12 August	Shotts	Three landslips affecting safety of the line and track circuit failure due to flooding
23	03:29 hrs, 12 August	Forteviot Level Crossing	Axle counter failures and flooding
24	03:38 hrs, 12 August	Hartwood station	Track circuit failure due to flooding
25	04:25 hrs. 12 August	Carfin station	Track circuit failures, suspect flooding
26	04:53 hrs, 12 August	Stirling to Dunblane	Overhead line issues
27	05:30 hrs, 12 August	Clunybridge	Landslip affecting track support and safety of the line
28	05:46 hrs, 12 August	Polmont	Canal breach affecting track support and safety of the line. Multiple infrastructure failures
29	06:48 hrs, 12 August	Caldercruix to Blackridge	Flooding
30	06:53 hrs, 12 August	Auchterarder to Hilton Junction	Landslip affecting track support and safety of the line

## Appendix E - Accident sequence

The following likely sequence of events was constructed using information from the sources below. Times are from derailment at the washout and are indicative.

- track inspection records and photos
- derailment marks
- site surveys and photos
- damage to the bridge
- ground marks
- aerial photos and videos
- wood samples from the leading coupler of coach C
- detailed inspection of vehicle damage at Springburn depot
- OTDR data.

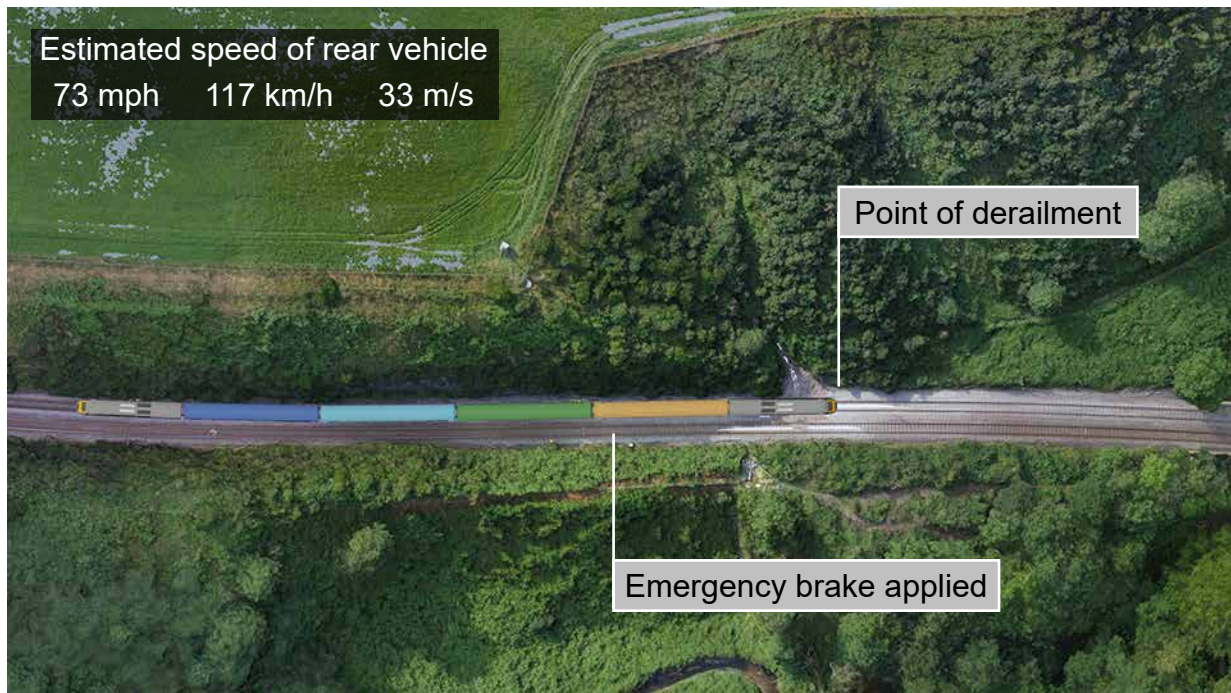

Figure E.1 ( $T= 0$  seconds):

- Leading power car's leading bogie derails to the cess immediately after running over washout debris, followed by trailing bogie.



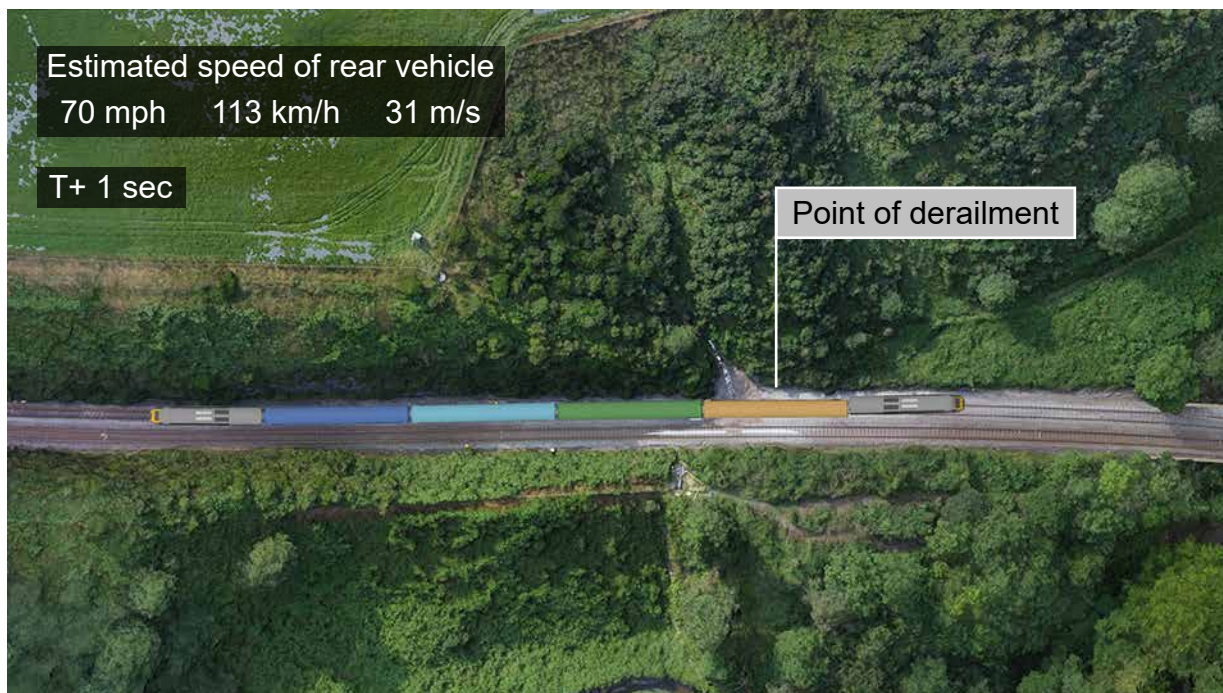

Figure E.2 (T+1 second):

- Leading power car's derailed leading bogie deviates further to the left.
- Derailed trailing bogie is restrained by coach D.



Figure E.3 (T+2 seconds):

- Leading bogie of the power car deviates further to the left and towards parapet, image (a).
- Trailing bogie is running derailed but still restrained by coach D.
- Inset image (b) shows position of leading wheelset (depicted by wheelset template) at sleeper 75 (around 53 metres from the washout).



Figure E.4 (T+3 seconds):

- Leading power car strikes and demolishes left-hand bridge parapet, image (a).
- Sudden compressive force at the first interface and height difference between coach D (high) and power car (low) causes coach D to override the trailing right-hand side of the power car.
- Damage to leading bogie from impact with parapet, image (b).
- Damage to leading coupler of coach D - coupler bent downwards, image (c).



Figure E.5 (T+4 seconds):

- Overriding continues between leading power car and coach D, image (a).
- Rear of power car no longer restrained by coach D, image (b).
- Coach D lifts off from its leading bogie during overriding, which allows further interpenetration between the vehicles, image (c).
- Power car veers off the bridge.



*Figure E.6 (T+5 seconds):*

- Leading power car starts to fall off the bridge.
- Leading end of coach D is pulled to the left during the override.
- Detached leading bogie from coach D follows power car off the bridge.
- Leading end of coach D, having lost its bogie, slides forward on its underframe equipment bay without its centre pivot digging into the ballast.



Figure E.7 (T+6 seconds):

- Leading power car impacts the embankment below the bridge, image (a).
- Leading end of coach D pitches down the embankment on the left, causing it to lift off its trailing bogie and slide on its underframe equipment.
- Lifting at the trailing end of coach D causes coach C to lift off its leading bogie.
- Jack-knifing develops at the interface between coaches C and D resulting in corner contact damage to coach C, image (b) and coach D, image (c).
- Jack-knifing pushes leading end of coach C to the right and into collision with the up-side bridge parapet.

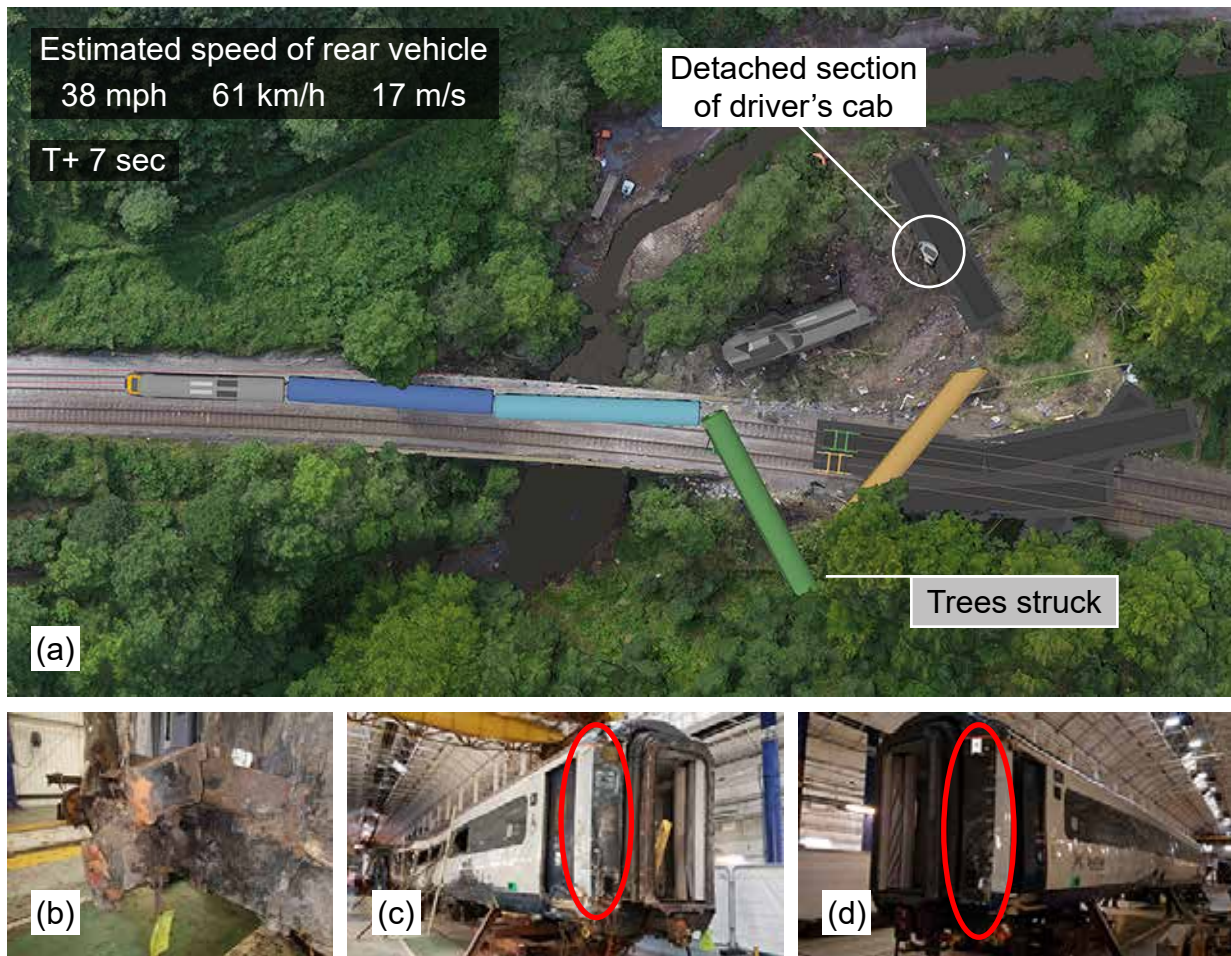

Figure E.8 (T+7 seconds):

- Driver's cab detaches and moves down the embankment slope, image (a).
- Coach C runs through trees while pitching down and impacts the earth bank on the up cress. Wood from trees in the up cress was found in the leading coupler of coach C, image (b), confirming its path.
- One passenger is ejected through the leading gangway of coach C.
- Jack-knifing occurs between coach C and coach B resulting in corner contact damage to coach B, image (c) and coach C, image (d).
- Coach D slides forward on its underframe, maintaining its rotated position.



Figure E.9 (T+8 seconds):

- Coach C pivots about the earth bank in the up cess and is rotated round in a clockwise direction by coach B pushing it from behind.
- As coach C rotates, its trailing end pitches up, pushing the leading end of coach B off the track and lifting coach B off its leading bogie.
- Coach B starts to veer to the left and down the embankment.



Figure E.10 (T+9 seconds):

- Driver's cab comes to rest at the bottom of the embankment.
- Coach B veers down the embankment, and rotates anticlockwise, being pushed from behind by coach A, and lifts off its trailing bogie.
- Coach C is still rotating clockwise under its own angular momentum.

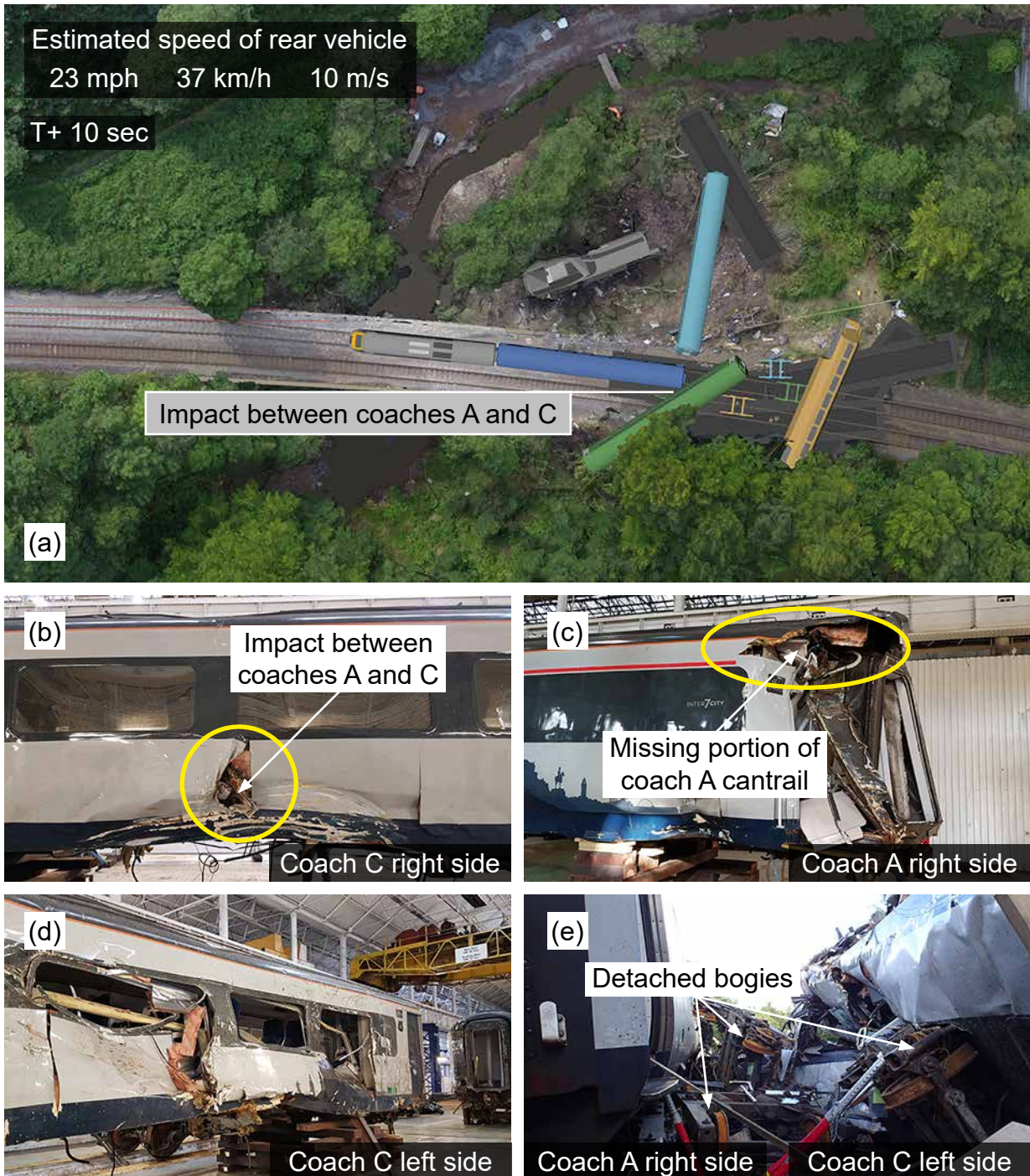

Figure E.11 (T+10 seconds):

- Coach A collides with coach C, penetrating coach C's bodyside, images (a) and (b) with a portion of its right-hand cantrail, image (c).
- Coach C is driven round clockwise by the impact with coach A and strikes detached bogies in its path, image (e). The trailing left-hand side suffers penetration damage, image (d).
- Meanwhile coach B continues to move towards its final rest position.
- Coach D is at a temporary rest position on its right side.





*Figure E.12 (T+11 seconds):*

- Coach A collides with detached bogies in its path and its leading end is lifted up off the leading bogie.
- Coach D is pushed further along the track by coach A and this contact starts to roll coach D over.
- Coach B continues to slip down the embankment.
- Coach C rotates further clockwise and is lifted and rolled by detached bogies onto the top of the trailing end of coach D.



Figure E.13 (T+12 seconds):

- Coach A climbs over coach D, rolling it further onto its roof.
- Coach C rolls over onto its roof and moves to its final rest position on top of the trailing end of coach D.
- Coach B starts to roll over as its leading end approaches the bottom of the embankment.



Figure E.14 (T+13 seconds):

- Coach A continues to climb over coach D.
- Coach B rolls over into its final rest position.



Figure E.15 (T+15 seconds and end of sequence):

- Rear power car has travelled approximately 240 metres during the accident.

## Appendix F - Track and bridge 325 - condition and damage

### Context

F1 This appendix sets out the evidence from which RAIB has concluded that neither the condition of the track, nor the condition of bridge 325, were a cause of the accident.

### Track

F2 The down line, on which train 1T08 was travelling, falls at an average gradient of 1 in 105 (0.95%) between the location where the derailment occurred and the south end of bridge 325.

F3 The derailment occurred shortly after the track alignment changes from a left-hand curve to a right-hand curve in the direction of travel on the down line. The start of the right-hand curve is located about 30 metres before the start of the washout debris and 40 metres before the first derailment mark (designated sleeper 0). Due to the curve, there was a level difference (cant) between the rails at the point of derailment, with the left-hand rail of the down line being 50 mm higher than the right-hand rail. As the curve became progressively tighter, the *cant* increased to 120 mm at the south end of bridge 325 and reached a maximum of 130 mm just beyond milepost 221 near the north end of the bridge.

F4 The down line track was constructed of continuous welded, flat-bottom BS113A/56E1 rail, with sections dating from between 1970 and 2019, laid on concrete sleepers at an average spacing of 0.71 metres. The track was last renewed between 1966 and 1970. Before the accident, rail stressing records held by Network Rail indicated that the down line left-hand (cess) rail had a stress-free temperature of 27°C and the down line right-hand (six-foot) rail had a stress-free temperature of 21°C. Rail stressing is undertaken to reduce the risk of the track buckling in very hot weather. At the time of the accident, the air temperature recorded at Inverbervie, 13.7 km (8.5 miles) from the accident site, was approximately 19°C. Given the time of day, the rail temperature would have been about the same as the air temperature, and so it would not cause buckling (deformation) of the rail.

F5 Rail alignment has been measured periodically for many years by equipment mounted on track recording trains. A track quality graph (CCQ graph) covering the 220 yard (201 metre) section of track approaching bridge 325, including the location of the derailment, indicates that this section of track was stable. The CCQ graph, starting in 1994 and showing several data points each year, records top and line of the track (the vertical and horizontal alignment of the rails) remaining in the 'good' category with only a slow deterioration over time. Post-accident testing identified no significant *voiding* beneath the sleepers on the approach to the washout. Network Rail's maintenance records indicate that the last mechanised maintenance was undertaken during two shifts in 2014 using stone-blower equipment. This resulted in improvements in track geometry which are visible on the graph.

- F6 On 21 July 2020, a track recording train equipped with an optical system for measuring the ballast profile, in addition to equipment for measuring rail alignment, ran on the down line through the area where the derailment occurred. Recorded data did not identify any defects with the track, track geometry or ballast profile. Forward-facing CCTV images from this train show that a ballast shoulder was present on the left-hand side of the track providing support and restraint to the sleeper ends.
- F7 The section of track where the derailment occurred was last inspected during the night before the accident when a basic visual inspection was undertaken. This was focused on the track and ballast and was undertaken by an infrastructure technician and a driver travelling slowly in a road-rail vehicle fitted with additional lighting to facilitate inspections. The inspection started from Carmont level crossing at about 02:00 hrs on 12 August and proceeded towards Stonehaven. Approximately 150 metres before the derailment site, the technician fitted rail clamps to the six-foot rail. This was a scheduled repair to a previously reported rail weld defect. The weather during the inspection was dry and slightly overcast. The inspection report stated that 'no actionable defects' were found for the section of track where the accident later occurred.
- F8 The preceding visual inspection, undertaken on 14/15 July 2020, also found no actionable defects but recorded that a short section of rail had been placed at the side of the down line in the area where the washout subsequently occurred. The presence of this section of rail may have acted as a barrier and slightly reduced the volume of debris on the track, but played no other part in the accident. Earlier inspections on 16/17 June and 19/20 May 2020 also found no defects requiring action in the area where the derailment occurred.
- F9 A track supervisor's visual inspection in March 2020 reported a 30-foot length of scrap rail in the cess next to the down line at the washout location and recorded that it should be removed within three months. This section of rail was still present on 20 August 2020 (figure 19) but it had no relevance to the derailment.

#### Summary of track damage

- F10 The first identified derailment mark was a tread corner mark made by the edge of a right-hand wheel on the right rail close to the northern limit of the debris coverage. This was designated as the point of derailment, and denoted sleeper 0. The RAIB investigation has established that the mark was almost certainly from the leading wheelset of the leading power car as it derailed to the left (paragraph 75).
- F11 A detailed inspection covering approximately 250 metres of the down line immediately before the washout found no evidence of derailment marks or track damage. Debris from the washout was present from 13 sleepers (9 metres) before sleeper 0 and continued for about 1 metre beyond it.
- F12 The observations from detailed inspections of the track from the point of derailment onwards are listed in table F1.

Sleeper number	Distance from sleeper 0 (m)	Description
0	0	First wheel marks on head of rail
1	1	Northern limit of washout debris
5	3.4	Start of marks on clips (due to derailed wheels)
11	7.6	Start of broken sleepers on cess side of left rail
14	9.8	Start of significant damage to sleepers and fastenings to the left of the right rail
35	24.5	Extensive scuffing on left-hand (cess) railhead associated with underframe equipment dragging
40	28	Damage in middle of sleepers. Right-hand wheel of wheelset 1 in centre of track
62	43.5	Right-hand wheels running against right-hand side of the left-hand (cess) rail
71	49.8	Sleepers destroyed
79	55.5	Right-hand wheel of wheelset 1 crosses left-hand (cess) rail
88	61.8	Start of bridge parapet
93	65.3	Right-hand ('six-foot') rail rotated

Table F1: Schedule of track damage

F13 From around sleeper 40, the ridge of ballast (ballast shoulder) on the left-hand side of the track was displaced in a manner consistent with the ploughing action of the derailed bogie, leaving sleeper ends partly exposed on the approach to the bridge (figure F.1 and figure 24c).

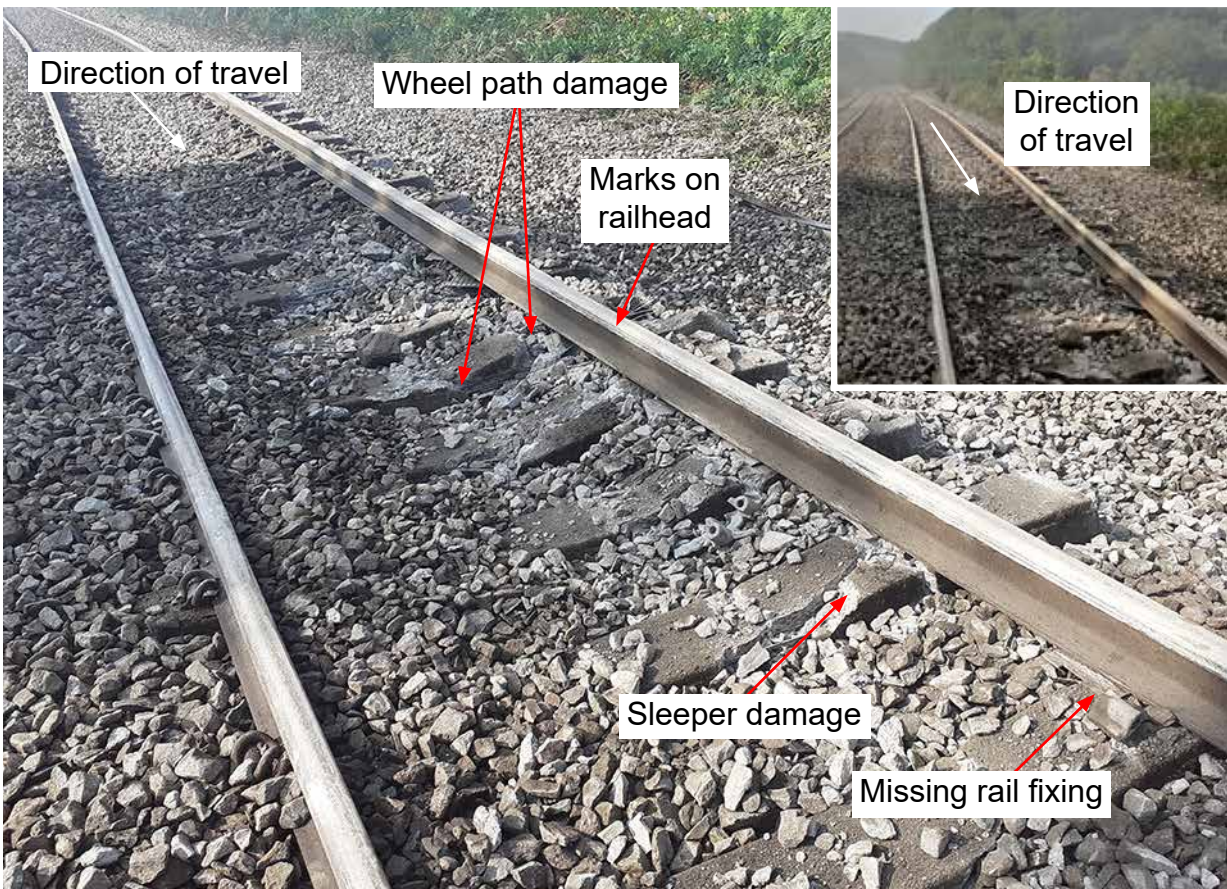

Figure F.1: Track damage looking south from sleeper 80 back towards washout location at 10:35 hrs on 12 August 2020 (Story Contracting)

- F14 The significant lateral kink in the down line around sleeper 85 is consistent with the movement expected due to wheels pushing against the gauge face (right-hand) edge of the left-hand rail. Marks starting at sleeper 62 provide evidence that the back faces of the right-hand wheels of the leading bogie were in contact with the gauge face of the left-hand rail until the wheels were lifted over this rail between sleepers 79 and 85. The lateral track movement is also evident from marks in the ballast at the right-hand end of sleepers approaching the south end of the bridge.
- F15 Across bridge 325, further track distortion occurred as the trailing bogie of the leading power car crossed the left-hand rail and veered off the bridge. The right-hand rail was rolled over to the right, probably as a result of being struck and loosened by the jack-knifing between coach D and C and then being flattened by the trailing power car (figure F.2).



Figure F.2: Track damage across bridge 325 at 10:35 hrs on 12 August 2020 (Story Contracting)

- F16 Cables running in pre-cast concrete troughing adjacent to the down line formed part of Network Rail's fixed telecom network (FTN). The cable route was buried by the washout debris but was not damaged and continued to operate until being severed at the bridge during the derailment.

### Bridge 325

- F17 Bridge ECN5 133/325 (bridge 325) is located at 220 miles 1712 yards and carries the two-track railway 12 metres above Carron Water. The bridge has a 9.1 metre wide single-span masonry arch with parallel *wingwalls* (figure F.7). The arch rises by 3 metres and provides 9.8 metres clearance above average water level.

- F18 There are no construction drawings available for this structure, but drawings are available for nearby bridges 326 and 328 which were built at about the same time and are of a similar design. These indicate that the arch is of ribbed construction supported by *abutments* faced by wingwalls. Masonry deck slabs span from the external wingwall to internal walls rising from the arch and from ground level between the wingwalls. This creates some voids within the structure.
- F19 Masonry parapets were constructed along the top of the wingwalls and arch. The parapets incorporate a course of stone blocks which project outwards for decorative purposes (a string course) and were originally built with a reduced-height section above the arch on both sides of the bridge. Photographs indicate that the reduced-height sections of parapet were fitted with railings as parapet edge protection.
- F20 British Rail issued a structural assessment report for bridge 325 in December 1980. Photographs included in this report show that the reduced height sections of parapet had, by then, been infilled with concrete blocks to make each parapet a uniform height. Infilling the gaps allowed the ballast depth to be increased and a cross-section drawing within the report shows the top of the ballast at the same level as the underside of the coping (uppermost) stones on the down-side parapet (figure F.3). The ballast remained at about this level until the accident. A post and wire fence was installed as parapet edge protection for staff working on the railway.

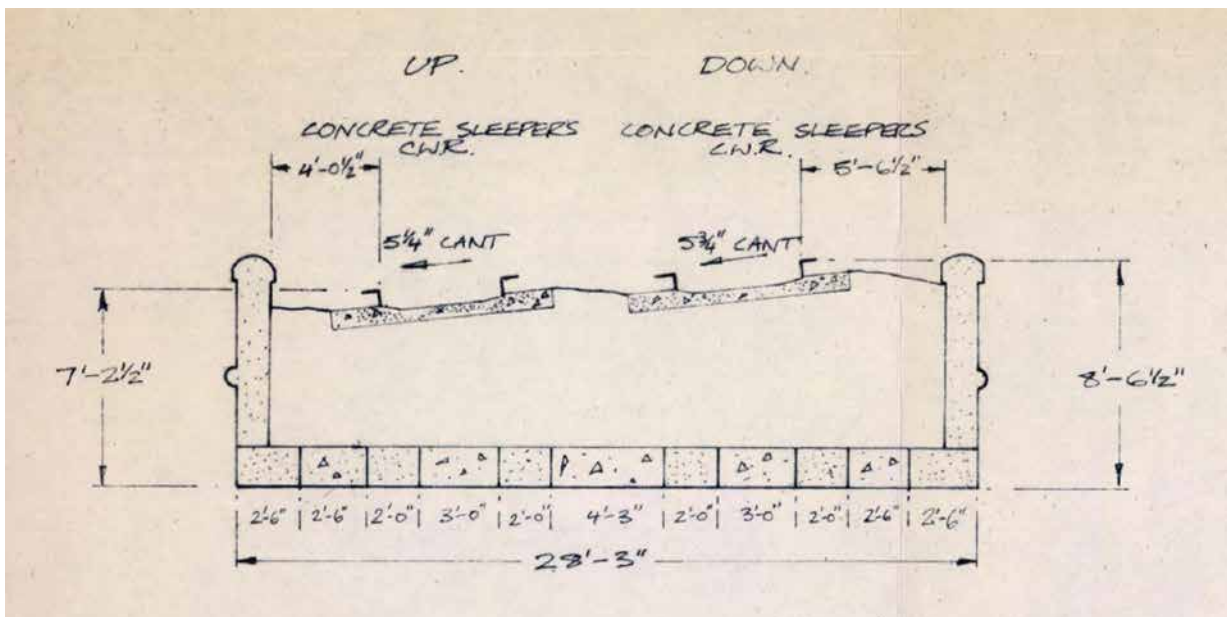

Figure F.3: Drawing showing level of the tracks relative to the parapets (1980)

- F21 The assessment report did not include any comment about the ballast level. However, it found that the arch ribs were damp. The bridge does not have a track drainage system, so rainwater filters between the deck slabs and into the ground. Cast iron drainage pipes pass through the spandrel (side) walls on each side of the bridge just below string course level, to drain water from behind the parapet wall.



- F22 Amey had held Network Rail's Civils Examinations Framework Agreement (CEFA) contract for structures examinations in Scotland since 2009. It was responsible for undertaking planned visual and detailed examinations, and for undertaking rapid response (post-incident) examinations when required.
- F23 The most recent detailed examination of bridge 325 was undertaken in November 2014. The examination report recorded a parapet height of 100 mm from top of ballast level adjacent to the down line and 300 mm adjacent to the up line. The report identified some deterioration to the masonry and noted that the low mileage abutment had 'wet and damp patches throughout'. It recorded that the down-side parapet was in fair condition. Longitudinal fractures were identified on both sides of the arch where it met the spandrel walls. The examination report indicated that there were no previously unreported defects.
- F24 The depth of the ballast present before the accident meant that it applied an outward force on almost the full height of the down-side parapet wall and for a large proportion of the up-side parapet wall. It is possible this force contributed to the formation of longitudinal fractures between the arch and the spandrel walls (figure F.4). There is no evidence that these fractures influenced the behaviour of the parapets during the accident.



Figure F.4: Down-side elevation of bridge 325 at 08:19 hrs on 12 August 2020, shortly before the accident (Story Contracting)

F25 The most recent visual inspection of the bridge took place in June 2020. The report found no new structural defects or significant deterioration to existing defects. It identified displaced stonework along the riverbank adjacent to the bridge and the need for riverbank repairs.

#### Summary of damage to bridge 325

F26 On 17 August 2020, an Amey structures examiner undertook an examination of bridge 325 to assess the damage caused during the accident.

F27 The Amey report noted the following:

##### Down-side parapet:

- The section of parapet over the low mileage (south end) wingwall had three areas of deep mechanical spalling to the exposed top two courses up to 220 mm deep. The adjacent stonework remained stable. (RAIB site measurements indicate that parapet damage at the south end of the down-side parapet extended for about 6 metres, figure F.5).
- The parapet had its coping stones pushed off for the full length with the exception of five coping stones over the high mileage wingwall (north end). These had been displaced by up to 100 mm but remained stable (figure F.6).
- There was a large damaged (spalled) section of masonry directly above the crown (centre) of the arch (figure F.7).
- Otherwise the down-side parapet stonework remained intact and stable.

##### Up-side parapet:

- The section of up-side parapet above the high mileage (north end) wingwall had been knocked down to the string course. (RAIB site measurements indicated that parapet damage at the north end of the up-side parapet extended for about 9 metres, figure F.8).
- Otherwise, the up-side parapet stonework remained intact and stable.

##### Soffit (arch):

- Long-standing longitudinal fractures along the back of the stone blocks forming the arch ring (voussoir blocks) had widened. The Amey report stated: '*The old-standing longitudinal fracture along the back of the down side voussoirs shows slight deterioration now open 8mm (previously 5mm). The old-standing longitudinal fracture behind the back of the Upside brick face rings shows significant deterioration and is now almost full span and open up to 10mm in places (previously 5mm).*'

#### Post-accident repairs

F28 Following the accident, and in preparation for the reopening of the line in October 2020, Network Rail undertook both repairs and additional works to address pre-accident problems and to improve the general condition of the structure. These were described by Network Rail as:

- The remainder of the down-side parapet was taken down to a uniform level and new precast concrete parapet units were installed over the full length of the structure, dowelled into competent material in the remaining spandrel wall. Handrail extensions of approximately 700 mm in height were added to provide edge protection for people on the bridge (figure F.9).



Figure F.5: Down-side parapet looking north showing damage to the parapet end



Figure F.6: Down-side parapet looking south showing remaining coping stones (Amey)



Figure F.7: Down-side elevation of bridge 325 on 14 August 2020



Figure F.8: Up-side parapet damage (a) looking south and (b) looking north

- The damaged section of the up-side parapet at the high mileage end of the structure, over approximately 6 m length, was taken down to sound material and rebuilt like-for-like in new masonry. This required a new handrail which was continued for the full length of the up-side parapet.
- Approximately 3 m of ballast retention wall was installed on the up-side and down-side at both ends of the structure. This comprised driven steel posts with infill precast concrete panels and handrails.
- Grouted stitching bars were installed to each stone (voussoir) in the arch ring embedded 2 metres into the arch barrel on both the up-side and down-side. Network Rail has confirmed that these works addressed existing defects within the structure (longitudinal separation fracture between spandrel (voussoir) and barrel), and were considered integral to reinstating the full integrity of the structure due to the potential impact damage suffered during the accident.
- Grouting of a vertical hairline fracture to the high mileage (north) abutment.



Figure F.9: Bridge 325 in April 2021 following the replacement of the down-side parapet and track

### Scour protection works

F29 At the base of bridge 325, scour protection works were in progress at the time of the accident to prevent the river eroding away the bridge foundations. The northern abutment had been identified as vulnerable during a scour assessment undertaken on behalf of Network Rail in September 2016. Scour risk meant that the structure was monitored when river levels were high, but this was not the situation on the morning of 12 August 2020.

- F30 In its planning application to Aberdeenshire Council submitted in June 2019, Network Rail described the works as ‘to construct a reinforced concrete invert within the channel near the bridge to provide a high level of scour protection with minimal excavation, mitigating the risk of undermining the bridge’s shallow abutment.’ Story Contracting was awarded the contract to install scour protection to both bridge 325 and bridge 328 located approximately 1.8 km (1.1 miles) further north.
- F31 Work at bridge 325 commenced on 20 July 2020, and the concrete forming the main base slab across the river bed was poured on 11 August 2020 (figure F.10). During these works, the river flow was controlled by a temporary dam and diverted through a pipe. There is no evidence suggesting that scour or the works being undertaken to address scour risk were factors in the accident.



*Figure F.10: Scour protection works at bridge 325 on 11 August 2020 (Story Contracting)*

## Appendix G - Historical and land drainage

### Historical crest and funnel feature drain

- G1 The drainage arrangements along the railway boundary before the cutting stabilisation and drainage works commenced in 2011 are shown schematically on figure 32. This diagram is considered the most likely arrangement based on surveys undertaken for these works, post-accident investigations and professional judgement.
- G2 The pre-2010 crest drain, comprising 9-inch (225 mm) diameter clay pipes, ran north along the cutting crest from a high point near the future position of CP10 to near the proposed position of CP16 where it sloped steeply downwards to an outlet in the top of a short channel, near the as-designed position of CP18 (figure 48). Throughout this length, the drain ran just inside the railway boundary and along, or just downslope of, the cutting crest (figures G.1 and G.2). Unlike the drain installed by Carillion, the old drain had a low point between CP10 and CP16, at approximately 220 miles 1420 yards (180 metres from CP10 and 126 metres from CP16), near a rectangular access chamber formed of pre-cast concrete rings about 1.5 metres deep. The old drain was not connected to the burn which fed into the north end of the 2011/12 drain. Until this drain was constructed, flows from this burn were carried southward in an open channel.
- G3 Although the 2011/12 drain was provided because the old one was not functioning satisfactorily, the old drain was not removed (and Arup drawings did not require it to be removed) as part of the 2011/2012 works except for a very short length at the downstream end where the old pipe ran across the excavation required for the 2011/12 drain (figure G.2).
- G4 Observations after the accident showed that the old drain still collected and discharged water, although the way it did this would have been influenced by post-accident investigations, such as those which exposed the lower end of the pipe. There is no evidence that the old drain discharged water in a manner which influenced the accident. A broken section of pipe was found on the ridge separating the funnel feature and the new drain from the railway. Although the break was positioned near the top of the area from which gravel was washed from the 2011/12 drain, and was likely to have been present before the accident, there were no witness marks (such as soil erosion) indicating a significant outflow of water from the pipe at this location (figure G.3).
- G5 The pre-2010 ditch and the pipe leading from this to an outlet in the channel adjacent to the historical crest drain outlet, and their potential effects on the accident, are described at paragraph 95 and paragraph 138.
- G6 The pre-2010 channel started near the as-designed position of CP18 and carried water away from the boundary fence into another pipe which took it to a catchpit on the track drainage system from which it was piped to an outfall at the beginning of a ditch leading towards Carron Water. The channel and the upper part of the pipe leading from this to the track drainage system were removed during the 2011/12 drain construction work, probably in 2011 (paragraph 137).

- G7 Arup drawings show CP18 at approximately the position where the historical crest drain and the pipe from the pre-2010 ditch meet at the top of the channel. Arup drawing 002/004 refers to two existing pipes (by inference, these pipes) being connected to CP18. Post-accident investigation showed that neither of these connections were made.
- G8 The track drainage system, including the associated catchpit, remained in use after construction of the 2011/12 drain. Post-accident investigation of this catchpit, supervised by ORR, found the connection from an old pipe (likely to be that from the pre-2010 channel).

#### Land drainage

- G9 Post-accident investigations undertaken by Network Rail in the field adjacent to the funnel feature revealed a network of field drains laid a short distance below the ground surface (figure G.4). Some comprised large stones placed in a trench and then covered with soil (probably the oldest drains), some consisted of clay pipes and some were constructed with plastic pipes (probably the newest). Sediment in the older drains suggested these no longer carried large flows but some of the newer drains appeared to convey water. Testing showed that some of the newest pipes conveyed water to an outfall in an area to the north of the funnel feature where a natural valley carried water down to the ditch, which also collected water from the drain outfalls described in paragraph G6.
- G10 The investigations were sufficient to establish that the field drains would have a relatively small effect on surface flows during heavy rainfall, due to the time taken for water to percolate through the soil to reach them (although they would reduce long-term waterlogging of the soil). The full extent of field drains was not established. The extent of pipes exposed during investigations is shown on figure G.5. Variations in vegetation colour visible on aerial photographs indicated that the field drain network probably extended most of the way to the side spilling ditch shown on figure 29.



*Figure G.1: Pre-2010 crest drain catchpit between CP10 and CP16 showing drain close to the cutting crest in 2010 (Carillion)*





Figure G.2: View from near CP18 towards CP16 showing alignment of the pre-2010 crest drain and the 2011/12 drain after post-accident vegetation clearance



Figure G.3: Break in pre-2010 crest drain near top of washed out section of 2011/12 drain looking downslope with railway visible in top right-hand corner of image



Figure G.4: Image looking upslope from near CP19 towards CP18 showing damaged end of pre-2010 crest drain close to the as-designed position of CP18. Photograph taken during post-accident investigations with scaffolding over as-built position of CP18 visible in background

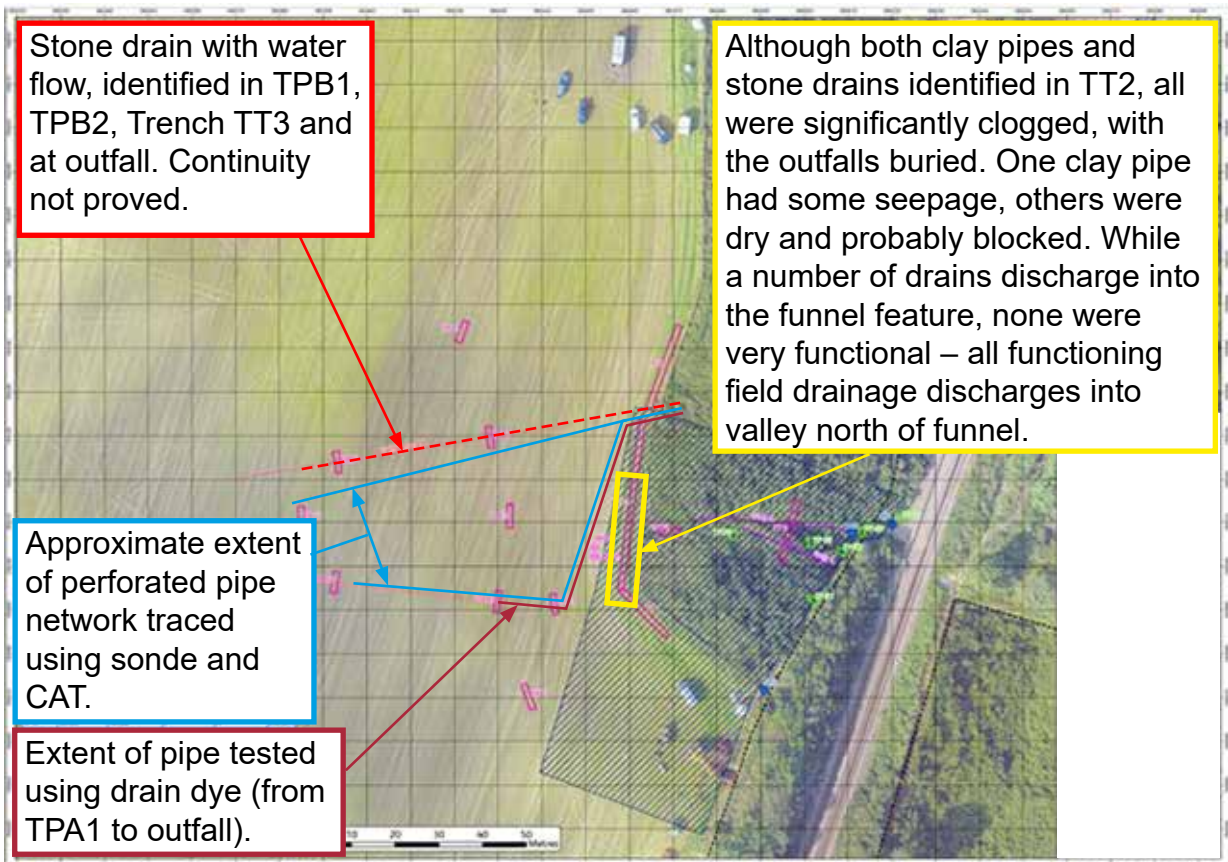

Figure G.5: Field drain survey findings (edited version of Network Rail drawing)

## Appendix H - Analysis of water and debris flows on 12 August 2020

- H1 This appendix summarises selected parts of AECOM's drainage design review, which was commissioned by RAIB to assist investigation of the accident at Carmont (AECOM project number 60648353, report version dated 30 November 2021 together with subsequent correspondence).
- H2 Site topography (ground levels) was derived from LiDAR data obtained shortly after the accident, except in the washout area where LiDAR data obtained in 2018 was used to reflect the ground topography before the washout occurred.
- H3 AECOM's analysis of the 12 August 2020 event used site specific rainfall data derived from radar data provided by the Met Office. AECOM also referred to data from nearby weather stations, in part to confirm that the rainfall derived from radar data was likely to be reliable.
- H4 Ground conditions were established from:
- preliminary records of ground investigation comprising trial pits, trial trenches and boreholes excavated on behalf of Network Rail, with a work scope including input from ORR and RAIB<sup>80</sup>
  - infiltration testing and soil sampling commissioned by RAIB, with input to the work scope from ORR, and undertaken by Dunelm Geotechnical & Environmental Ltd under AECOM's supervision.<sup>81</sup>
- H5 Near-surface soil to a depth of around 0.6 metres is generally described as a clay mixed with varying amounts of gravel, sand and silt. The actual composition of the soil varied significantly over short distances. Areas with larger proportions of clay and fine silt have a lower permeability than those with lower proportions. Lower permeability means water flows more slowly through the soil.
- H6 The amount of rainfall infiltrating into soil depends on both the soil permeability and the extent to which voids between soil particles are already filled with water due to previous rainfall and evaporation. AECOM took account of soil permeability, pre-existing moisture conditions and infiltration test results when selecting parameters for use in its modelling.
- H7 It is impractical to precisely determine, and so impractical to model, the actual distribution of infiltration rates which influenced the surface runoff which reached the 2011/12 drain on 12 August 2020. AECOM therefore considered a range of infiltration rates, each applied over the whole catchment.
- H8 AECOM's analyses considered only surface runoff. Although damp areas of soil associated with springs were seen during dry weather in the field above the funnel feature, and springs appeared to exist in the upper part of the funnel feature, ground water was not explicitly included in the analyses. This was because these flows were considered small compared to the uncertainty about surface flow volumes associated with uncertainty about infiltration. Ground water flows relevant to the washout were considered small because:
- the bedrock encountered a few metres below the ground surface was of low permeability so any flow from this source would be low

<sup>80</sup> Listed in the AECOM report.

<sup>81</sup> Dunelm Geotechnical and Environmental Report Contract S1140 report dated 30 July 2021.

- monitoring equipment inserted into the bedrock identified only low water pressures, indicative of there being little water in the bedrock
- the limited occurrence of coarse grained (relatively high permeability) soil in the soils overlying bedrock meant that the amount of water coming from surface soils would be low
- apparent springs in the upper part of the funnel appeared to be connected to a network of very shallow tunnels, a few centimetres below ground level and a few centimetres in diameter, apparently fed by surface flow at the edge of the adjacent field (hence the flow was effectively part of surface runoff).

H9 The field drainage system in the field upslope of the funnel feature would have diverted some water away from the funnel feature, and it is possible that the historical crest drain contributed a small amount of surface water flow into the area from which material was washed out (appendix G). No explicit allowance has been made for these effects, as flow volumes are likely to have been small compared to uncertainties associated with the amount of infiltration.

### Pipe flows

H10 AECOM considered whether the 2011/12 drain could carry surface runoff from the 12 August rainfall, assuming large flows were not concentrated onto short lengths of drain causing a washout (that is, assuming the drain had been installed as intended by the designer).

H11 AECOM also assessed runoff using the modified rational method, developed by Hydraulic Research (Wallingford) with a technique allowing for the rural nature of the catchment. This runoff was then applied with the MicroDrainage software used to model water flows through the pipes.

H12 This methodology allows selection of different assumptions for the proportion of rainfall which becomes surface runoff (taking account of testing materials found on site) and modelled the actual rainfall event on 12 August 2020. The method does not use site specific data for the slope of the ground, the catchment length (distance from the drain to the furthest point of the catchment) or the surface roughness (vegetation impeding free flow of water over the surface). As topography was not considered, the effect of the bund, and so flows in gully 1, were not modelled.

H13 The AECOM report states that the pipework as designed, and as installed, is of sufficient size to carry the flows calculated using the modified rational method implemented in MicroDrainage software with rainfall data from 12 August 2020. The methodology is based on the system operating as intended, with water reaching the pipework through connections from other pipework<sup>82</sup> or as surface runoff percolating downwards through the gravel and into the perforated pipe. The analysis took no account of washout potential due to the concentrated water flow from gully 1.

---

<sup>82</sup> Specifically, the connection from the burn at the south end of the 2011/12 drain and the as-designed, but not as-built, connection from the pre-2010 ditch.

- H14 It is possible that pipe flows calculated by AECOM are greater than those which would have been obtained by an analysis which took greater account of the rural (unpaved) nature of the drain catchment. The MicroDrainage manual advises against use of the modified rational method if less than 20% of the catchment is paved. A report by the Construction Industry Research and Information Association (CIRIA report C635), indicates that the modified rational method is rarely used for estimating rural catchment peak flows due to the difficulties of estimating the percentage runoff and the time of concentration (that is the difficulties of allowing for soil permeability, surface roughness and catchment length).<sup>83</sup> Paved and other near-impermeable surfaces in urban areas mean water usually reaches drains more rapidly than in rural areas, so the duration of flow in drains is shorter but the peak flow rate, which determines pipe size, is larger.
- H15 In reviewing AECOM’s conclusion concerning pipe performance on 12 August 2020, RAIB notes it is consistent with site observations which showed no evidence that parts of the 2011/12 drain upstream of gully 1 had suffered damage. Upstream of CP16, the pipes in this drain were at a shallower gradient, so had significantly less flow capacity, albeit they were expected to carry less water, than downstream of CP16.
- H16 The flows reaching the 2011/12 drain obtained using the modified rational method with the as-built drain layout are summarised in table H.1. Similar results were obtained using the as-designed drain layout. The practical difficulty of assessing the proportion of rainfall which becomes surface runoff means that the table includes AECOM’s best estimate value (most likely soil type with most likely amount of water in the soil at the start of the storm) and results from a sensitivity analysis to assess the effect of varying this.

		<b>Percentage of rainfall becoming surface runoff (obtained using PRrural method)</b>	
		<b>Best estimate</b> <b>39%</b>	<b>Sensitivity range</b> 35%-51%
<b>Peak flow (litres/sec) reaching the 2011/12 drain from</b>	upstream of CP16	287	263 to 292
	CP16 to CP19 *	129	121 to 226
	whole catchment	416	384 to 518
* the bund affected the route taken by (but not the total amount of) runoff arriving between CP16 and CP19			

Table H.1: Surface water flows reaching pipes on 12 August 2020 (rounded results given in, or derived from, AECOM report, appendix L, table A.1)

<sup>83</sup> CIRIA report C635, ‘Designing for exceedance in urban drainage – good practice’ (2006).

## Overland flows

- H17 AECOM also undertook an analysis of overland surface water flows using a method considerably more sophisticated than normally applied for routine design of drains like that at Carmont. This used the Tuflow software package and took account of the actual surface topography, soil type and soil saturation based on rainfall data relating to the days before the accident. The effect of the bund, thus the quantification of flows in gully 1, was included in this analysis. The practical difficulty of measuring and modelling some soil parameters again meant that AECOM considered best estimate parameters and undertook a sensitivity analysis to assess the effect of variations from these.
- H18 The best-estimate analysis considered the full catchment area as a sandy loam soil with an initial moisture content (the proportion of the soil already wet before the event began) assessed as 17%. Loamy sand and silt loam, respectively more and less permeable than sandy loam, and initial moisture contents ranging from 0% to 20% were also considered, together with a range of ground roughness values. Results and details of all analyses are given in the AECOM report. Selected numerical results from this modelling are presented in table H.2 and show clear evidence that gully 1, the consequence of the bund, provides the concentrated flow needed to cause the washout.
- H19 Selected plots of output obtained from the overland flow modelling are included earlier in this report. The modelling and interpretation of the output takes account of site observations showing that, on 12 August 2020, water reaching the 2011/12 drain upslope of gully 1 almost certainly percolated through the gravel and into the perforated pipe. It was not practical to fully reflect this scenario in the computer software output which included a small surface flow over the 2011/12 drain upslope of gully 1. A correction for this is included in the numerical results given in table H.2, but no corresponding adjustment was practical on the plots included as figures 41 and 42.

<b>Tuflow overland flow analysis</b>		<b>Best estimate</b>	<b>Range</b>	
		sandy loam 17% IMC	sandy loam 0% - 20% IMC	
<b>Peak flow (litres/sec) reaching the 2011/12 drain from</b>	upstream of CP16	290	130 - 320	
	CP16 to CP19	upslope of gully 1 +	40	30 - 40
		gully 1	<b>140</b>	80 - 150
IMC initial moisture content + It is likely that this water percolated downwards through gravel and entered the perforated pipe before reaching the washout area Small amounts of water entering drain between gully 1 and the outfall are not included above				

*Table H.2: Surface water flows reaching pipes on 12 August 2020 – Overland water flow analysis (rounded results given in, or derived from, AECOM report, appendix C, table 10)*

## Sediment flow

- H20 The extent and timing of erosion in the washout area and deposition on the railway was assessed by AECOM using a sediment flow assessment. This used ground topography derived from the LiDAR data, soil data from the Network Rail ground investigation and methodologies described by Takahashi<sup>84</sup> to identify areas of the 2011/12 drain liable to washout. Sediment flow was then assessed using the Debris Flow module of the Rapid Mass Movements Simulation software.
- H21 The purpose of the analyses was to determine whether overland water flows were sufficient to explain, and therefore the likely cause of, the observed washout (no evidence of other causes was found). The complex analytical methods used rely on parameters which could not be established with certainty from testing material on site. However, the analyses demonstrate that the observed behaviour of water flows was consistent with realistic parameter values.
- H22 Ground parameters were not adjusted from initial estimates in order to try and match observed volumes of eroded material. This was not considered worthwhile given the aims of the work and the fact that the model did not allow for material not deposited in the main area of deposition (the 'fan'). This comprised some material washed into Carron Water and some deposited in a depression alongside the track. Although there is no direct evidence of material washed into Carron Water, the natural soil found at the site, and the 'gravel' fill in the drain, include small particles which would be expected to remain in suspension (carried by the water) until it reached Carron Water.
- H23 Although the best estimate flow along gully 1 is 140 litres/sec (table H.2), the sediment flow assessment results presented in figure 44 are for surface flows on the 2011/12 drain of 86 litres/sec. The flow used reflects the possibility that actual gully flows were less than the best estimate, and the likelihood of some water from gully 1 percolating through the gravel and into the perforated pipe. The extent of percolation cannot be established, in part because fine material washed into the spaces between gravel particles (paragraph 148) would have reduced the percolation rate to less than the approximately 14 litres/sec per metre run of drain calculated by AECOM for 'clean' gravel. The value of 86 litres/sec was based on engineering judgement with the exact value chosen from those available in Tuflow outputs.
- H24 Modelling with surface flows of 86 litres/sec on the washout area of the 2011/12 drain is considered sufficient to show that overland flow due to rainfall on 12 August 2020 is the explanation for debris being deposited on the track. This analysis showed 13 m<sup>3</sup> of material eroded from the drain and adjacent ground, all deposited in a fan with shape and depths as shown on figures 43 and 44. This calculated volume can be compared with an eroded volume of 23 m<sup>3</sup> and a fan volume of 16 m<sup>3</sup> calculated by RAIB from post-accident surveys.

---

<sup>84</sup> Tamashaki, T. 'Debris Flow Mechanics, Predictions and Countermeasures', Taylor & Francis, 2014.

H25 The modelling based on 86 litres/sec shows washout of material from in and around the drain starting after 08:20 hrs and finishing by 09:05 hrs. Similar times are obtained for gravel surface flow by considering the best estimate flows shown on figure 44 and assuming the low flows initially coming from gully 1 percolate into the pipe. Taking account of the relatively small flows from gully 1 at the beginning and end of the flow period, RAIB considers it most likely that the washout affected the railway between approximately 08:30 hrs and 09:00 hrs.

#### Outflow from around drainage pipe on downslope side of catchpit 18

H26 AECOM's report shows that, once gravel had been washed out from the drain near the downslope side of CP18, around 30% of water leaving the downstream side of CP18 during periods of relatively high flow would do so by escaping from around the pipe, a consequence of the site-cut holes in the catchpit being larger than the pipe (paragraphs 149 and 151). Comparison of surface flow catchment areas, and output from AECOM's modified rational method analysis,<sup>85</sup> showed that more water entered the drain upslope of CP16 and then passed through CP18, than fed gully 1. The amount of water escaping from around the pipe was therefore sufficient to influence how debris was distributed, but it is impractical to accurately model this effect. However, RAIB has concluded that the washout of the drain downslope of CP18 would still have occurred without the presence of escaping water from around the pipe at CP18. This is because the drain erosion upslope of CP18 shows that the water from gully 1 alone was sufficient to cause a washout.

---

<sup>85</sup> The modified rational method calculation and the calculation for establishing the amount of water escaping used different analytical techniques. This resulted in different relationships between water level in CP18 and the amount of downstream flow. The difference is not sufficient to invalidate the concept presented above.



# Appendix J - Weather forecast for Scotland issued 02:51 hrs 12 August 2020



## Scotland Route 5 Day Forecast

Issued on Wednesday 12 Aug 2020 at 02:51 BST by Matt Andrews  
Valid for 06:00 Wednesday 12 Aug 2020 to 06:00 Monday 17 Aug 2020

For further information on this forecast please call the Network Rail Forecaster on 01296 628 372

### Forecast - 24 hours (weather and hazard summary)

Thunderstorms across central, northern and eastern parts of Scotland will slowly clear to the north-east this morning, but before they clear they could turn particularly potent the north-east with frequent lightning and hail, with the risk 10-15mm will fall within one hour in places. These storms should have cleared into the North Sea by the early afternoon with a mixture of sunny spells and scattered showers developing elsewhere. These showers could turn heavy across the Highlands, with the risk some isolated thunderstorms will edge into southern parts of Motherwell and Edinburgh later this afternoon. These isolated thunderstorms in southern Scotland could bring frequent lightning alongside the risk of around 10mm falling within an hour. The storms should fade away overnight leaving most places dry, but with some low cloud and mist forming in places.

Rainfall - 24hr rainfall totals across Aberdeenshire could exceed 30mm from the thunderstorms expected through this morning.

### Forecast - 2 to 5 Days (weather and hazard summary)

Variable amounts of cloud around tomorrow with a few showers around, although most of these look to be light and well scattered. A few scattered showers could linger across southern Scotland, but elsewhere it will become mainly dry, but with a fair amount of cloud around. More in the way of sunshine on Friday with a few scattered showers possible for southern and eastern areas. A dull start to Saturday with some low cloud and mist around, but this should clear to leave a mainly dry day with sunny spells. Very similar on Sunday with sunny spells and just the odd shower.

Summary Hazards - Perth (Scotland)																				
Day (0600 to 0600)	Wind		Heavy Rain Accum.		Convective Rainfall Intensity		Lightning Risk		Snow		Frost		Max Temp (06-18)	Min Temp (18-06)	Temp Range		Ice Day		Freezing Fog	
	Hazard	Conf.	Hazard	Conf.	Hazard	Conf.	Hazard	Conf.	Hazard	Conf.	Hazard	Conf.			Hazard	Conf.	Hazard	Conf.	Hazard	Conf.
Wed		High	Extreme	Low	Aware	Low	Adverse	Medium		High		High	25.5	11.0		High		High		High
Thu		High		High		High		High		High		High	23.5	9.5		High		High		High
Fri		High		High		High		High		High		High	20.5	8.5		High		High		High
Sat		High		High		High		High		High		High	23.0	9.0		High		High		High
Sun		High		High		High		High		High		High	23.0	8.5		High		High		High

Summary Hazards - Glasgow (Scotland)																				
Day (0600 to 0600)	Wind		Heavy Rain Accum.		Convective Rainfall Intensity		Lightning Risk		Snow		Frost		Max Temp (06-18)	Min Temp (18-06)	Temp Range		Ice Day		Freezing Fog	
	Hazard	Conf.	Hazard	Conf.	Hazard	Conf.	Hazard	Conf.	Hazard	Conf.	Hazard	Conf.			Hazard	Conf.	Hazard	Conf.	Hazard	Conf.
Wed		High		Low		Low	Aware	Low		High		High	25.0	13.0		High		High		High
Thu		High		High		High		Low		High		High	23.5	11.5		High		High		High
Fri		High		High		High		High		High		High	23.0	11.5		High		High		High
Sat		High		High		High		High		High		High	23.5	10.5		High		High		High
Sun		High		High		High		High		High		High	24.0	8.5		High		High		High

Summary Hazards - Highland (Scotland)																				
Day (0600 to 0600)	Wind		Heavy Rain Accum.		Convective Rainfall Intensity		Lightning Risk		Snow		Frost		Max Temp (06-18)	Min Temp (18-06)	Temp Range		Ice Day		Freezing Fog	
	Hazard	Conf.	Hazard	Conf.	Hazard	Conf.	Hazard	Conf.	Hazard	Conf.	Hazard	Conf.			Hazard	Conf.	Hazard	Conf.	Hazard	Conf.
Wed		High		Low		Low	Adverse	Medium		High		High	23.5	12.5		High		High		High
Thu		High		High		High		High		High		High	22.5	9.5		High		High		High
Fri		High		High		High		High		High		High	21.5	10.5		High		High		High
Sat		High		High		High		High		High		High	22.5	11.0		High		High		High
Sun		High		High		High		High		High		High	22.0	9.0		High		High		High

Summary Hazards - Motherwell (Scotland)																				
Day (0600 to 0600)	Wind		Heavy Rain Accum.		Convective Rainfall Intensity		Lightning Risk		Snow		Frost		Max Temp (06-18)	Min Temp (18-06)	Temp Range		Ice Day		Freezing Fog	
	Hazard	Conf.	Hazard	Conf.	Hazard	Conf.	Hazard	Conf.	Hazard	Conf.	Hazard	Conf.			Hazard	Conf.	Hazard	Conf.	Hazard	Conf.
Wed		High	Aware	Low	Aware	Low	Adverse	Low		High		High	27.5	14.5		High		High		High
Thu		High		Medium		Medium	Aware	Low		High		High	25.0	12.0		High		High		High
Fri		High		Medium		Medium		Medium		High		High	23.0	11.0		High		High		High
Sat		High		High		High		High		High		High	23.5	10.5		High		High		High
Sun		High		High		High		Medium		High		High	23.0	9.0		High		High		High

Summary Hazards - Edinburgh (Scotland)																				
Day (0600 to 0600)	Wind		Heavy Rain Accum.		Convective Rainfall Intensity		Lightning Risk		Snow		Frost		Max Temp (06-18)	Min Temp (18-06)	Temp Range		Ice Day		Freezing Fog	
	Hazard	Conf.	Hazard	Conf.	Hazard	Conf.	Hazard	Conf.	Hazard	Conf.	Hazard	Conf.			Hazard	Conf.	Hazard	Conf.	Hazard	Conf.
Wed		High	Aware	Low	Aware	Low	Adverse	Low		High		High	24.5	14.0		High		High		High
Thu		High		Medium		Medium	Aware	Low		High		High	21.0	11.5		High		High		High
Fri		High		Medium		Medium		Medium		High		High	19.0	11.5		High		High		High
Sat		High		High		High		High		High		High	21.0	10.0		High		High		High
Sun		High		High		High		Medium		High		High	19.5	10.5		High		High		High

48 Hour Snow Summary - Scotland						
Sub-route	Wednesday			Thursday		
	Depth (cm)	Drifting	Snow Type	Depth (cm)	Drifting	Snow Type
Perth	0			0		
Glasgow	0			0		
Highland	0			0		
Motherwell	0			0		
Edinburgh	0			0		

24 Hour Wind Table - 0600 Wednesday 12 Aug to 0600 Thursday 13 Aug - Scotland								
Sub route	0600-1200		1200-1800		1800-0000		0000-0600	
	Mean (MPH) and Dir	Gust (MPH)	Mean (MPH) and Dir	Gust (MPH)	Mean (MPH) and Dir	Gust (MPH)	Mean (MPH) and Dir	Gust (MPH)
Perth	NE 5-10	10-15	NW 5-10	15-20	NW 5-10	20-25	NW 10-15	15-20
Glasgow	NO-5	10-15	NW 5-10	15-20	N 10-15	15-20	N 10-15	15-20
Highland	NO-5	10-15	NO-5	10-15	NE 5-10	10-15	NE 5-10	10-15
Motherwell	N 5-10	15-20	NW 10-15	20-25	NW 5-10	20-25	NE 5-10	20-25
Edinburgh	NW 5-10	10-15	N 5-10	20-25	E 1-5	10-15	N 5-10	15-20

Saltcoats - 0600 Wednesday 12 Aug to 0600 Thursday 13 Aug - Scotland	
Sea state	Smooth
Spray	Nil
High tide	0614 and 1845
Wind speed and direction on the coast	Easterly 5-10mph

Issued on Wednesday 12 Aug 2020 at 02:51 BST by Matt Andrews  
 For further information on this forecast please call the Network Rail Forecaster on 01296 628 372

## Appendix K - Previous RAIB recommendations and responses

Recommendations are presented in the following order:

**CLASS INVESTIGATION**    **Class investigation into landslips affecting Network Rail infrastructure**

**LAMINGTON**                **Structural failure caused by scour at Lamington viaduct, South Lanarkshire**

**WATFORD**                    **Derailment due to a landslip, and subsequent collision, Watford**

ORR provide RAIB with information about actions taken in response to RAIB recommendations. This includes details of the information provided to ORR by the end implementer and can be found at <https://www.orr.gov.uk/monitoring-regulation/rail/promoting-health-safety/investigation-enforcement-powers/handling-raib-recommendations>

<b>CLASS INVESTIGATION</b>	
<b>Class investigation into landslips affecting Network Rail infrastructure</b>	
<b>Recommendation number</b>	<b>3</b>
Event dates	28 June 2012 to 11 February 2013
RAIB report ref	<a href="#">08/2014</a>
RAIB report publication date	2 April 2014
Date of last update from implementer to ORR	15 December 2015
Date of last ORR decision sent to RAIB	9 February 2016
Recommendation status in last ORR decision	Implemented

### ***Recommendation intention and text***

(the italicised intent is not part of the formal recommendation)

*The intent of this recommendation is to increase the likelihood that appropriate Network Rail staff are aware of landslip risk due to adverse rainfall conditions which have not been forecast or detected by Network Rail’s formal rainfall monitoring processes.*

Network Rail should implement a process for real-time collection (and appropriate use of) intelligence about very unusual rainfall or flooding conditions. Development of this process should take into account the differing risk levels on different parts of the infrastructure and should consider using the following information sources:

- emergency service control centres;
- other organisations involved in the provision and management of rail and non-rail transport;
- reports (encouraged by appropriate railway industry publicity) from on-duty and off-duty railway industry staff including those employed by train operating and maintenance companies; and;
- rain gauge and other types of weather sensor capable of providing data in real time.

<b>CLASS INVESTIGATION</b>	
<b>Class investigation into landslips affecting Network Rail infrastructure</b>	
<b>Recommendation number</b>	<b>5</b>
Event dates	28 June 2012 to 11 February 2013
RAIB report ref	<a href="#">08/2014</a>
RAIB report publication date	2 April 2014
Date of last update from implementer to ORR	6 July 2016
Date of last ORR decision sent to RAIB	11 January 2017
Recommendation status in last ORR decision	Implemented

***Recommendation***

(the italicised intent is not part of the formal recommendation)

*The intent of this recommendation is for Network Rail to formalise the process for dealing with the rare circumstances when the mitigation normally provided in response to a red warning would be inadequate. This requires consideration of additional mitigation for locations on the ‘at risk’ register and consideration of mitigation for locations which are not normally considered to be at risk during extreme weather conditions.*

Network Rail should formalise the process for implementing additional mitigation if very extreme rainfall conditions mean that the mitigation normally provided in response to a red warning is inadequate for earthworks on the ‘at risk’ register and/or there is a significant likelihood of landslips at locations not included on this register.

<b>LAMINGTON</b>	
<b>Structural failure caused by scour at Lamington viaduct, South Lanarkshire</b>	
<b>Recommendation number</b>	<b>3</b>
Event date	31 December 2015
RAIB report ref	<a href="#">22/2016</a>
RAIB report publication date	14 November 2016
Date of last update from implementer to ORR	3 December 2019
Date of last ORR decision sent to RAIB	7 December 2020
Recommendation status in last ORR decision	Implemented

***Recommendation intention and text***

(the italicised intent does not part of the formal recommendation)

*The intent of this recommendation is to ensure that the latest version of all relevant documentation and processes are being used by control room staff. The documentation and other processes should be updated and checked periodically to ensure that they remain fit for purpose.*

Network Rail should review and improve the management and assurance systems for all control centre processes relating to the safety of railway infrastructure used by Scotland Route. The review should encompass both documented processes and the way they are implemented. It should include:

- procedures directly relevant to control room staff;
- inputs required from other parts of Network Rail;
- inputs required from external organisations; and
- arrangements for prompt updating and periodic verification of processes.

Any lessons learnt should be applied to other Routes as necessary.

<b>WATFORD</b>	
<b>Derailment due to a landslip, and subsequent collision, Watford</b>	
<b>Recommendation number</b>	<b>3</b>
Event date	16 September 2016
RAIB report ref	<a href="#">11/2017</a>
RAIB report publication date	10 August 2017
Date of last update from implementer to ORR	20 December 2017
Date of last ORR decision sent to RAIB	9 August 2018
Recommendation status in last ORR decision	Progressing

***Recommendation intention and text***

(the italicised intent is not part of the formal recommendation)

*The intent of this recommendation is to identify and assess the effectiveness of design features that provide guidance to trains when derailed, so limiting the deviation of trains from the track and reducing the risk of collision with trains approaching on other lines. This could be achieved by the retention or strengthening of features already forming part of the bogie structure, or infrastructure measures such as guard rails. It is also intended that the learning from research in this area is used to derive meaningful design requirements.*

The Rail Delivery Group (RDG), in conjunction with RSSB, should:

- a. commission research into the ways in which guidance can be provided to derailed trains. This should include consideration of:
  - how the design of bogies and bogie mounted equipment can assist in limiting the lateral deviation of passenger trains during a derailment;
  - practice in other countries (eg Japan);
  - how specially installed infrastructure features can achieve the same effect at high risk locations;
  - potential design requirements for the retention or enhancement of such features on new trains or infrastructure; and
  - the potential benefits and drawbacks of such measures.

If such features, whether existing or additional, are shown to have a net beneficial effect in reducing risk by limiting lateral deviation, RDG/RSSB should:

- b. share this information with the relevant Standards Committees; and
- c. record and disseminate the design requirements with a view to their incorporation into future standards.

## Appendix L - Previous occurrences

<b>Location</b>	<b>Date</b>	<b>RAIB reference</b>	<b>RAIB Report title</b>
Baildon	7 June 2016	<a href="#">Report 03/2017</a>	Trains passed over washed out track at Baildon, West Yorkshire
Bargoed	30 January 2013	<a href="#">Report 08/2014</a>	Class investigation into landslips affecting Network Rail infrastructure between June 2012 and February 2013
Clarborough	27 April 2012	<a href="#">Bulletin 02/2012</a>	Derailment at Clarborough tunnel, near Retford, Nottinghamshire
Corby	13 June 2019	<a href="#">Report 04/2020</a>	Train collision with material washed out from a cutting slope at Corby, Northamptonshire
Dock Junction and Kentish Town	26 May 2011	<a href="#">Report 07/2012</a>	Safety incident between Dock Junction and Kentish Town
East Somerset Junction	10 November 2008	<a href="#">Report 28/2009</a>	Derailment of two locomotives at East Somerset Junction, Somerset
Falls of Cruachan	18 July 2012	<a href="#">Report 08/2014</a>	Class investigation into landslips affecting Network Rail infrastructure between June 2012 and February 2013
Froxfield	22 February 2015	<a href="#">Report 02/2016</a>	Collision between a train and a fallen bridge parapet at Froxfield, Wiltshire
Gillingham	28 November 2009	<a href="#">Report 19/2010</a>	Derailment near Gillingham tunnel, Dorset
Grayrigg	23 February 2007	<a href="#">Report 20/2008</a>	Derailment at Grayrigg
Knockmore	28 June 2012	<a href="#">Report 14/2013</a>	Train ran onto a washed-out embankment near Knockmore, Northern Ireland
Lamington	31 December 2015	<a href="#">Report 22/2016</a>	Structural failure caused by scour at Lamington viaduct, South Lanarkshire
Laurencekirk/Portlethen	4 December 2020	<a href="#">Report 08/2021</a>	Trains overspeeding between Laurencekirk and Portlethen, Aberdeenshire
Lewisham	2 March 2018	<a href="#">Report 02/2019</a>	Self-detrainment of passengers onto open lines that were still open to traffic and electrically live at Lewisham, south-east London
Loch Treig	28 June 2012	<a href="#">Report 08/2014</a>	Class investigation into landslips affecting Network Rail infrastructure between June 2012 and February 2013

<b>Location</b>	<b>Date</b>	<b>RAIB reference</b>	<b>RAIB Report title</b>
Margam	3 July 2019	<a href="#">Report 11/2020</a>	Track workers struck by a train at Margam
Oubeck North	4 November 2005	<a href="#">Report 19/2006</a>	Derailment at Oubeck North near Lancaster
Reading and Ruscombe	28 March 2015 and 3 November 2015	<a href="#">Report 18/2016</a>	Two signals passed at danger incidents at Reading Westbury Line Junction and Ruscombe Junction
Rosyth	18 July 2012	<a href="#">Report 08/2014</a>	Class investigation into landslips affecting Network Rail infrastructure between June 2012 and February 2013
Sandilands junction	9 November 2016	<a href="#">Report 18/2017</a>	Overtaking of a tram at Sandilands junction
Shap	17 August 2010	<a href="#">Report 15/2011</a>	Uncontrolled freight train run-back between Shap and Tebay, Cumbria
St Bees	30 August 2012	<a href="#">Report 08/2014</a>	Class investigation into landslips affecting Network Rail infrastructure between June 2012 and February 2013
Summit tunnel	28 December 2010	<a href="#">Report 16/2011</a>	Derailment in Summit tunnel, near Todmorden, West Yorkshire
Watford tunnel	16 September 2016	<a href="#">Report 11/2017</a>	Derailment due to a landslip, and subsequent collision, Watford



## Appendix M - Bridge 328

- M1 RAIB has considered whether learning relevant to the Carmont investigation can be drawn from an unsafe event on Friday 15 January 2021 at bridge 328, a bridge similar to that struck by train 1T08 on 12 August 2020. RAIB has concluded that the circumstances leading to the failure of the parapet wall at bridge 328 are not relevant to the accident on 12 August 2020. Specifically, the masonry parapet wall at bridge 328, and the handrail it supported, were pushed away from the track by ballast placed against the side of the wall. The parapets at bridge 325 fell in response to forces caused when the walls were struck by train 1T08.
- M2 On Friday 15 January 2021, two trains crossed bridge ECN5 133/328 (bridge 328) on the up line after part of the bridge parapet on the up (east) side of the bridge had failed. Despite this, neither train was affected by the incident. The bridge is located between Carmont and Stonehaven at 222 miles 120 yards, about 1.8 km north-east of bridge 325. Both bridges, and the intermediate bridge 326, are of a similar age and design. Each bridge spans Carron Water.
- M3 Evidence from CCTV on passing trains shows that the parapet of bridge 328 was intact at 08:55 hrs but had failed by 09:24 hrs. Services were subsequently suspended until 22 February 2021 while repairs were in progress.
- M4 An examination of the site by Network Rail staff after the failure was first reported found that a 24-metre length of parapet towards the north end of the bridge had collapsed onto the embankment below (figure M.1). Photographs from the site show that the vertical ends of the up-line sleepers were exposed in the area of the failure (figure M.2). The sleepers were not undermined, and the track did not become distorted. The adjacent down line was unaffected.



Figure M.1: South-east corner of bridge 328 following the failure of part of its parapet wall on 15 January 2021 (Network Rail)



Figure M.2: Up line on bridge 328 looking south on 15 January 2021 (Network Rail)

- M5 An investigation undertaken by Network Rail found that the parapet had become pushed outwards by deep ballast on the bridge. Additional ballast had been placed as part of a track upgrade undertaken between 1980 and 1993. During this project, jointed rail was changed to continuous welded rail. The depth of the ballast was increased to support the stresses and forces generated by the rail being welded together and stressed and to allow train speeds to be increased. There was no evidence that the parapet wall had been designed to carry forces from the ballast and its failure was exacerbated by the presence of existing defects in the parapet and wingwall.
- M6 Structures inspections over several years had identified displacement of the parapet. However, recommendations to monitor the defect or install ties to reinforce the structure were deferred and not implemented.
- M7 Three technical causes of failure were identified by the investigation:
- a) The collapse was due to the application of a lateral (horizontal) force to the parapet which the parapet was not strong enough to resist.
  - b) The parapet was pushed outwards. This was likely to have been due to a combination of the depth of track construction adjacent to the parapet, and additional horizontal forces transferred through the track construction to the parapet during the passage of trains.
  - c) The applied forces resulted in lateral movement of the parapet, which appears to have either rotated about the string course or slid at the string course.

M8 The Network Rail investigation acknowledged actions already taken following the incident and made recommendations. These addressed the management and control of high ballast levels over bridges; improving the identification of infrastructure by signallers in the area of a reported problem; the competency requirements for staff providing confirmation that an adjacent line is clear; and the design of retrofitted handrails in short discontinuous lengths.

#### Comparison of failure mechanisms between bridge 328 and 325

M9 RAIB has concluded that the failure mechanism for the parapet wall at bridge 328 is fundamentally different to that at bridge 325. The failure at bridge 328 was a movement away from the track due to lateral forces from the ballast pushing against the side of the wall. This caused the parapet to break on a horizontal line near the bottom of the wall just above the string course.

M10 On bridge 325, three layers of masonry (including the coping stones) were displaced at the south end of the down-side wall but, within a few metres of this end, the damage was largely limited to displaced coping stones (figures F.5 and F.6). This pattern is consistent with a force applied approximately parallel to the wall as train 1T08 struck the south end of it. At the opposite corner of the bridge near the north end of the up-side wall, five layers of masonry (again including the coping stones) broke off just above the string course for a distance of about 9 metres. Evidence that this was caused by train 1T08 is provided by scrape marks on the adjacent section of intact wall, by the presence of masonry blocks projected beyond the north end of the wall and by train debris which had crossed the up line and reached the up-side cess, a trajectory consistent with it striking the up-side parapet. This debris included the underframe of a passenger coach found in the up-side cess, just beyond the north end of the parapet wall (figure F.8).

M11 The long-standing longitudinal fractures along the back of the stone blocks forming the arch ring at bridge 325, described at paragraph F24, were due to lateral forces with some similarities to those causing the failure at bridge 328. However, the fractures at bridge 325 are not relevant to the failure of the parapet wall during the accident on 12 August 2020.

## Appendix N - Drainage design

- N1 RAIB, assisted by AECOM, reviewed elements of Arup’s design work potentially relevant to events on 12 August 2020 and concluded that these were not factors in the accident. Selected findings are summarised below.
- N2 The overall catchment area for the drain, and the areas of land draining into each part of the 2011/12 drain, differed between Arup’s design based on LiDAR data available in 2010 and higher resolution (more accurate) LiDAR data available after the accident. The total catchment area was assessed by Arup as 13.4 ha and by AECOM as 11.0 ha. The differences did not affect the accident and appear to be the consequence of differing LiDAR accuracies, with the post-accident survey being more accurate than normally required for designing drains of this type.<sup>86</sup>
- N3 The LiDAR data used by Arup lacked the accuracy needed to show the funnel feature, but this was shown on additional survey data which was provided to Arup in May 2010 (paragraph 95 and figure 33). The two sets of data are compared on figure N.1.

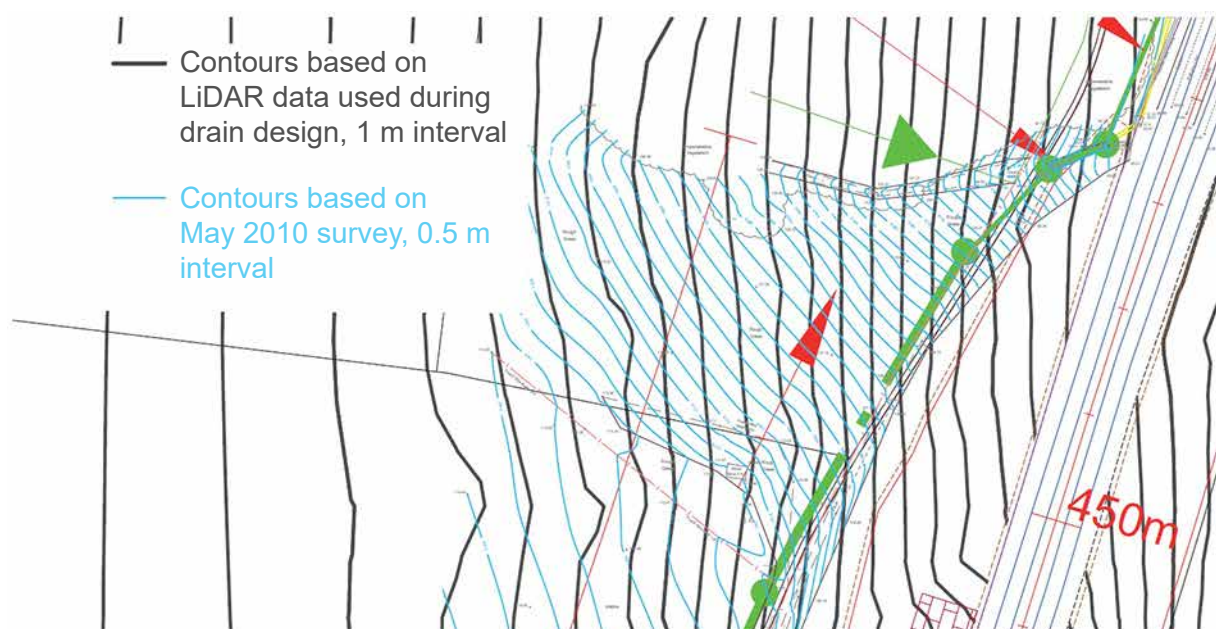

Figure N.1: Funnel area contours compared

- N4 Some unwanted material excavated during construction of the 2011/12 drain was placed on the southern face of the funnel feature, so it is shown on the post-accident LiDAR survey, but not on the May 2010 survey. There is no evidence suggesting that the placement of this material affected the accident.
- N5 Network Rail standards applicable in 2010 did not specify the method to be used to calculate the amount of water reaching each part of the 2011/12 drain. Arup used the Institute of Hydrology Report 124 (IH124) method. AECOM confirmed that the Arup calculations were in accordance with this.

<sup>86</sup> For example, UK national highways authorities permit use of contours shown on 1:25 000 Ordnance Survey mapping.

- N6 Arup used the IH124 method on the basis that it was permitted for design of drains such as that at Carmont by the version of 'Sewers for Scotland' applicable in 2010.<sup>87</sup> Although a different design method was given for the design of similar national road drainage schemes in 2010, this method was replaced by IH124 when national road drainage design guidance was updated in March 2020.<sup>88</sup>
- N7 AECOM's analyses demonstrated that the as-designed pipework at Carmont was capable of carrying the flows likely to have occurred on 12 August 2020, provided these had reached the drain distributed along its length rather than as a concentrated flow such as that from gully 1. Since December 2018, module 9 of Network Rail standard NR/L2/CIV/005 has required drain designers to consider a range of design methods.<sup>89</sup> Analysis by AECOM showed that significantly different design flows are obtained if alternative design methodologies are used but, as pipe capacity was not a cause of the accident, these are not considered further in this report.
- N8 Arup's design submission sent to Network Rail in 2010 included a certificate stating that the calculations had been checked. Contrary to its own quality assurance system, Arup design records available after the accident did not include evidence, for example the checker's initials on the calculations, demonstrating that this had happened.

---

<sup>87</sup> 'Sewers for Scotland', Scottish Water, 2<sup>nd</sup> edition, 2001.

<sup>88</sup> 'Design manual for roads and bridges', published by the national highways authorities, contained HA106/04, dated February 2004, until replaced in March 2020 by CD522; both titled 'Drainage of runoff from natural catchments'.

<sup>89</sup> Network Rail standard NR/L2/CIV/005 module 9 'Drainage Design'.

## Appendix P - Railway standards

### Network Rail company standards

<b>Reference number</b>	<b>Title</b>	<b>Date of selected issues (compliance date)</b>
NR/L2/CIV/005	Drainage Systems	Issue 01 – 2 June 2018 (3 December 2018)
NR/L2/CIV/005 module 1	Drainage Asset Maintenance	2 June 2018 (3 December 2018)
NR/L2/CIV/005 module 9	Drainage Design	2 June 2018 (3 December 2018)
NR/L2/CIV/086	Management of Earthworks Manual	Issue 01 – 2 March 2019 (2 March 2019)
NR/L2/CIV/086 module 4	Earthwork Interventions	2 September 2017 (31 December 2017)
NR/L2/CIV/086 module 9	Earthworks Adverse/ Extreme Weather Risk Assessment	2 September 2017 (31 December 2017)
NR/L2/INF/02202	Records management of health and safety files	Issue 04 – 5 September 2009 (5 December 2009)  Issue 05 – 4 June 2011 (3 December 2011)
NR/L2/INI/02009 (updated and reissued as NR/L2/RSE/02009)	Engineering management for projects	Issue 04 – 5 December 2009 (6 March 2010)  Issue 05 – 4 June 2011 (3 September 2011)
NR/L2/INI/CP0047	Application of the Construction Design and Management Regulations to Network Rail construction works	Issue 04 – 6 March 2010 (31 March 2010)
NR/L2/MTC/088	Maintenance of new and changed assets	Issue 04 – 6 June 2009 (5 September 2009)
NR/L2/OHS/003	Fatigue risk management	Issue 09 – 07 December 2019 (29 October 2022)
NR/L2/OPS/021 (formerly NR/L2/OCS/021)	Weather - Managing the Operational Risk	Issue 05 – 4 June 2011 (4 June 2011)  Issue 06 – 5 March 2016 (4 June 2016)  Issue 08 – 1 June 2019 (07 September 2019)
NR/L2/OPS/250	Network Rail National Emergency Plan	Issue 07 – 2 March 2019
NR/L2/TRK/001 module 3	Plain line track	Issue 08 – 3 September 2016 (3 September 2016)

<b>Reference number</b>	<b>Title</b>	<b>Date of selected issues (compliance date)</b>
NR/L2/TRK/2102	Design and construction of track	Issue 08 – 3 September 2016 (1 March 2017)
NR/L3/CIV/065	Examination of Earthworks Manual	Issue 06 – 2 September 2017 (31 December 2017)
NR/L3/CIV/065 module 2	Definition of soil cutting hazard index	Issue 01 – 2 September 2017 (31 December 2017)
NR/L3/CIV/185	Management of Reports of Safety Related Geotechnical Incidents	First issued September 2017, Issue 03 – 5 September 2020 (5 September 2020) Similar geotechnical incident data collected under earlier standards
NR/L3/EBM/089 aka NR/L3/MTC/089	Asset Management Plan	Issue 01 – 6 June 2009 (5 September 2009)
NR/L3/INI/CP0071	Principal contractor licensing requirements	Issue 01 – 1 March 2008 (1 March 2008)
NR/L3/OPS/021 module 8	Earthworks	Issue 01 - 1 June 2019 (7 September 2019)
NR/L3/OPS/021 module 12	Flooding- Management of Drainage	Issue 01 – 5 September 2020 (5 September 2020)
NR/L3/OPS/045/2.02	Controller Competence Assessment Process	Issue 03 – 7 December 2019 (7 March 2020)
NR/L3/OPS/045/3.17	Weather Arrangements	Issue 03 – 6 June 2020 (6 June 2020)
NR/L3/OPS/045/4.15	Managing Stranded Trains and Train Evacuation	Issue 01 – 2 September 2017 (2 September 2017)
NR/L3/TRK/1010	Management of responses to extreme weather conditions at structures, earthworks & other key locations	Issue 02 – 26 August 2008 (26 August 2008)

Railway Group and Industry Standards (issued by RSSB)

<b>Reference number</b>	<b>Title</b>	<b>Date of selected issue (in force date)</b>
GM/RT2100	Structural requirements for railway vehicles  Requirements for Rail Vehicle Structures	Issue 01 – 1 July 1994 (1 November 1994)  Issue 03 – 1 October 2000 (7 October 2002)  Issue 04 – 1 December 2010 (5 March 2011)  Issue 05 – 1 June 2012 (1 September 2012)
GM/RT2125	Fire Performance Requirements for Railway Vehicles	Issue 01 – 1 February 1996 (1 June 1996)
GM/RT2130 (superseded by RIS2730)	Vehicle Fire, Safety and Evacuation	Issue 01 – 1 June 2008 (2 August 2008)  Issue 02 – 1 August 2009 (3 October 2009)  Issue 03 – 1 December 2010 (5 March 2011)  Issue 04 – 7 December 2013 (1 March 2014)  Issue 05 – 6 June 2020 (6 June 2020)
GM/RT2456	Structural requirements for windscreen and windows on railway vehicles	Issue 02 – 1 April 2002 (3 June 2002)
GM/TT0080 (superseded by GM/RT2125)	Retaining and upgrading the fire performance of rolling stock	Issue 01 – 1 March 1993 (1 April 1993)
GM/TT0116 (superseded by GM/RT2120)	Fire Protection systems on Traction and Rolling stock	Issue 01 – 1 May 1993 (1 June 1993)
GO/OTS220	Emergency egress from passenger rolling stock	Issue 01 – 1 May 1993 (1 May 1993)
RIS2730RST	Vehicle Fire Safety and Evacuation	Issue 01 – 6 June 2020 (6 June 2020)



This page is intentionally left blank

---

This report is published by the Rail Accident Investigation Branch,  
Department for Transport.

© Crown copyright 2022

Any enquiries about this publication should be sent to:

RAIB	Email: <a href="mailto:enquiries@raib.gov.uk">enquiries@raib.gov.uk</a>
The Wharf	Telephone: 01332 253300
Stores Road	Website: <a href="http://www.gov.uk/raib">www.gov.uk/raib</a>
Derby UK	
DE21 4BA	