

TracFeed[®] DC-Products

Products and Services for the Power Supply
of DC Railways



Bringing people to their destinations safely and on time – with high performance and environmentally friendly Traction Powered Mass Transit Systems

This concern is fundamental to the innovative solutions of Rail Power Systems. As such, we aim to provide you with a smooth transition to the sustainable mobility of the future, using technical expertise and proven technical concepts.

The name Rail Power Systems stands for high performance railway infrastructure projects which reconcile ecological considerations with economic benefits. Energy efficiency, investment protection, easy and fast maintenance, the occupational health and safety initiatives and community responsibility are very important to us. In addition, Rail Power Systems is proud to offer a long service life, reliable quality, German manufacturing standards and high depth of integration.

Experienced experts from a range of specialist areas are always at our disposal. Our strategies and solutions are systematic and modular in their design, with tried and tested product platforms to meet customer requirements in a way that is economical while maintaining the highest quality standards.

Renowned partner for local mass transit operators

Today, a host of global transport operators run exemplary mass transit systems using DC power supplies. As operators, it is your task to design the reliable and economical regional and urban transportation of the future. This concern is fundamental to the innovative solutions of Rail Power Systems. As such, we aim to provide you with a smooth transition to the sustainable mobility of the future, using technical expertise and proven technical concepts. Rail Power Systems supports you with a perfectly matched portfolio.

- For trolleybus, tram, light rail, underground railway and metro systems
- For the installation of new lines or renovation (retrofit) and enhancement of existing infrastructure
- With studies for the system design
- From planning and supply to the commissioning of the switchgear panel technology
- Including service during operation until disposal

This brochure focuses on products for traction power supply. It also gives you an overview of other products and services from Rail Power Systems for mass transit systems.



Rail Power Systems combines all required components for the Complete Functional Solution

Rail Power Systems is an expert partner for design, installation and maintenance services to provide a complete infrastructure for local transport systems. We supply all required components and switchgear panels.

Do you need individual service modules? No problem! We also provide the appropriate solution for your requirements. In doing so, we match individual components (modules) with a regard for overall system efficiency. All components thus combine to form one optimum whole.

System studies	Station control technology	SCADA	Coupling cubicles
Disconnecter panels	Contact line switchgear panels	Circuit breaker panel	Rectifier
Contact line	Personal protection	Other electrical systems	Services



Turnkey substations – here for ViP Potsdam



Switchgear panel – assembled as needed



Catenary systems – with architecturally adapted design

TracFeed® DC-Products

Modular design and impressive system results: our key products for DC traction power supply

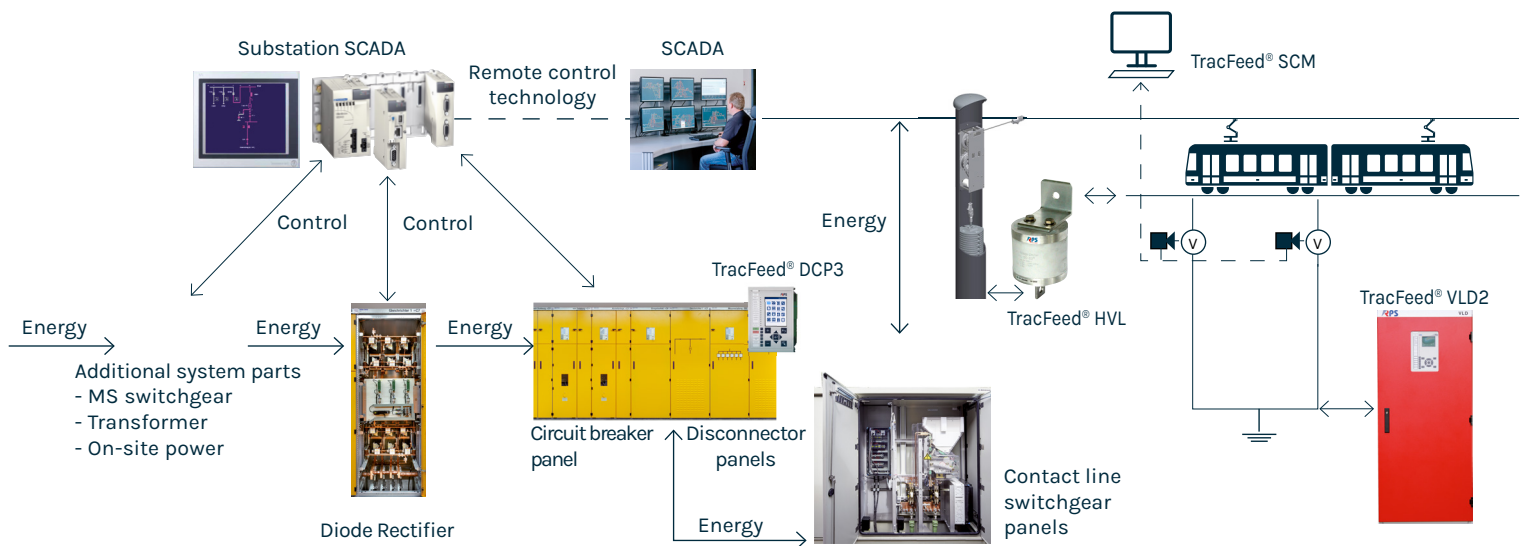

We support you from the basic design to the maiden voyage! ... and Service is Provided right up until the end of the line

We customise the designs and configurations of our detailed technical solutions to your needs. Whether it be components, switchboards or complete systems, long-term draft design or configurations, supply and turn-key handover of the total system, or professional maintenance and repairs with final disposal at the end of the product's service life: Rail Power Systems is always the most reliable partner for you.

- Rigorous systems analyses
- Core competences for the TracFeed® key products
- Tried and tested components and switchgear panels
- TracFeed® product platforms cover a wide range of individual requirements at low cost
- Complete service provision, all the way up to disassembly and proper disposal

Our Expertise – proven in challenging reference projects

Sustainable, reliable and ecologically responsible mobility represents one of the central challenges in many urban centres and the large metropolitan areas. Highly efficient local transport will play a prominent role today and tomorrow for the solution of these tasks.

Whether you are currently planning a comprehensive, large-scale future mass transit project, or rather concentrating on specific focus points, you can always rely on the expertise and depth of experience of Rail Power Systems' experts. We have proven our competency in a host of challenging reference projects, both in Germany and many other countries further afield. This means that you can be sure of support based on customised solutions geared towards your success.

System studies

System Design: The key to tailor-made traction power supply systems

The System Design department is your expert partner for optimal system solutions in the field of electrical railway infrastructure. This field is subject to stringent national directives and standards, which we comply with diligently and are constantly reviewing.

Our experienced specialist engineers analyse all the relevant factors that affect the railway system. They can draw on decades of experience, comprehensive technical knowledge and the latest simulation programs, which we are constantly refining.

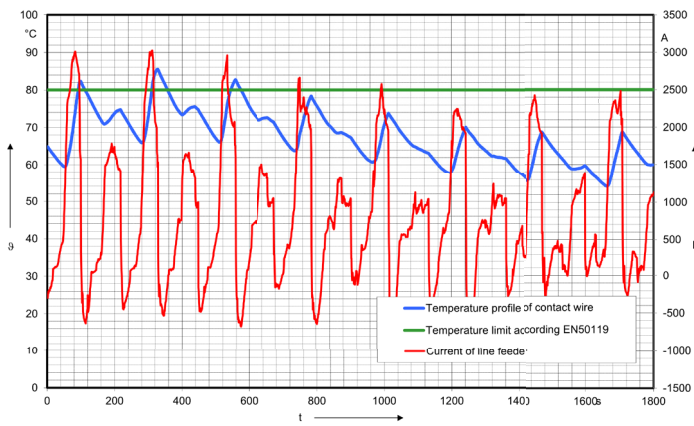

Temperature profile and load current of an overhead contact line with a catenary suspension

Requirements for the railway system with which the System Design department can help

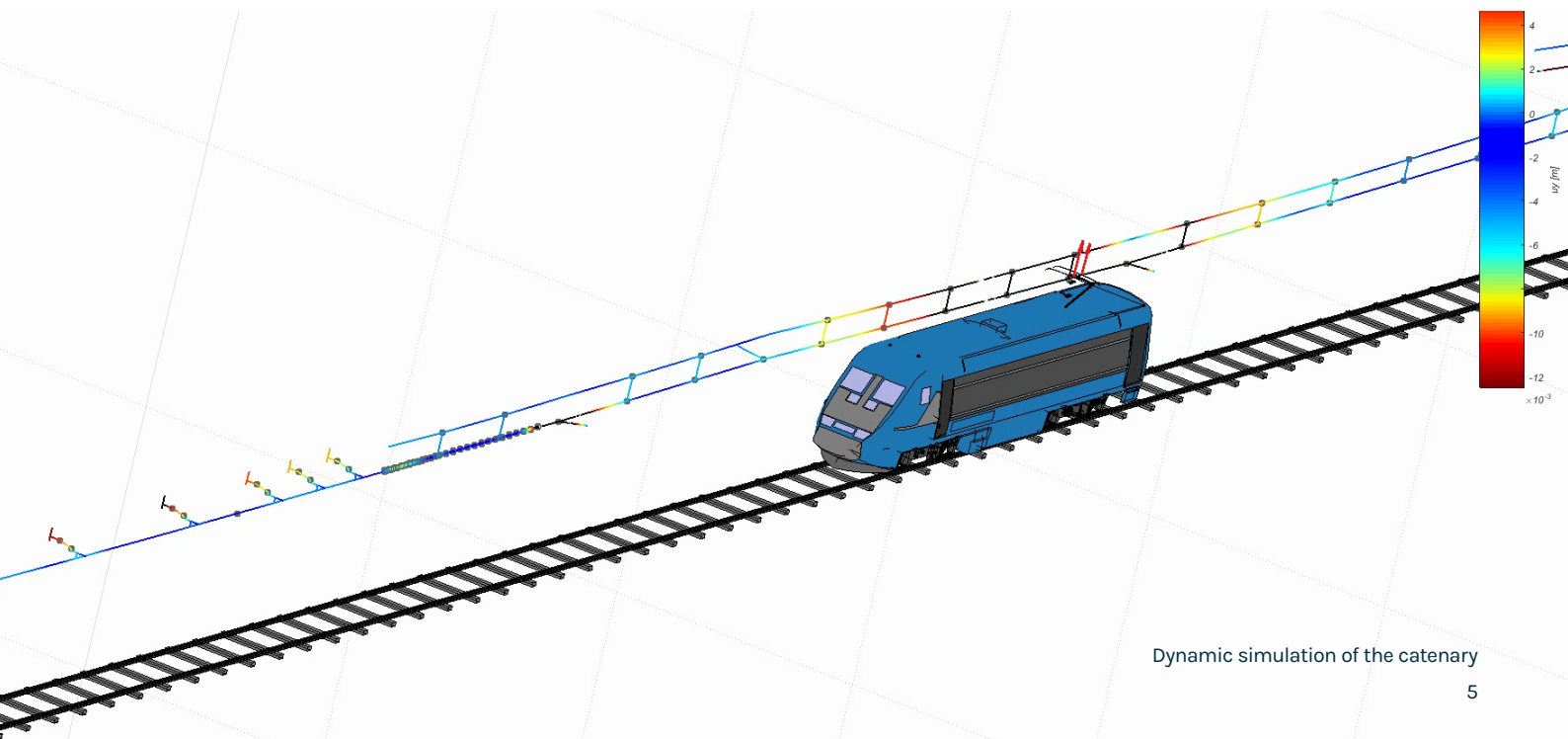
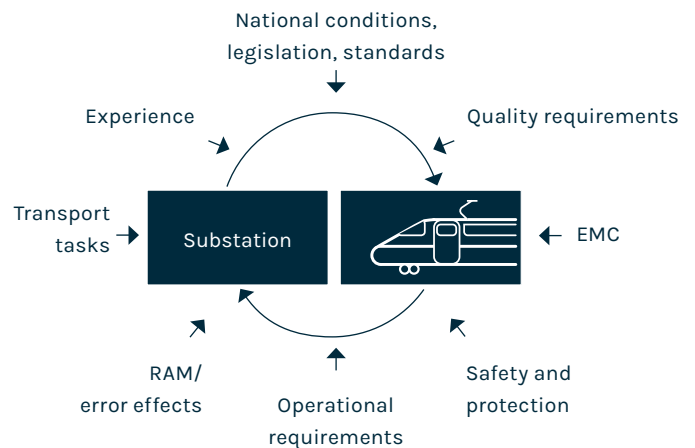

Dynamic simulation of the catenary

The System Design department covers a broad range of areas and plays a key role in ensuring that users of the infrastructure are able to enjoy reliable and safe mobility

• **Simulations, calculations and expert appraisals on:**

- Calculating the dynamic load flow of meshed networks
- Designing railway power supply systems
- Network changeovers (DC 600 V to DC 750 V)
- EMC pursuant to 26. BImSchV regulation
- Earthing and return current circuit
- Determining protection settings
- Dynamic simulation of overhead conductor rails and catenaries with TracFeed® OSSCAT

• **Measurement and inspection of:**

- Earthing measures
- EMC
- Stray current tests as per DIN EN 50122-2

• **Analysis of weak points & identifying possible solutions**

• **RAMS analyses**



Measurements of leakage coatings

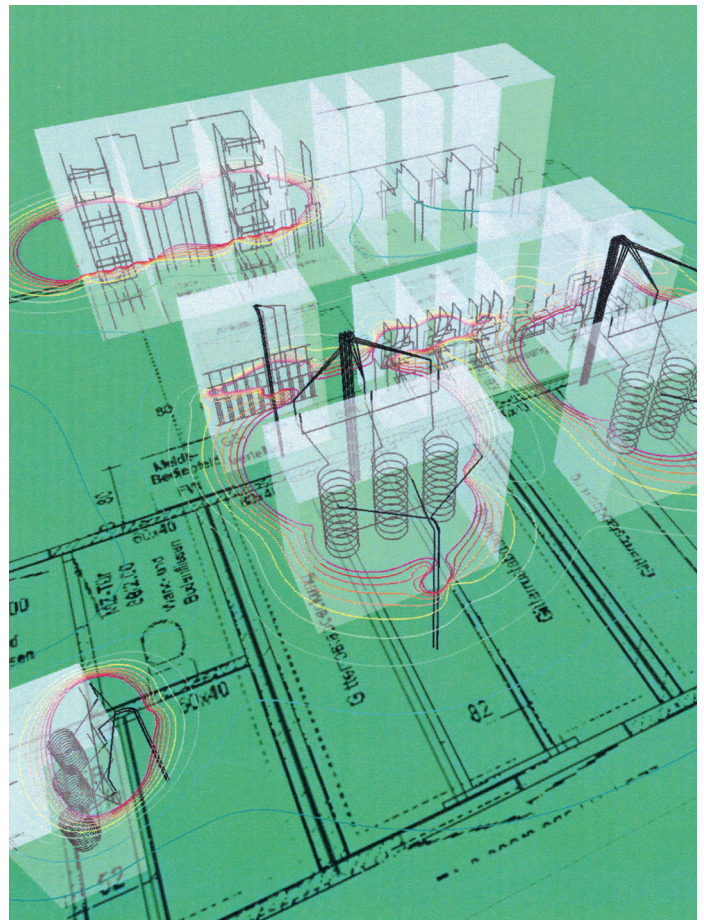

Calculations of electrical and magnetic fields for verification of compliance with thresholds in accordance with the 26th Federal Emission Control Act (BImSchG)

**How do we house your technology?
Whatever way you like!**

Rail Power Systems does not only design and supply technical systems but also provides equipment housing in accordance with your requirements. You can choose whether the new substation should be installed in existing substation buildings, or rather in new buildings, housings or adjoining areas, e.g. in a depot or in underground stations along the railway line.



Substation in factory-made steel container – e.g. for Vattenfall (DC 2.4 kV)



Substation in factory-made concrete container – e.g. for ViP Potsdam (DC 750 V)

Efficient: your DC substations in a Container Design

The quickly realisable building concept

The placement of the switchgear panels for the traction power supply in container substations is ideally suited to all applications where traction current needs to be provided quickly and with no time delays. Regardless of whether you wish to house your substations in concrete or steel containers, Rail Power Systems has the most efficient solutions for you. Your containers can already be prefabricated in the manufacturer's factory. Depending on the substation size and power, the construction is subdivided into one or several spatial units. Thus, large sub-stations can also be transported easily and installed, connected and commissioned on-site with minimal effort.

Supply of all equipment for efficient commissioning

All switchgear panels needed for operation in accordance with the customer specification are installed in container substations:

- Medium voltage switchboard
- Rectifier transformer
- Rectifier
- DC switchboard
- Control interface board
- Low voltage switchgear panel with
- Auxiliary transformer
- Lighting and heating
- Battery system

Fast installation, minimal commissioning time

The commissioning time after installation of the container can be minimised thanks to preinstalled and pretested equipment. After the external power cables and control cables are connected, your new container substation can go into operation in a few hours



Saves space and is not visible:
The traction power substation in the underground concrete container

Diode Rectifier TracFeed® TRx

The Heart Of the Energy Conversion Process: Power converters of the TracFeed® series

Power converters with air cooling play a central role in DC traction power supply. They rectify the supply side three-phase current.

TracFeed® GR diode rectifier fixed installation

Specific application scenario

Uncontrolled rectifiers with power diodes are the least expensive type of power converters. The rectifiers are designed for natural air cooling due to the low conduction losses of the power diodes used. With TracFeed® GR, you have the perfect product – with impressive features for economical and operational reliability.

A look at the characteristic data

The rectifiers are constructed from power converter modules, or so-called “power blocks”. Depending on the performance requirement and system voltage, they can be operated in parallel or in sequence:

- System voltages DC 750 V, DC 1 500 V, DC 3 000 V
- Disc-type diodes cooled on both sides
- Modular and compact design using power blocks
- Rectifier attenuation
- Easy access from the front for convenient maintenance

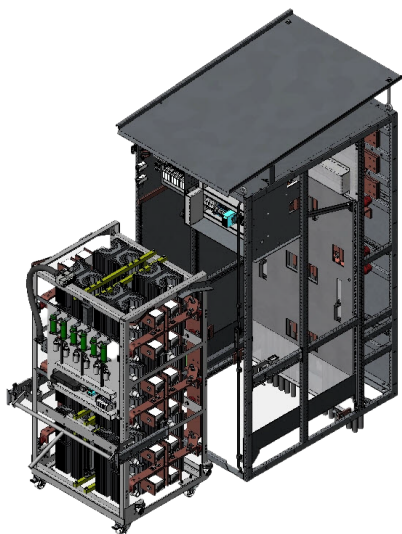

Construction model
withdrawable rectifier

Exceptionally reliable!

Your system operates best with power converters from Rail Power Systems. This is because your system fulfils the central requirements for:

- Large overload capability
- High blocking capacity
- High short circuit protection
- Low maintenance

... and as withdrawable version

Application

Withdrawable rectifiers open up more possibilities. The existing good accessibility for service work has been improved upon. The busbar and cable connection compartment is closed by a shutter for safety at work.

These converters are designed for high operating load peaks in accordance with the respective duty classes, with the ability to withstand frequent short circuits and overvoltage.

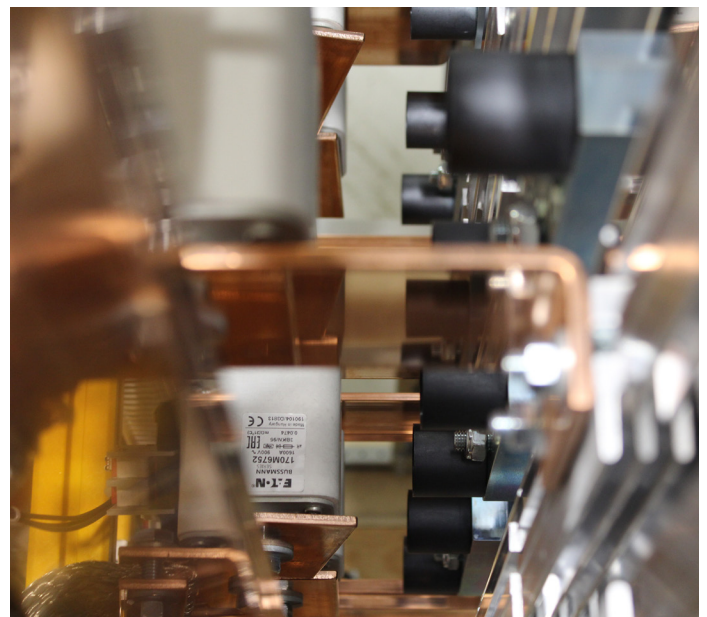

Power block type PB4/A – modular design, accessible from the front

TracFeed® TDx

Effortless Switching and control with the TracFeed® TDx brand switchgear panels

Rail Power Systems presents you with a, modularly designed product range of circuit breaker panels and disconnecter panels under the TracFeed® TDx brand name.

Variants

- Nominal voltages DC 750 V and DC 1500 V
- Busbar currents up to 10 000 A
- Main circuits up to 6 000 A

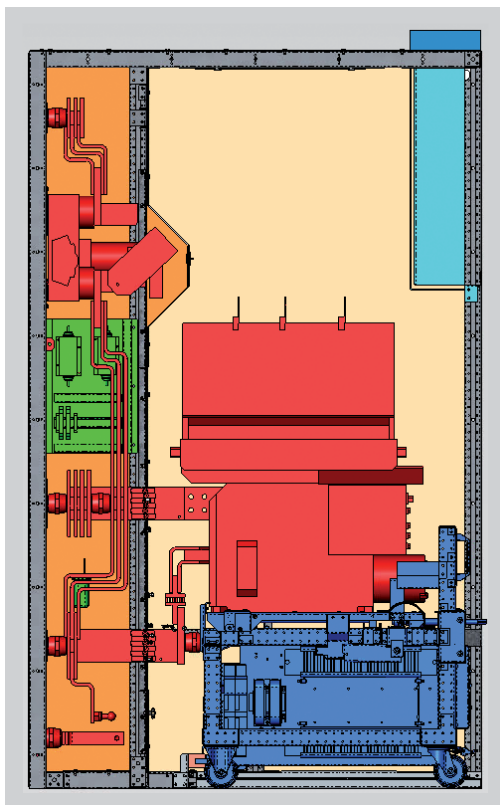

Circuit breaker panel

Basic application of the circuit breaker panels:

- Line feeder panel
- Bypass feeder panel
- Incomer panel

Options

A large selection of options is available. All common customer-specific requirements can thus be fulfilled.

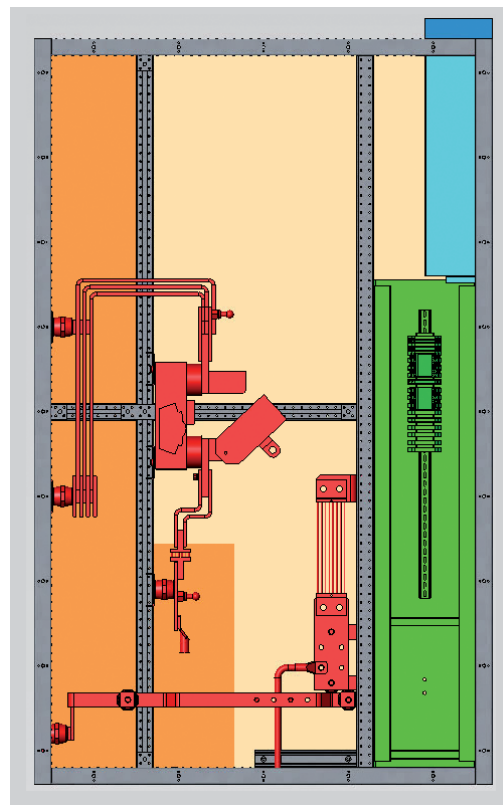

Disconnecter panel

Basic application of the disconnecter panels:

- Incomer panel
- Negative return panel
- Combined incomer and negative return panel

Control

Substation SCADA in every required bandwidth

The Substation SCADA enables control of the central substations. The spectrum ranges from the Ethernet field bus system for different communication protocols (including IEC 60870-5-104 or IEC 61850) to the optical fibre connected TracFeed® DCP2 and redundantly designed central PLC. The Substation SCADA also includes the interface to the control technology and is available in various power levels. An industrial PC as local SCADA enables the comfortable operation of the switchgear panels and the recording of the signals.

Should your substation SCADA also cover extensive special applications, e.g. for workshop (safety PLC for overhead work platforms etc.)?

If so, we provide the best solution!

Ultra-modern control system with TracFeed® SCADA

Rail Power Systems does not make any compromises when it comes to highly developed products for maintenance and control technology.

From control technology components to optical transmission paths and redundant lines to the control centre: when it comes to ultra-modern power management technology, we offer a wide range of solutions for the implementation of customised systems. As well as remote control connections according to international standards such as IEC 60870-5-101/-104, we can also integrate existing remote control lines with manufacturer-specific protocols. We attach particular importance to the design of the user interface for the process visualisation for the human-machine interface (HMI) - with a focus on user guidance and ease of use.

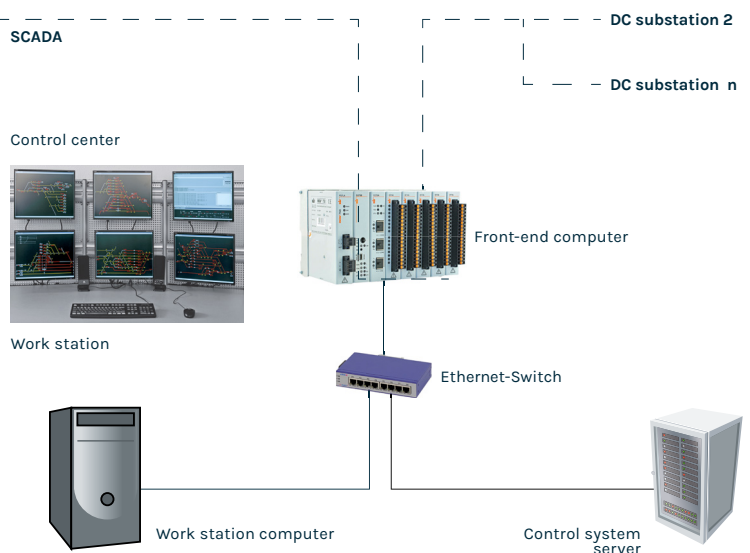
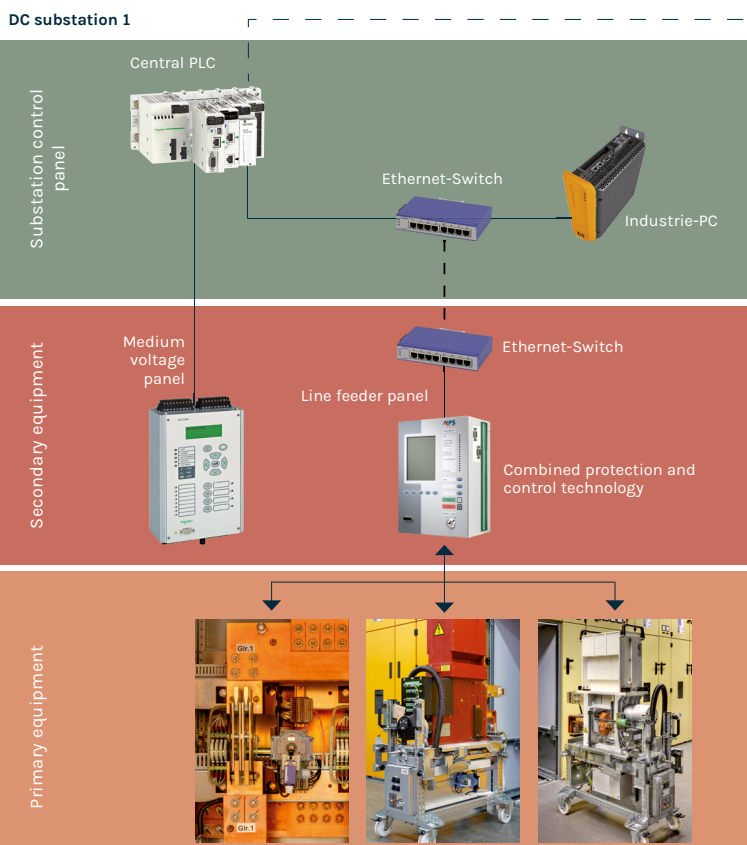

TracFeed® DCP3

Functions for the switchgear panels

The primary task of the DC switchgear as part of the traction power supply is feeding the traction energy to the contact line system. The contact line system is subdivided into feeder sections. This enables selective protection of the individual line section. Rail Power Systems uses the multifunctional devices of the TracFeed® DCP3 device family for all tasks concerning the line protection and switchgear panels and for control and communication.

Convenient display and operation

With its large display, the TracFeed® DCP3 visually presents all available information clearly. A graphic display shows a mimic diagram of the switching devices, which can also be selected and operated. Plain text displays can be called up using context-sensitive buttons, e.g. settings, measured values, event logs.

The coloured indicator lamps for display-independent signalling of important signals proven their efficiency over years of application. Assignment and major colour (red or green) of the LEDs can be set freely and adapted to your specific operating requirements.

Protection functions – just in case

The TracFeed® DCP3 protects your equipment using various protective functions operating simultaneously. These range from short circuit protection in the millisecond range to overload protection in the hour range.

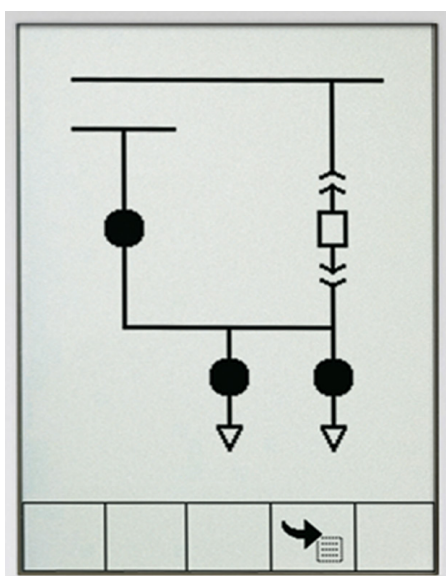

Switchboard protection



Always safely interlocked

Interlocking functions ensure reliable prevention of impermissible switching commands. This applies to all switching devices which are controlled by the TracFeed® DCP3.

Control functions

Control functions make it possible to reliably detect and execute the switching commands for electrically operated switching devices. In addition to the local control of a DC switchgear panel, remote control of the switching devices can also be performed easily. The integrated key switch enables the changeover between local control and remote control.

TracFeed[®] SCM

Stray Current Monitoring System

The return current circuit in DC railway systems is normally insulated by the earth potential. However, a complete insulation cannot be achieved. The proportion of the return current in the DC traction system stemming from the earth is considered stray current. It can cause corrosion and subsequent damage to metallic structures in the railway line and its environment. The overheating of protective earth connections and subsequent arcing and fire are further potential hazards that present risks to personal safety. Direct measuring and monitoring of stray current dissipation for a widely dispersed track is practically impossible. This is why the EN 50122-1 standard strongly recommends rail insulations be inspected using repeat

measurements or continuous monitoring of the rail potential. TracFeed[®] SCM provides the necessary continuous monitoring technology, rendering the need for complex and cost-intensive measurements by service personnel unnecessary.

Protect the infrastructure

The TracFeed[®] SCM monitors the insulation status of the infrastructure at all times. Measuring points along the line collect relevant data and send it to the central evaluation unit. This unit then collects, evaluates and visualises the measured data.

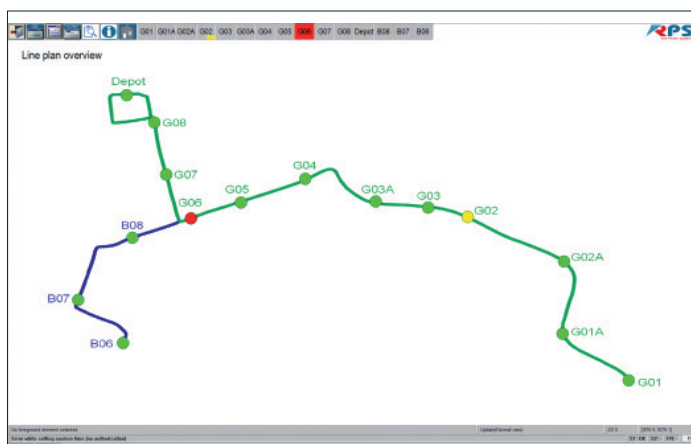
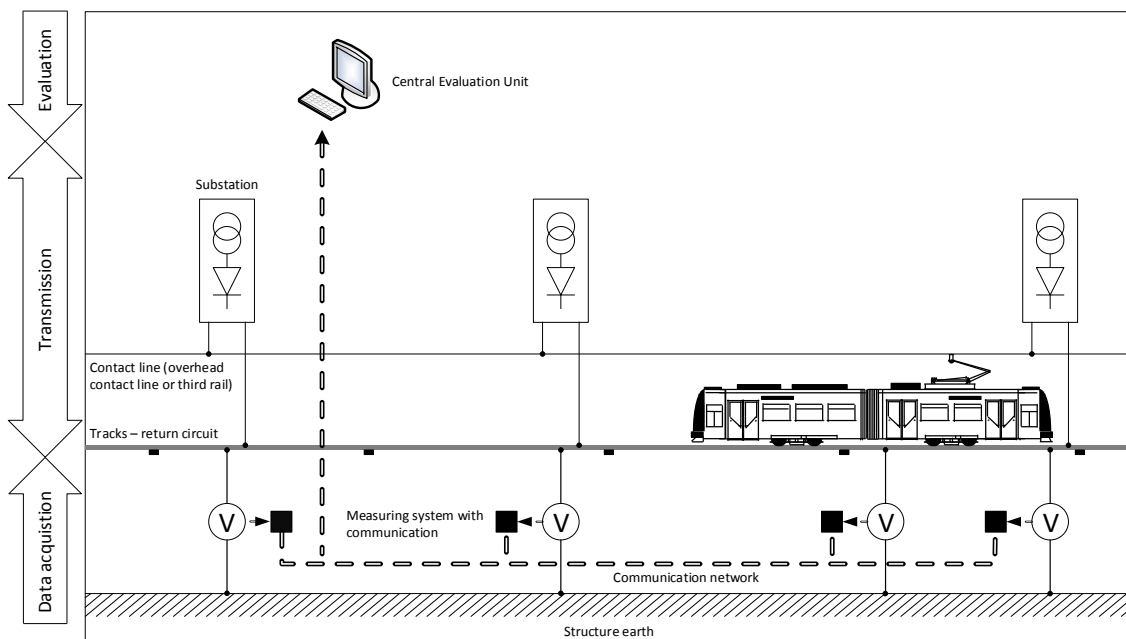

Complete overview

The user-friendly visualisation allows a fast overview of the insulation status of the infrastructure. TracFeed[®] SCM will provide immediate information on significant changes in the system. Thus, fast corrective action can be taken. Archiving functions help to observe changes over time and help to analyse the reasons for a fault.

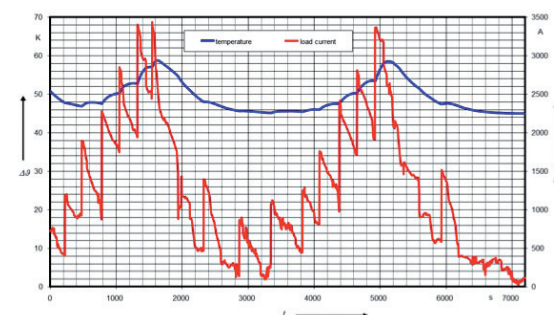

System studies

Energy-efficient networks

Energy-efficiency is always a pertinent and complex issue in connection with mass transit systems. The industry offers a number of interesting solutions, such as the use of energy storage on vehicles or stationary storage. Other solutions involve feeding back regenerative braking energy into the AC grid using power inverters.

However, Rail Power Systems questions this approach:

Which technical solution leads to the optimal life cycle costs for the customer's system?

The efficiency of traction substations with diode rectifiers is approximately 99 %. Therefore, the potential to increase efficiency is nearly exhausted. Future efficiency improvements of the DC system will primarily involve

- a system change from DC 600 V to DC 750 V
- the utilisation of the permissible voltage tolerance of the traction power network,
- useful feed concepts, and
- the use of braking energy with regenerative vehicles
- new systems or lines with DC 1500 V.

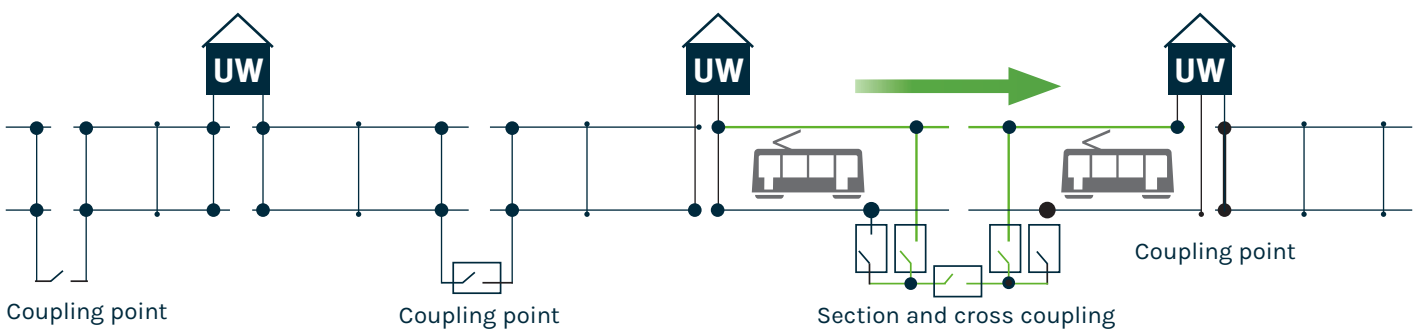

Braking energy: forwarding over track sections with coupling
Principal diagram of small decentralised substations with different feeding concepts

More DC Products

I TracFeed® OSC OUTDOOR SWITCHING CUBICLE

Outdoor switching cubicles are used as feeding point switches, or allow the coupling of line sections. Thus, the exchange of braking energy between the line sections is made possible and voltage stability is optimised. Different variations are available for the different tasks:

- -H = DC High-speed circuit breaker
- -L = Load break disconnecter
- -D = Disconnecter

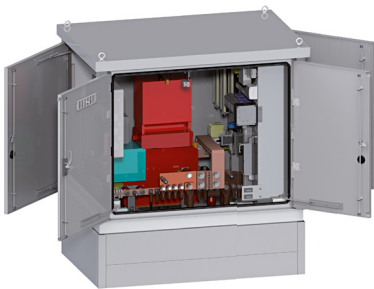

TracFeed® OSC-H with DC high-speed circuit breaker



TracFeed® OSC-L with load break disconnecter

Preventing risks with TracFeed® VLD2 ...

In DC traction power systems, dangerous voltages can arise between the negative return (running rails) and earth (structure earth). The causes for this are operating currents and short-circuit currents or faults in the installation. Inadmissible touch voltages are short-circuited by the TracFeed® voltage limiter, thereby preventing hazards to personal safety. Another option is the shutdown of the DC circuit breaker if the given voltage is the result of a high current.



TracFeed® VLD2

... and TracFeed® HVL

The TracFeed® HVL low-voltage limiter is a special component for protecting persons against inadmissible touch voltages.



TracFeed® HVL

Overhead contact line systems

Contact Line Systems - A Core Strength for Rail Power Systems

Rail Power Systems' portfolio also includes turn-key contact line systems. These are mainly designed and implemented using our own standard components in line with the customer's requirements.

Their applications range from mass transit (e.g. TracFeed® ALU1000) to high-speed main line systems (TracFeed® ALU3000), overhead contact lines, overhead conductor rails and third rails.

We are the expert partner that is always at your side, from the planning of your individual infrastructure, all the way to installation and commissioning. Our solutions fulfil the highest demands.



TracFeed® OSS Overhead conductor rail

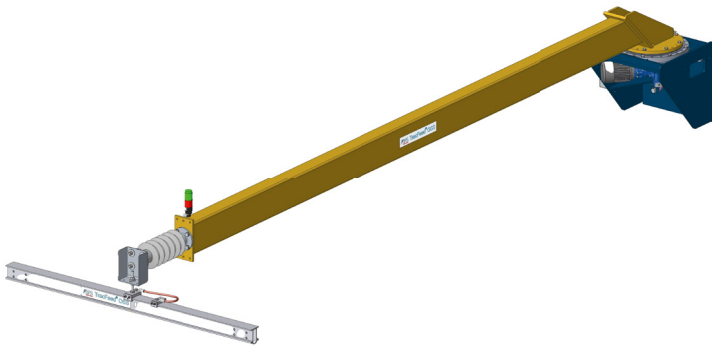

TracFeed® SAM Swivel arm for maintenance halls



TracFeed® NSV semi-integrated tension wheel



TracFeed® SFA motor drive

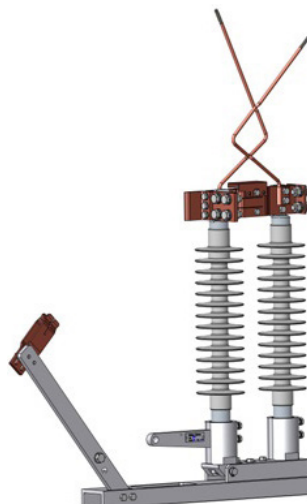

TracFeed® MTS disconnector

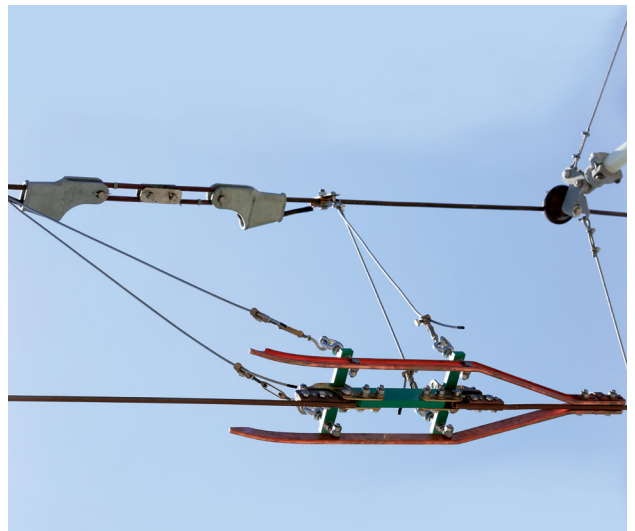

TracFeed® STR section insulator

I TracFeed® AEA

Experts for depots and workshops

Rail Power Systems provides important innovations and effective ideas for the long-term, fast and trouble-free maintenance of your DC railway system. We are on hand to provide our expertise for the interaction between your infrastructure and the rolling stock.

How can the DC switchgear panel and a downstream catenary switchgear panel for the supply of a depot be reliably controlled? How can additional advantages for personnel and equipment safety be guaranteed in the workshop using safety-oriented technology?

For these and many other questions, we are your trusted contact partner for making rail travel even more reliable and cost-effective.

TracFeed® AEA automatic switch-off and earthing system

Working near the overhead contact lines carries with it a number of risks. Maintenance and cleaning work on commuter trains or trams must be time-efficient while at the same time complying with the five safety rules so that no risks are posed to personnel. Therefore, a complete solution for the safety-oriented control and monitoring of the catenary system is indispensable, particularly in the work area.



Depot – here in the ICE works at Frankfurt-Griesheim with multi-voltage supply switchgear panel



Constant status information for the system and key-supported locking functions



TracFeed® AEA – assures the switch off and earthing of the catenary before work is begun

Services

Our Service department offers efficient system maintenance.

It provides essential, sustainable and long-term benefits, boosting the quality, performance and availability of switchgear technology. Based on our extensive experience we know that proactive expert service work brings about enormous savings. Time-consuming repairs and downtime are thus avoided throughout an entire service life.

The goal of our maintenance service team department is to keep switchgears:

- in optimal condition
- with the best possible availability

In aiming for this, economic factors are our central focus. Efficient service is our core strength, which gives the greatest possible support to our customers.

Our specially trained service personnel make it possible to quickly re-establish the availability of switchgears after a malfunction.

- Inspection/ maintenance of the substations according to the German regulations for the construction and operation of tramways (BOStrab) among other standards
- Inspection/ maintenance of all system components in the AC application range with 16.7 and 50Hz
- Service
- Improvement
- Implementing retrofitting measures in the DC and AC areas of railway technology
- Implementation of retrofit measures in the DC and AC area of traction current technology





RPS/EN/301/0824

© 2024. All rights reserved by Rail Power Systems GmbH.

The specifications set out in this document apply to conventional applications. They do not represent performance limits. This means that divergent specifications may be attained in specific applications. The contractually agreed specifications alone shall apply. We reserve the right to effect technical modifications.

TracFeed® is a registered trademark of Rail Power Systems GmbH.

Rail Power Systems GmbH

Garmischer Straße 35 | 81373 Munich | Germany | T +49 89 41999-0 | F +49 89 41999-270 | www.rail-ps.com